



Maura Healey, Governor  
Kimberley Driscoll, Lieutenant Governor  
Gina Fiandaca, Secretary & CEO  
Jonathan L. Gulliver, Highway Administrator



April 28, 2023

Ms. Tori Kim, Director  
Massachusetts Environmental Policy Act Office  
Executive Office of Energy and Environmental Affairs  
100 Cambridge Street, Suite 900  
Boston, MA 02114

RE: Cape Cod Bridges Program, Bourne, MA  
Environmental Notification Form

Dear Director Kim:

Pursuant to the Massachusetts Environmental Policy Act (MEPA) and its implementing regulations (301 CMR 11.03), the Highway Division of the Massachusetts Department of Transportation (MassDOT) is pleased to submit an Environmental Notification Form (ENF) for the Cape Cod Bridges Program in the town of Bourne, Massachusetts. The Cape Cod Bridges Program is a joint initiative among MassDOT and the New England District of the U.S. Army Corps of Engineers (USACE). It proposes critical transportation infrastructure improvements within the town of Bourne, with key elements including:

- Replacement of the existing Bourne and Sagamore Highway Bridges, which are owned, operated, and maintained by the USACE, as part of the Cape Cod Canal Federal Navigation Project,
- Reconfiguration of the highway approach networks north and south of Cape Cod Canal to align with the replacement highway bridges, and
- Construction of new accessible pedestrian and bicycle connections to the local roadway network.

With this submittal, MassDOT is requesting that your office publish the Cape Cod Bridges Program ENF in the May 10<sup>th</sup> edition of the Environmental Monitor. Due to the substantial public interest in the Program, MassDOT is requesting an extension of the public review period to June 27, 2023. Accordingly, the issuance of your decision on the ENF would be extended to July 7, 2023.

To further inform the public in advance of the comment due date, MassDOT will host two open house style meetings. The meetings will take place at the Bourne Veteran's Memorial Community Center, 239 Main St, Buzzards Bay, MA 02532 on May 17, 2023, afternoon (12-3 p.m.) and evening (5-8 p.m.). At these meetings, MassDOT will be available to provide information specific to the materials presented in the ENF.

We look forward to working with your office during the ENF review and development of the Draft Environmental Impact Report for the Cape Cod Bridges Program. Please contact MassDOT's Program Manager, Bryan Cordeiro, at (774)993-9632 or [Bryan.Cordeiro@dot.state.ma.us](mailto:Bryan.Cordeiro@dot.state.ma.us) should you have any questions or if you would like to further discuss the Cape Cod Bridges Program.

Sincerely,

Carrie Lavalley, P.E.  
Deputy Administrator and Chief Engineer



**DEPARTMENT OF THE ARMY**  
**U.S. ARMY CORPS OF ENGINEERS**  
**NEW ENGLAND DISTRICT**  
**696 VIRGINIA ROAD**  
**CONCORD, MA 01742-2751**

April 26, 2023

Ms. Tori Kim, Director  
Massachusetts Environmental Policy Act Office  
Executive Office of Energy and Environmental Affairs  
100 Cambridge Street, Suite 900  
Boston, MA 02114

RE: Cape Cod Bridges Program, Bourne, MA Environmental Notification Form

Dear Director Kim:

The New England District of the United States Army Corps of Engineers (USACE) is pleased to support the Highway Division of the Massachusetts Department of Transportation (MassDOT) in the filing of the Environmental Notification Form (ENF) for the Cape Cod Bridges Program. The Program is a joint initiative among MassDOT and the USACE. It proposes critical transportation infrastructure improvements within the town of Bourne, with key elements including:

- Replacement of the existing Bourne and Sagamore Highway Bridges, which are owned, operated, and maintained by the USACE, as part of the Cape Cod Canal Federal Navigation Project,
- Reconfiguration of the highway approach networks north and south of Cape Cod Canal to align with the replacement highway bridges, and
- Construction of new accessible pedestrian and bicycle connections to the local roadway network.

The USACE supports MassDOT's request that your office publish the Cape Cod Bridges Program ENF in the May 10<sup>th</sup> edition of the Environmental Monitor and extend the public review period to June 27, 2023.

We look forward to our continued partnership with MassDOT and supporting them as they work with your office during the ENF review and development of the Draft Environmental Impact Report for the Cape Cod Bridges Program. Please contact USACE's Program Manager, Craig Martin, at (978) 318-8638 or [Craig.A.Martin@usace.army.mil](mailto:Craig.A.Martin@usace.army.mil) should you have any questions or if you would like to further discuss USACE's role in Cape Cod Bridges Program.

Sincerely,

A handwritten signature in blue ink, appearing to read "Scott Acone".

Scott Acone, P.E., PMP  
Programs and Project Management Division  
United States Army Corps of Engineers



**Cape Cod Bridges Program  
Bourne, Massachusetts**

# Environmental Notification Form

**massDOT**  
Massachusetts Department of Transportation

**SUBMITTED TO:**

The Executive Office of Energy and Environmental Affairs  
MEPA Office  
100 Cambridge Street, Suite 900  
Boston, MA 02114

**PROPONENT:**

The Massachusetts Department of Transportation  
Highway Division  
10 Park Plaza  
Boston, MA 02116

**April 28, 2023**

# Introduction to the Environmental Notification Form

The Massachusetts Department of Transportation, Highway Division (MassDOT) is submitting the enclosed Environmental Notification Form (ENF) to the Secretary of the Massachusetts Executive Office of Energy and Environmental Affairs (EEA) for proposed advancement of the Cape Cod Bridges Program (the Program) in the town of Bourne, Massachusetts, pursuant to the Massachusetts Environmental Policy Act (MEPA) and its implementing regulations (301 CMR 11.00). The Program, which is a joint initiative among MassDOT, the Federal Highway Administration (FHWA) and the New England District of the U.S. Army Corps of Engineers (USACE), proposes critical transportation infrastructure improvements within the town of Bourne, with key elements including:

- Replacement of the existing Bourne and Sagamore Highway Bridges, which are owned, operated, and maintained by the USACE, as part of the Cape Cod Canal Federal Navigation Project (FNP),
- Reconfiguration of the highway approach networks north and south of Cape Cod Canal to align with the replacement highway bridges, and
- Construction of new accessible pedestrian and bicycle connections to the local roadway network.

The Program draws from prior studies, including the USACE's March 2020 Cape Cod Canal Highway Bridges Major Rehabilitation Evaluation Report (MRER) and the MassDOT Office of Transportation Planning (OTP) October 2019 Cape Cod Canal Transportation Study, that addressed the deteriorating performance of the aging Bourne and Sagamore Highway Bridges and the multimodal transportation deficiencies of the surrounding approach roadway networks. Building upon the analyses and findings of the March 2020 Cape Cod Canal Highway Bridges MRER, and in coordination with USACE and FHWA, the Program will incorporate the USACE's decision to replace both the Bourne and Sagamore highway bridges with new adjacent bridges structures (each providing four through-traffic lanes and two auxiliary acceleration/deceleration lanes), updated to comply with current state and federal highway design standards.

The ENF presents MassDOT's screening methodologies to arrive at preferred options for main span length and bridge pier location, bridge deck configuration, bridge type, and highway bridge mainline alignment location over Cape Cod Canal. The ENF also identifies and evaluates the impacts of ten interchange approach alternatives for the replacement bridges based on conceptual design. MassDOT proposes to conduct additional design and secondary screening of the ten alternatives to identify a single set of interchange pairings (Preferred Alternative) for each bridge crossing. The results of the secondary screening of the ten interchange approach alternatives and determination of the Preferred Alternative for each crossing will be presented in a subsequent Draft Environmental Impact Report (DEIR) filing with the MEPA Office.

# Table of Contents

## Environmental Notification Form

### Attachment 1: Program Narrative

### Attachment 2: ENF Distribution List

### Attachment 3: List of Anticipated Approvals and Permits

### Attachment 4: Alternatives Analysis Report

### Attachment 5: Traffic Documentation

- 5.1 Existing 2019 Conditions Traffic Analysis
- 5.2 Summary of Future No Build Modeling Process and Results (Draft)

### Attachment 6: Environmental Documentation and Agency Coordination

- 6.1 Bourne Priority Habitats and Estimated Habitats Map, NHESP 15th Edition Natural Heritage Atlas
- 6.2 Previous USFWS Coordination
- 6.3 Previous NMFS Coordination
- 6.4 Previous EPA Coordination
- 6.5 Previous CZM Coordination

### Attachment 7: Historic Agency and Tribal Consultation and Documentation

- 7.1 Previous Historic Agency and Tribal Consultation
- 7.2 Programmatic Agreement between the USACE and the MA SHPO, March 11, 2022

### Attachment 8: RMA Climate Resilience Design Standards Reports

- 8.1 Bourne Bridge Replacement RMA Report
- 8.2 Sagamore Bridge Replacement RMA Report

### Attachment 9: Environmental Justice and Public Involvement Documentation

- 9.1 Environmental Justice Screening Form and Documentation
- 9.2 Cape Cod Bridges Program Public Involvement Plan, March 2023
- 9.3 Cape Cod Bridge Program FAQs
- 9.4 Cape Cod Bridges Program Round 4 FAQs

**Commonwealth of Massachusetts**  
**Executive Office of Energy and Environmental Affairs**  
**Massachusetts Environmental Policy Act (MEPA) Office**

**Environmental Notification Form**

*For Office Use Only*

EEA#: \_\_\_\_\_

MEPA Analyst: \_\_\_\_\_

*The information requested on this form must be completed in order to submit a document electronically for review under the Massachusetts Environmental Policy Act, 301 CMR 11.00.*

<b>Project Name: Cape Cod Bridges Program</b>		
<b>Street Address: Bourne and Sagamore Bridges and highway approach networks</b>		
<b>Municipality: Bourne, MA</b>	<b>Watershed: Cape Cod, Buzzards Bay, South Coastal</b>	
<b>Universal Transverse Mercator Coordinates:</b> <b>Bourne: Zone 19, 371730.61 Easting, 4626079.58 Northing</b> <b>Sagamore: Zone 19, 367824.30 Easting, 4622996.47 Northing</b>	<b>Latitude: 41.7478°N (Bourne); 41.7762°N (Sagamore)</b> <b>Longitude: 70.5897°W (Bourne); 70.5434°W (Sagamore)</b>	
<b>Estimated commencement date: 2027</b>	<b>Estimated completion date: 2035</b>	
<b>Project Type: Transportation</b>	<b>Status of project design: Preliminary Design</b>	
<b>Proponent: Massachusetts Department of Transportation, Highway Division (MassDOT)</b>		
<b>Street Address: 10 Park Plaza</b>		
<b>Municipality: Boston</b>	<b>State: MA</b>	<b>Zip Code: 02116</b>
<b>Name of Contact Person: Mark Kolonoski</b>		
<b>Firm/Agency: HNTB</b>	<b>Street Address: 31 St. James Avenue</b>	
<b>Municipality: Boston</b>	<b>State: MA</b>	<b>Zip Code: 02116</b>
<b>Phone: (617) 532-2351</b>	<b>Fax:</b>	<b>E-mail: mkolonoski@hntb.com</b>

Does this project meet or exceed a mandatory EIR threshold (see 301 CMR 11.03)?

Yes  No

If this is an Expanded Environmental Notification Form (ENF) (see 301 CMR 11.05(7)) or a Notice of Project Change (NPC), are you requesting:

a Single EIR? (see 301 CMR 11.06(8))

Yes  No

a Rollover EIR? (see 301 CMR 11.06(13))

Yes  No

a Special Review Procedure? (see 301 CMR 11.09)

Yes  No

a Waiver of mandatory EIR? (see 301 CMR 11.11)

Yes  No

a Phase I Waiver? (see 301 CMR 11.11)

Yes  No

(Note: Greenhouse Gas Emissions analysis must be included in the Expanded ENF.)

Which MEPA review threshold(s) does the project meet or exceed (see 301 CMR 11.03)?

- **301 CMR 11.03(1)(a)1. – Direct alteration of 50 or more acres of land.**
- **301 CMR 11.03(1)(a)2. – Creation of ten or more acres of impervious area.**
- **301 CMR 11.03(6)(b)1. b. – widening of an existing roadway by four or more feet for one-half or more miles, excluding widening to add bicycle or pedestrian accommodations.**
- **301 CMR 11.03(6)(b)2. a. – Construction, widening, or maintenance of a roadway or its right-of-way that will alter the bank or terrain located ten more feet from the existing roadway for one-half or more miles.**
- **301 CMR 11.03(6)(b)2. b. – Construction, widening, or maintenance of a roadway or its right-of-way that will cut five or more living public shade trees of 14 or more inches in diameter at breast height.**

Which State Agency Permits will the project require?

- **401 Water Quality Certificate, Massachusetts Department of Environmental Protection**
- **Chapter 91 Waterways Licenses, Massachusetts Department of Environmental Protection**
- **State Archaeologist Permit, Massachusetts Historical Commission**

**Note: The need for a Massachusetts Endangered Species Act (MESA) Conservation and Management Permit (CMP) will be determined upon further consultation with the Natural Heritage and Endangered Species Program (NHSEP) of the Massachusetts Division of Fisheries and Wildlife.**

Identify any financial assistance or land transfer from an Agency of the Commonwealth, including the Agency name and the amount of funding or land area in acres: **The Program will be supported in part with state funds from MassDOT. The 2021 Transportation Bond Bill authorized the investment of \$350 million to support infrastructure improvements associated with the Cape Cod Canal Bridges. The Program is not anticipated to require any land transfer from an Agency of the Commonwealth.**

<b>Summary of Project Size &amp; Environmental Impacts</b>	<b>Existing</b>	<b>Change</b>	<b>Total</b>
<b>LAND</b>			
Total site acreage	<b>835.8</b>		
New acres of land altered		<b>Up to 168 acres</b>	
Acres of impervious area	<b>136.8</b>	<b>+ 29.1</b>	<b>165.9</b>
Square feet of new bordering vegetated wetlands alteration		<b>TBD</b>	
Square feet of new other wetland alteration		<b>Buffer Zone: Up to 38,000 sf Isolated Land Subject to Flooding: Up to 5,200 sf</b>	
Acres of new non-water dependent use of tidelands or waterways		<b>n/a</b>	
<b>STRUCTURES</b>			
Gross square footage	<b>144,300 sf – Bourne Bridge 98,600 sf – Sagamore Bridge</b>	<b>+580,400 sf – Bourne Bridge  + 311,500 sf – Sagamore Bridge</b>	<b>724,700 sf – Bourne Bridge 410,000 sf – Sagamore Bridge</b>
Number of housing units			
Maximum height (feet) - Bridges	<b>135' above MHW (NAVD88)</b>	<b>3'</b>	<b>138' above MHW (NAVD88)</b>
<b>TRANSPORTATION</b>			
Vehicle trips per day <sup>1</sup>	<b>46,380 – Bourne Bridge 62,030 – Sagamore Bridge</b>	<b>TBD</b>	<b>TBD</b>
Parking spaces	<b>n/a</b>	<b>n/a</b>	<b>n/a</b>
<b>WASTEWATER</b>			
Water Use (Gallons per day)	<b>n/a</b>	<b>n/a</b>	<b>n/a</b>
Water withdrawal (GPD)	<b>n/a</b>	<b>n/a</b>	<b>n/a</b>
Wastewater generation/treatment (GPD)	<b>n/a</b>	<b>n/a</b>	<b>n/a</b>
Length of water mains (miles)	<b>n/a</b>	<b>n/a</b>	<b>n/a</b>
Length of sewer mains (miles)	<b>n/a</b>	<b>n/a</b>	<b>n/a</b>

<sup>1</sup> The existing Average Daily Traffic (ADT) for the Bourne and Sagamore using Fall 2019 data; Traffic modeling is ongoing with results to be presented in the DEIR.



Has this project been filed with MEPA before?

Yes (EEA # \_\_\_\_\_)  No

Has any project on this site been filed with MEPA before?

Yes (EEA # \_\_\_\_\_)  No

## **GENERAL PROJECT INFORMATION – all proponents must fill out this section**

### **PROJECT DESCRIPTION:**

MassDOT, in partnership with the Federal Highway Administration (FHWA) and the New England District of the U.S. Army Corps of Engineers (USACE), proposes advancement of the Cape Cod Bridges Program (Program) in the town of Bourne, Barnstable County, Massachusetts. The purpose of the Program is to improve cross-canal mobility and accessibility between Cape Cod and mainland Massachusetts for all road users and to address the increasing maintenance needs and functional obsolescence of the aging Bourne and Sagamore highway bridges, which are owned, operated, and maintained by the USACE, as part of the Cape Cod Canal Federal Navigation Project.

The Program proposes replacement of the Bourne and Sagamore highway bridges and reconfiguration of the highway approach networks north and south of the Cape Cod Canal to align with the replacement highway bridges. The replacement bridges, and their interchange approaches will accommodate shared use pedestrian and bicycle paths that connect to the local roadway network on both sides of Cape Cod Canal in the town of Bourne.

A Memorandum of Understanding (MOU) was executed between the USACE and MassDOT regarding the Bourne and Sagamore highway bridges on July 7, 2020. According to the terms of the agreement, the USACE will continue to own, operate, and maintain the existing Bourne and Sagamore highway bridges and MassDOT will lead Program delivery with responsibility to construct and subsequently own, operate and maintain the replacement highway bridges and approaches as part of the Commonwealth's network of roads and bridges. MassDOT will work in partnership with FHWA and USACE to pursue all possible avenues of Program funding for these critical public roadway infrastructure improvements in the town of Bourne.

Describe the existing conditions and land uses on the project site:

#### ***Bourne and Sagamore Bridges***

The Bourne and Sagamore bridges are two high level, fixed span highway bridges over Cape Cod Canal. Identical in design, each highway bridge provides four 10-foot-wide vehicular travel lanes (two lanes in each direction) with a double yellow centerline, and a single 5-foot-wide sidewalk. A two-foot-wide safety curb is provided along the side opposite the sidewalk. Each bridge provides a 135-foot vertical clearance over mean high water (MHW) and a 500-foot horizontal clearance. The bridges were constructed beginning in 1933, when Cape Cod Canal was widened, and opened to traffic in 1935, replacing two original low-level drawbridges.

The Bourne and Sagamore bridges are the only vehicular access points from Cape Cod to mainland Massachusetts, serving as essential routes for general transportation, freight distribution, emergency response, tourism, and access to major national defense facilities at Joint Base Cape Cod in the upper western portion of Cape Cod. After nearly 90 years of continuous traffic use, the bridges have deteriorated over time and require frequent repairs with associated lane closures that are highly disruptive to traffic and access by emergency responders crossing Cape Cod Canal. In addition to escalating maintenance

issues, the aging Bourne and Sagamore bridges do not meet current design and safety standards due to their narrow travel lanes, lack of shoulders, and physical separation between opposing traffic lanes and lack of accessible accommodations for pedestrian and bicyclists.

#### **Program Study Areas and Existing Roadway Facilities**

There are two study areas defined for the Program, the Bourne Program Study Area and the Sagamore Program Study Area, which include the areas of the existing Bourne and Sagamore bridges and highway approach intersections for each crossing. Refer to Attachment 1, Figures 1-2 and 1-3 for maps illustrating the limits of the Program Study Areas.

The Bourne Program Study Area includes the Route 25 and Route 28 approaches to the Bourne Bridge. North of Cape Cod Canal, roadways within the Bourne Program Study Area include Route 6 (Scenic Highway) and the roadways approaching Belmont Circle, including the Route 25 exit- and entrance-ramps and portions of the Head of the Bay Road, Main Street, and the Buzzards Bay Bypass. South of the canal, roadways within the Bourne Program Study Area include the Bourne Rotary and approach roadways, consisting of Route 28, Sandwich Road, Trowbridge Road, Veterans Way, and the Bourne Rotary Connector.

The Sagamore Program Study Area includes the Route 3 and Route 6 approaches to the Sagamore bridge. North of Cape Cod Canal, roadways within the Sagamore Program Study Area include the Scenic Highway and Meetinghouse Lane approaches, the Route 3/Scenic Highway interchange, and portions of Canal Street and State Road. South of the canal, roadways within the Program Study Area include Cranberry Highway, Sandwich Road and Route 6 itself, extending south of the Mid-Cape Connector ramps to Route 6.

Refer to Attachment 1, Section 6 for details on the existing transportation network in the Program Study Areas.

#### **Existing Environmental Conditions**

The following sections provide an overview of environmental resources and land uses within the Program Study Areas.

***Wetlands, Water Resources and Floodplain:*** Wetland and water resources within the Sagamore Program Study Area are limited to Cape Cod Canal and a small freshwater wetland north of Cape Cod Canal, approximately 500 feet east of the Route 3 southbound approach to the Sagamore Bridge. Areas of 100-year floodplain do not extend outside of Cape Cod Canal within the Sagamore Program Study Area.

Wetland and water resources within the Bourne Program Study Area include Cape Cod Canal and Nightingale Pond, which is approximately 1,800 feet north of Cape Cod Canal and approximately 100 feet east of Route 25. Several freshwater wetland areas exist within the Route 25 exit ramps and Belmont Circle, north of Cape Cod Canal. Areas of 100-year floodplain extend beyond the banks of Cape Cod Canal west of the Bourne Bridge. North of Cape Cod Canal, the 100-year floodplain extends from Nightingale Pond to Bourne Pond, encompassing portions of Route 6, Belmont Circle, and Main Street. The 100-year floodplain extends up to 750-feet south of Cape Cod Canal.

Refer to Attachment 1, Figures 5-1 through 5-4 for mapping of wetlands, water resources and floodplain within the Program Study Areas.

***Areas of Critical Environmental Concern:*** Areas of Critical Concern (ACECs) are places in Massachusetts that receive special recognition because of the quality, uniqueness, and significance of their natural and cultural resources. The Sagamore Program Study Area includes portions of the Herring River Watershed ACEC, as shown in Attachment 1, Figure 3-7. No ACECs are included within the Bourne Program Study Area.

***Rare Species Habitat:*** According to the Massachusetts Natural Heritage and Endangered Species Program (NHESP) 15th Edition Natural Heritage Atlas (August 2021), state-designated rare species habitat is mapped within the Sagamore Program Study Area to the east and west of Route 6 (Mid Cape Highway), south of Cape Cod Canal, encompassing both the Upper Cape Water Reserve within Joint Base Cape Cod and the Shawme-Crowell State Forest (and the electrical utility corridor that bisects the state forest). There is no state-designated rare species habitat within the Sagamore Program Study Area north of Cape Cod Canal. The Bourne Program Study Area is mapped within state-designated rare species habitat, approximately 1,700 feet south of the Bourne Rotary, east of Route 28. Refer to Attachment 1, Figures 4-1 and 4-2 for mapping of state designated rare species habitat within the Program Study Areas.

***Land Use and Protected Open Space:*** The Bourne and Sagamore Program Study Areas encompass a variety of land uses including residential and commercial properties, forested land, and impervious cover associated with the roadway right-of-way, as shown in Attachment 1, Figures 3-1 through 3-4. There are also multiple properties designated as publicly owned and protected open space within the Bourne and Sagamore Program Study Areas, as shown in Attachment 1, Figures 3-5 through 3-8.

The USACE owns and operates many of the open space properties immediately adjacent to the Bourne and Sagamore bridges and Cape Cod Canal. North of Cape Cod Canal, protected open space properties within the Bourne Program Study Area include the Bourne Scenic Park and Nightingale Pond Conservation Area, owned by the Town of Bourne. South of Cape Cod Canal, protected open space properties within the Bourne Program Study Area include the Sandwich Road Conservation Area and the Bourne High School Recreational Fields, owned by the Town of Bourne.

The Camp Edwards Management Wildlife Area/The Upper Cape Water Reserve within Joint Base Cape Cod and the Shawme-Crowell State Forest are within the Sagamore Program Study Area, south of Cape Cod Canal. These parcels are owned by the Commonwealth of Massachusetts and afforded special resource protection under Article 97 of the Amendments to the Massachusetts Constitution.

***Coastal Zone:*** The Bourne and Sagamore Program Study Areas, as well as all of Cape Cod, are mapped within the Massachusetts coastal zone boundary.

Describe the proposed project and its programmatic and physical elements:

MassDOT proposes to replace the Bourne and Sagamore highway bridges with parallel, twin network tied-arch bridge structures supported on Delta frames with an approximate 700-foot mainline span length. Both bridges would be replaced in the same general location, but fully outside the footprint of the existing bridges and on the side of the canal between the existing Bourne and Sagamore bridges.

The replacement highway bridges and their approach networks would comply with current MassDOT and FHWA design criteria and American Association of State Highway and Transportation Officials (AASHTO) highway safety standards. The two parallel bridge structures (barrels) at each crossing would provide two 12-foot-wide through travel lanes, a 12-foot-wide entrance/exit (auxiliary) lane, a 4-foot-wide left shoulder, and a 10-foot-wide right shoulder. Additionally, each bridge crossing would include one bi-directional pedestrian and bicycle shared use path, separated from vehicular traffic by the shoulder and barrier.

For each crossing, MassDOT proposes to reconfigure the highway approach networks north and south of Cape Cod Canal to align with the replacement highway bridges, including reducing the vertical grades of the replacement bridges and their approaches at each crossing. MassDOT has screened conceptual interchange approach options for each crossing, including multi-modal connections with local roadways. Based on conceptual design, MassDOT has identified ten interchange approach alternatives, consisting of

three alternatives for Bourne North, two alternatives for Bourne South, two alternatives for Sagamore North, and three alternatives for Sagamore South. MassDOT proposes further design and environmental evaluation to identify the preferred interchange approach alternative (interchange pairing) for each crossing.

MassDOT is designing the replacement highway bridges to maintain navigation through Cape Cod Canal, per USACE requirements. MassDOT is proposing to maintain the existing highway bridges' minimum horizontal clearance of 500 feet and vertical clearance of 135 feet above MHW, originally authorized by Congress. Supporting an approximate 700-foot main span, the bridge piers would be placed in the rip rap slope of Cape Cod Canal and above the low tide line, well outside the navigation channel. To account for future sea level rise and maintain the existing 135-foot vertical clearance, MassDOT proposes to increase the elevation of the bridges by approximately three feet above MHW, for a proposed clearance of 138 feet above MHW. The final bridge height would be confirmed in coordination with the USACE and the United States Coast Guard (USCG).

Attachment 1, Sections 3 through 9 provide assessments of preliminary impacts based on conceptual/ Preliminary design. The DEIR will provide detailed evaluations of Program impacts.

Describe the on-site project alternatives (and alternative off-site locations, if applicable), considered by the proponent, including at least one feasible alternative that is allowed under current zoning, and the reasons(s) that they were not selected as the preferred alternative:

The Program draws from prior studies, including the USACE's March 2020 Cape Cod Canal Highway Bridges Major Rehabilitation Evaluation Report (MRER) and the MassDOT Office of Transportation Planning (OTP) October 2019 Cape Cod Canal Transportation Study, for addressing the deteriorating performance of the aging Bourne and Sagamore Highway Bridges and the multimodal transportation deficiencies of the surrounding approach roadway networks.

Attachment 4, the Alternatives Analysis Report for the Cape Cod Bridges Program, presents the results of two major development phases of a multi-agency examination of the best means to address the functionally obsolete Bourne and Sagamore highway bridges and their operationally deficient highway approach networks. The following provides a summary of the multiple alternatives analyses.

USACE Major Rehabilitation Evaluation Report/Environmental Assessment - Cape Cod Canal Highway Bridges  
In March 2020, the USACE completed a multi-year Major Rehabilitation Evaluation (MRE) of the Bourne and Sagamore Highway Bridges to determine whether major rehabilitation or replacement of either or both bridges would provide the most cost effective, safe, efficient, and reliable means of providing long-term vehicular access across Cape Cod Canal. The study resulted in publication of the MRE Report (MRER), which evaluated the risk and reliability of the Bourne and Sagamore bridges, as well as the economic impacts and benefits of major rehabilitation and several bridge replacement alternatives versus continuing to repair the bridges as needed (Base Condition). As part of this MRER evaluation process, USACE completed an Environmental Assessment (EA) pursuant to the requirements of the National Environmental Policy Act (NEPA) to examine potential impacts associated with the Base Condition, Major Rehabilitation, and Bridge Replacement, as well as other alternatives. MassDOT and FHWA participated as cooperating agencies in the development of the MRER/EA.

Based on a detailed evaluation of costs and benefits of all feasible alternatives, the MRER/EA determined that replacement of the existing bridges with new bridges built to modern-day highway design standards provides the best long-term investment for providing safe and reliable vehicular access across the Cape Cod Canal. The recommended plan (Preferred Alternative) as identified through the USACE's MRER/EA process is replacement of both the Bourne and Sagamore highway bridges with new adjacent bridges, each providing four through traffic lanes (two lanes in each direction), and two auxiliary (acceleration/deceleration) lanes,

plus separate non-vehicular pedestrian and bicycle lanes in accordance with modern highway standards.

After an extended public comment period, the USACE and Assistant Secretary of the Army for Civil Works officially announced their decision to replace the current Sagamore and Bourne bridges with two new bridges built to modern-day standards on April 3, 2020.

#### **MASSDOT Cape Cod Bridges Program Phase 1 and Phase 2 Assessments**

Utilizing the USACE's MRER/EA Preferred Alternative of replacement of both highway bridges with new adjacent bridges (each providing four through traffic lanes and two auxiliary acceleration/deceleration lanes) built to current state and federal highway design standards, MassDOT subsequently identified and evaluated various options for the highway bridges, consisting of bridge main span length and pier location, bridge deck configuration, bridge type, and mainline alignment location, as discussed below:

#### **Main Span Length and Pier Location**

MassDOT evaluated two options for the replacement bridge main span length and pier locations: In-Water and Out-of-Water options. The In-Water Span option includes two approximate main span lengths: 525 feet and 616 feet. The shortest possible span length of 525 feet is dictated by the minimum required horizontal clearance of 500 feet between the edges of the pier footings. The 616-foot span length is the center span length of the existing bridges over Cape Cod Canal, thereby maintaining baseline conditions.

The Out-of-Water Span Option includes two approximate main span lengths: 700 feet and 820 feet. A medium span length of 700 feet would locate the piers within the rip rap slope and above the low tide line. A longer span length of 820 feet would locate the piers entirely on land. Refer to Attachment 4, Section 4 for figures depicting the main span length and pier location options.

MassDOT, in coordination with USACE, identified the Out-of-Water Option, including both medium span and long span variations, as the preferred options for the bridge pier locations based on ease of constructability and future maintenance, removal of fill within the ecologically sensitive Cape Cod Canal, and improved navigational safety through increased horizontal clearance.

#### **Bridge Deck Configuration**

MassDOT evaluated a single deck and a two-deck configuration for each replacement highway bridge mainline. The required roadway width of a single deck for the replacement highway bridges (carrying four 12-foot traffic lanes with auxiliary lanes, shoulders, medians, and pedestrian-bicycle facilities) would be substantial (approximately 129 feet), necessitating a roadway deck with large floor beams. Constructing a single wide deck would add a level of complexity associated with transportability, potentially resulting in larger float-in weights and sizes, larger crane requirements for erection, and interim stability. Additionally, a single deck configuration would have a greater structure depth, requiring a steeper or longer approach on both sides of Cape Cod Canal. Refer to Attachment 4, Section 5 for figures depicting the single and two-deck configurations for each replacement highway bridge mainline.

A two-deck configuration would entail constructing separate deck structures for each replacement highway bridge mainline, consisting of two parallel separate northbound and southbound decks (barrels). A replacement highway bridge with two separate deck structures would have a larger footprint than one single deck structure due to need for providing adequate spacing, approximately 10 feet, between the individual structures. Separate structures would use cost-effective, smaller construction elements with a shallower floor beam depth, which would simplify fabrication and erection. Additionally, separate structures would allow for phased construction of parallel bridge structures, facilitating an earlier decommissioning and demolition of the existing highway bridges than with a single deck. In a two-deck approach, one replacement highway bridge span would be

erected first and carry two-way traffic in a temporary configuration, providing the same number of travel lanes as the existing highway bridge. The next phases would be to demolish the existing bridge and construct the second bridge. The last phases would be to route traffic onto separate northbound and southbound structures and reconfigure the first highway bridge for one-way traffic.

MassDOT identified the two-deck configuration as the preferred option due to benefits in terms of constructability, temporary traffic control and an accelerated schedule for decommissioning and demolition of both existing bridges.

### **Bridge Type**

Considering the most cost-effective bridge types that would meet an approximate 700-foot or 820-foot mainline span length, MassDOT identified the truss bridge, tied-arch bridge, the box girder bridge, and the cable-stayed bridge as the most efficient structure bridge types for the replacement highway bridges. Refer to Attachment 4, Section 6 for schematics of all bridge types considered for the replacement crossings.

Based on a two-phase evaluation of these bridge types relative to Program design criteria, including highway geometrics, construction duration/constructability, wind response and community considerations/context sensitive design, MassDOT determined that the following bridge type will be advanced for further design of the Bourne and Sagamore replacement highway bridges: parallel, twin tied-arch bridge structures supported on Delta frames with an approximate 700-foot mainline span length. MassDOT held public meetings on November 15 and 17, 2022 to present bridge types under consideration for the replacement highway bridges. The Tied-Arch Bridge with Delta Frame on a 700-foot mainline span received the highest public review rating of the bridge types presented.

### **Mainline Alignment Location**

MassDOT evaluated the following mainline alignment location options for each bridge replacement crossing over Cape Cod Canal, as described below:

- Fully Offline – where both barrels of the replacement highway bridge would be located outside the footprint of the existing bridge.
- Partially Offline – where portions of the replacement highway bridge would be located within the footprint of the existing bridge and portions of the replacement highway bridge would be located outside the footprint of the existing bridge.
- Inboard – where the replacement highway bridge would be located on the side of Cape Cod Canal between the existing Bourne Bridge and Sagamore Bridge. For Bourne, the replacement bridge would be east of the existing bridge closer to Cape Cod Bay. For Sagamore, the replacement bridge would be west of the existing bridge closer to Buzzards Bay.
- Outboard – where the replacement highway bridge would be located on the bay side of the existing bridge. For Bourne, the replacement bridge would be west of the existing bridge closer to Buzzards Bay. For Sagamore, the replacement bridge would be east of the existing bridge closer to Cape Cod Bay.
- Split – where the traffic heading on-Cape would be located on one side of the existing bridge and the traffic heading off-Cape would be located on the other side of the existing bridge.

Refer to Attachment 4, Section 8 for figures depicting the mainline alignment location concepts layouts for each replacement crossing over the Cape Cod Canal.

Based on the evaluation of these mainline alignment location options relative to Program design criteria (including traffic operations, connectivity, highway geometrics, traffic safety, constructability/temporary traffic control, multimodal connections, and utility/environmental/right-of-way impacts), MassDOT identified the Fully Offline Inboard option as the most favorable mainline alignment location option for the

replacement highway bridges. In the Fully Offline Inboard option, both barrels of the replacement highway bridge would be located outside the footprint of the existing bridge, approximately 10 feet apart and parallel to each other, on the side of Cape Cod Canal between the existing Bourne Bridge and Sagamore bridges. MassDOT held public meetings on January 24 and 26, 2023 to present the mainline alignment location options under consideration. Based on analysis of the mainline alignment location options presented during these meetings, the Fully Offline Inboard option for the replacement bridges was identified as having the least impacts to residential and commercial properties, while best allowing maintenance of traffic connections during construction.

**Highway Interchange Approach Alternatives**

MassDOT used the Fully Offline Inboard mainline alignment location for the replacement Bourne and Sagamore highway bridges as the basis for identifying and evaluating highway interchange approach alternatives for the four quadrants of the canal crossings within the Program Study Areas, referenced as Bourne North, Bourne South, Sagamore North, and Sagamore South.

Using the alternatives identified in the October 2019 Cape Cod Canal Area Transportation Study as a starting point, MassDOT initially identified and screened 67 highway interchange approach concepts relative to Program design criteria including traffic operations, connectivity, highway geometrics, traffic safety, constructability/temporary traffic control, multimodal connections, and utility/environmental/right-of-way impacts. Based on the screening results of the initial highway interchange approach concepts, MassDOT identified ten highway interchange approach network Build alternatives for the replacement Bourne and Sagamore bridges (including three alternatives for Bourne North, two alternatives for Bourne South, two alternatives for Sagamore North, and three alternatives for Sagamore South) to be advanced for further evaluation. The conceptual layouts for the ten interchange approach alternatives that were advanced for further evaluation are provided in Attachment 4, Sections 9.3.1, 9.4.1, 9.5.1, and 9.6.1. MassDOT is in the process of evaluating these highway interchange approach alternatives to identify preferred pairings for each replacement bridge crossing, which will be presented in the DEIR.

Summarize the mitigation measures proposed to offset the impacts of the preferred alternative:  
**Mitigation measures will be identified upon advancement of alternatives analysis and presented in the DEIR.**

If the project is proposed to be constructed in phases, please describe each phase:  
**Construction phasing for Program elements will be identified in the DEIR.**

**AREAS OF CRITICAL ENVIRONMENTAL CONCERN:**

Is the project within or adjacent to an Area of Critical Environmental Concern?

- Yes (Specify \_\_\_\_\_)  
 No

**The Sagamore Program Study Area includes portions of the Herring River Watershed ACEC, as shown in Attachment 1, Figure 3-7.**

if yes, does the ACEC have an approved Resource Management Plan? \_\_\_ Yes X No;  
If yes, describe how the project complies with this plan.

Will there be stormwater runoff or discharge to the designated ACEC? \_\_\_ Yes X No;  
If yes, describe and assess the potential impacts of such stormwater runoff/discharge to the designated ACEC.

**RARE SPECIES:**

Does the project site include Estimated and/or Priority Habitat of State-Listed Rare Species? (see [http://www.mass.gov/dfwele/dfw/nhesp/regulatory\\_review/priority\\_habitat/priority\\_habitat\\_home.htm](http://www.mass.gov/dfwele/dfw/nhesp/regulatory_review/priority_habitat/priority_habitat_home.htm))

- Yes  No

**As shown on Attachment 1, Figure 4-1, the Bourne Program Study Area is mapped within NHESP Estimated Habitat of Rare Wildlife (EH 400) and NHESP Priority Habitat of Rare Species (PH 455) east of Route 28, south of the Bourne Rotary.**

As shown on Attachment 1, Figure 4-2, the Sagamore Program Study Area is mapped within NHESP Estimated Habitat of Rare Wildlife (EH 399 and 400) and NHESP Priority Habitat of Rare Species (PH 454 and 455) west and east of Route 6 (Mid Cape Highway) south of the Cape Cod Canal.

**HISTORICAL /ARCHAEOLOGICAL RESOURCES:**

Does the project site include any structure, site or district listed in the State Register of Historic Place or the inventory of Historic and Archaeological Assets of the Commonwealth?

Yes No

The Program Study Areas include the Bourne Bridge, the Sagamore Bridge, the Cape Cod Canal Historic District, as well as other resources that are listed in the State Register of Historic Places and the Inventory of Historic and Archaeological Assets of the Commonwealth. Attachment 1, Section 7 provides additional information.

If yes, does the project involve any demolition or destruction of any listed or inventoried historic or archaeological resources? Yes ( ) No

The Program involves the demolition of the Sagamore Bridge (MHC ID: BOU.918) and the Bourne Bridge (MHC ID: BOU.919), which are listed on the Inventory of Historic and Archaeological Assets of the Commonwealth.

**WATER RESOURCES:**

Is there an Outstanding Resource Water (ORW) on or within a half-mile radius of the project site?  Yes \_\_\_ No; if yes, identify the ORW and its location.

A NHESP Certified Vernal Pool (CVP), CVP #555, is located adjacent to the northeast corner of the Sagamore Program Study Area. Attachment 1, Section 5 provides information about the location of the CVP #555 relative to the Program Study Areas.

Are there any impaired water bodies on or within a half-mile radius of the project site?  Yes \_\_\_ No; if yes, identify the water body and pollutant(s) causing the impairment:

Impaired waterbodies exist within and near the Program Study Areas. The Cape Cod Canal (Segment ID: MA95-14) within the Program Study Areas and Back River (Segment ID: MA95-47) within the Bourne Back River and Headwaters ACEC (outside the Program Study Areas) are classified as Category 4a waters, indicating that the water body is impaired, but requisite total daily maximum load is completed. Queen Sewell Pond (Segment ID: MA95180), located north of Bourne Bridge and outside the Program Study Areas, is classified as a Category 5 water, identified as impaired waters requiring a total daily maximum load, for harmful algal blooms on the Massachusetts Year 2016 Integrated List of Waters. South of Cape Cod Canal and outside the Program Study Areas in Sandwich, the Shawme Lake (Segment ID: MA96288 and MA96326) is classified as a Category 5 water for nutrient/eutrophication biological indicators.

Is the project within a medium or high stress basin, as established by the Massachusetts Water Resources Commission? \_\_\_ Yes  No

Cape Cod was not included in the analysis of the Commission for stressed basins in Massachusetts.

**STORMWATER MANAGEMENT:**

Generally describe the project's stormwater impacts and measures that the project will take to comply with the standards found in MassDEP's Stormwater Management Regulations:

The Cape Cod Bridges Program will largely be considered "redevelopment" according to MassDEP's Stormwater Management Standards. As such, the Program will be required to meet stormwater standards to the maximum extent practicable while improving upon existing conditions. Any areas determined to be new development will also be treated per MassDEP Stormwater Standards accordingly. Proposed stormwater improvements include, where applicable, providing drainage systems to the new replacement highway bridges and roadways with connections to the existing system, and retrofitting the existing closed



drainage system by providing new deep sump catch basins. Based on preliminary design, no new stormwater discharges are proposed. The DEIR will include stormwater management updates. Green infrastructure and low impact development (LID) items, including best management practices (BMPs) will be used in the design where space permits to provide water quality treatment measures.

**MASSACHUSETTS CONTINGENCY PLAN:**

Has the project site been, or is it currently being, regulated under M.G.L.c.21E or the Massachusetts Contingency Plan? Yes \_\_\_ No **X**; if yes, please describe the current status of the site (including Release Tracking Number (RTN), cleanup phase, and Response Action Outcome classification)

Is there an Activity and Use Limitation (AUL) on any portion of the project site? Yes \_\_\_ No **X**; if yes, describe which portion of the site and how the project will be consistent with the AUL:

Are you aware of any Reportable Conditions at the property that have not yet been assigned an RTN? Yes \_\_\_ No **X**; if yes, please describe:

**SOLID AND HAZARDOUS WASTE:**

If the project will generate solid waste during demolition or construction, describe alternatives considered for re-use, recycling, and disposal of, e.g., asphalt, brick, concrete, gypsum, metal, wood:

**Solid waste will be generated during the demolition of the existing Bourne and Sagamore highway bridges. The existing highway bridge decks are steel grids filled with five inches of concrete and topped with a two-inch bituminous concrete surface. Channel piers are pairs of hollow concrete columns sitting on footing pedestals in the canal. It is anticipated that the steel will be recycled. MassDOT will dispose of solid waste in accordance with the Solid Waste Management Regulations (310 CMR 19) and other applicable MassDEP policies and guidance. The contractor will develop a Construction and Demolition Waste Management Plan (CDWMP) prior to the start of construction and demolition activities. Lead paint, dating to the 1935 construction of the bridge, likely exists on the bridges. Prior to demolition, materials will be tested for the presence of lead paint. MassDOT will conduct hazardous waste management in accordance with 310 CMR 30.00 and 310 CMR 40.00.**

Will your project disturb asbestos containing materials? Yes \_\_\_ No **X**; if yes, please consult state asbestos requirements at <http://mass.gov/MassDEP/air/asbhom01.htm>

Describe anti-idling and other measures to limit emissions from construction equipment:

**MassDOT will implement measures to limit emissions from construction equipment. MassDOT requires that contractors install emissions control devices in all off-road vehicles. The Revised Diesel Retrofit specification states that emission control standards must be met, or technology must be used for non-road, diesel powered construction equipment exceeding 50 horsepower on MassDOT job sites. MassDOT is a participant in the MassCleanDiesel Program established by MassDEP. As such, the contractor will be required to certify that all contractor and sub-contractor diesel-powered non-road construction equipment and vehicles greater than 50 brake horsepower utilize emission control devices, as specified by the MassDOT Standard Specifications Subsection 7.02 Pollution Prevention. Additionally, the contractor will be required to install on-site anti-idling signage at loading and drop-off/pick up areas to prohibit trucks from engine idling for more than five minutes in compliance with Massachusetts General Law (MGL) Chapter 90, Section 16A and MassDEP anti-idling regulations (310 CMR 7.11(1)(b)).**

**DESIGNATED WILD AND SCENIC RIVER:**

Is this project site located wholly or partially within a defined river corridor of a federally designated Wild and Scenic River or a state designated Scenic River? Yes \_\_\_ No **X**; if yes, specify name of river and designation:

If yes, does the project have the potential to impact any of the "outstandingly remarkable"

resources of a federally Wild and Scenic River or the stated purpose of a state designated Scenic River?  
Yes \_\_\_ No \_\_\_ ; if yes, specify name of river and designation: \_\_\_\_\_;  
if yes, will the project will result in any impacts to any of the designated “outstandingly remarkable”  
resources of the Wild and Scenic River or the stated purposes of a Scenic River.  
Yes \_\_\_ No \_\_\_ ;  
if yes, describe the potential impacts to one or more of the “outstandingly remarkable” resources or  
stated purposes and mitigation measures proposed.

## **ATTACHMENTS:**

1. List of all attachments to this document. **A list of attachments is provided in the Table of Contents.**
2. U.S.G.S. map (good quality color copy, 8-½ x 11 inches or larger, at a scale of 1:24,000) indicating the project location and boundaries. **A USGS Project Location Map is provided as Figure 1-1 in Attachment 1, Program Narrative.**
- 3.. Plan, at an appropriate scale, of existing conditions on the project site and its immediate environs, showing all known structures, roadways and parking lots, railroad rights-of-way, wetlands and water bodies, wooded areas, farmland, steep slopes, public open spaces, and major utilities. **Figures of existing conditions are included in Attachment 1 within applicable sections.**
- 4 Plan, at an appropriate scale, depicting environmental constraints on or adjacent to the project site such as Priority and/or Estimated Habitat of state-listed rare species, Areas of Critical Environmental Concern, Chapter 91 jurisdictional areas, Article 97 lands, wetland resource area delineations, water supply protection areas, and historic resources and/or districts. **Figures of environmental constraints are included in Attachment 1 within applicable sections.**
5. Plan, at an appropriate scale, of proposed conditions upon completion of project (if construction of the project is proposed to be phased, there should be a site plan showing conditions upon the completion of each phase). **Attachment 1, Section 2 includes schematics of ten Bourne crossing and Sagamore crossing highway interchange approach alternatives. The DEIR will identify the highway interchange approach Preferred Alternative (interchange pairing) for each crossing and will include plans of proposed conditions.**
6. List of all agencies and persons to whom the proponent circulated the ENF, in accordance with 301 CMR 11.16(2). **Attachment 2 provides the ENF Distribution List.**
7. List of municipal and federal permits and reviews required by the project, as applicable. **Attachment 3 provides a list of anticipated approvals and permits.**
8. Printout of output report from RMA Climate Resilience Design Standards Tool, available [here](#). **Attachment 8 provides the RMA Climate Resilience Design Standards Reports for the Bourne and Sagamore replacement bridges.**
9. Printout from the EEA [EJ Maps Viewer](#) showing the project location relative to Environmental Justice (EJ) Populations located in whole or in part within a 1-mile and 5-mile radius of the project site. **Figure 9-1 in Attachment 1, Section 9 shows the EJ populations within one mile and five miles of the Program Study Areas.**

**LAND SECTION – all proponents must fill out this section**

**I. Thresholds / Permits**

A. Does the project meet or exceed any review thresholds related to **land** (see 301 CMR 11.03(1))  
 Yes \_\_\_ No; if yes, specify each threshold:

**301 CMR 11.03(1)(a)1. Direct alteration of 50 or more acres of land.**

**301 CMR 11.03(1)(a)2. Creation of ten or more acres of impervious area.**

**II. Impacts and Permits**

A. Describe, in acres, the current and proposed character of the project site, as follows:

**The table below presents the approximate maximum impacts associated with two sets of paired interchange approach alternatives (Bourne North/South and Sagamore North/South) for the total combined Program Study Area. Tables 3-1 through 3-4 in Attachment 1, Section 3 show preliminary estimated acres of land alteration due to the specific highway interchange approach alternatives in each Program Study Area.**

	<u>Existing</u>	<u>Change</u>	<u>Total</u>
Footprint of buildings	<u>--</u>	<u>--</u>	<u>--</u>
Internal roadways	<u>74.5</u>	<u>+27.3</u>	<u>101.8</u>
Parking and other paved areas	<u>62.3</u>	<u>+1.8</u>	<u>64.1</u>
Other altered areas	<u>--</u>	<u>+139.7</u>	<u>139.7</u>
Undeveloped areas	<u>699</u>	<u>-168.8</u>	<u>530.2</u>
<b>Total: Project Site Acreage</b>	<u>835.8</u>		<u>835.8</u>

B. Has any part of the project site been in active agricultural use in the last five years?  
 \_\_\_ Yes  No; if yes, how many acres of land in agricultural use (with prime state or locally important agricultural soils) will be converted to nonagricultural use?

C. Is any part of the project site currently or proposed to be in active forestry use?  
 \_\_\_ Yes  No; if yes, please describe current and proposed forestry activities and indicate whether any part of the site is the subject of a forest management plan approved by the Department of Conservation and Recreation:

D. Does any part of the project involve conversion of land held for natural resources purposes in accordance with Article 97 of the Amendments to the Constitution of the Commonwealth to any purpose not in accordance with Article 97? \_\_\_ Yes  No; if yes, describe:

E. Is any part of the project site currently subject to a conservation restriction, preservation restriction, agricultural preservation restriction or watershed preservation restriction? \_\_\_ Yes \_\_\_ No; if yes, does the project involve the release or modification of such restriction? \_\_\_ Yes  No; if yes, describe:

F. Does the project require approval of a new urban redevelopment project or a fundamental change in an existing urban redevelopment project under M.G.L.c.121A? \_\_\_ Yes  No; if yes, describe:

G. Does the project require approval of a new urban renewal plan or a major modification of an existing urban renewal plan under M.G.L.c.121B? Yes \_\_\_ No ; if yes, describe:

### III. Consistency

A. Identify the current municipal comprehensive land use plan  
Title: **Town of Bourne Local Comprehensive Plan** Date: **Revised 2019**

- B. Describe the project's consistency with that plan with regard to:
- 1) economic development
  - 2) adequacy of infrastructure
  - 3) open space impacts
  - 4) compatibility with adjacent land uses

**The Program is consistent with the Town of Bourne Local Comprehensive Plan (LCP) regarding economic development, transportation needs, open space, and adjacent land uses. The replacement highway bridges, and their interchange approaches would include shared use pedestrian and bicycle paths that would provide connections on both sides of the canal to the local roadway network in the Town of Bourne, which is consistent with an economic policy of the Town of Bourne to: *"Recognize the economic benefit to Bourne generated by recreational activities such as...recreational trails..."* The Program is consistent with the infrastructure policies of the LCP as expressed through its transportation goals, coastal resiliency goals, and capital facilities and infrastructure goals. Included in the Program's Purpose and Need statement is the need to address the increasing maintenance needs and functional obsolescence of the aging Cape Cod Canal highway bridges. Additionally, the Program would include upgrading the roadway network approaches to the highway bridges. The Program is consistent with the open space policy of the LCP to enhance public access to existing conservation land and to establish green corridors and/or connections, as evidenced through the incorporation of a shared-use path for each highway bridge that includes connections to the local roadway network. The Program would minimize impacts to open space, including the USACE-leased property on the canal, to the greatest extent practicable. With in-kind highway bridge replacement structures updated to comply with federal and state highway and design safety standards, the Program would not substantially alter existing conditions relative to adjacent land uses. To the greatest extent practicable, MassDOT would minimize the Program's construction and operational impacts upon adjacent properties. Attachment 1, Section 3.5.1 provides further details regarding Program consistency with the LCP.**

C. Identify the current Regional Policy Plan of the applicable Regional Planning Agency (RPA)  
RPA: **Cape Cod Commission**

Title: **Cape Cod Regional Policy Plan** Date: **February 22, 2019**

- D. Describe the project's consistency with that plan with regard to:
- 1) economic development
  - 2) adequacy of infrastructure
  - 3) open space impacts

**The Program is consistent with the Cape Cod Regional Policy Plan (RPP) regarding economic development, adequacy of infrastructure, and open space impacts. The Program is consistent with the long-term economic goals of the RPP, including the need to promote long-term sustainability and resiliency. MassDOT is designing the replacement highway bridges to maximize sustainability and resiliency. By providing two highway structures at each crossing, MassDOT would be able to completely close one structure in the event of a compromising event, while still accommodating traffic operations on the second structure. Additionally, by incorporating additional height to accommodate sea level rise and by**

locating the bridge piers outside the waterway, MassDOT would provide for safer and reliable navigation at the bridge sites while improving the resiliency of the structures. The Program is consistent with the open space and related community design and cultural heritage goals of the Cape Cod RPP. MassDOT is designing the replacement bridges to minimize impacts to adjacent land uses, including operational and construction impacts to maritime uses. Additionally, the replacement highways each would include a pedestrian/bicyclist shared use path, which would connect to existing rail trails on both sides of the canal. To address RPP's cultural heritage goal, the Cape Cod Bridges Program would include a Memorandum of Agreement to incorporate measures to mitigate for the demolition of the historic bridges. Attachment 1, Section 3.5.2 provides further details regarding Program consistency with the RPP.

## **RARE SPECIES SECTION**

### **I. Thresholds / Permits**

A. Will the project meet or exceed any review thresholds related to **rare species or habitat** (see 301 CMR 11.03(2))?  Yes  No; if yes, specify, in quantitative terms:

**TBD. Pending further design and evaluation of the highway interchange approach alternatives, the Program could meet or exceed review thresholds related to rare species or habitat, which will be reported in the DEIR.**

B. Does the project require any state permits related to **rare species or habitat**?  Yes  No

**TBD. The Program could require a MESA Conservation and Management Permit from MA Division of Fisheries & Wildlife. Attachment 1, Section 4 provides additional information.**

C. Does the project site fall within mapped rare species habitat (Priority or Estimated Habitat?) in the current Massachusetts Natural Heritage Atlas (attach relevant page)?  Yes  No.

**Attachment 6.1 provides the relevant page of the Massachusetts Natural Heritage Atlas. Portions of the Program Study Areas are within mapped rare species habitat as shown in Attachment 1, Figures 4-1 and 4-2.**

D. If you answered "No" to all questions A, B and C, proceed to the **Wetlands, Waterways, and Tidelands Section**. If you answered "Yes" to either question A or question B, fill out the remainder of the Rare Species section below.

### **II. Impacts and Permits**

A. Does the project site fall within Priority or Estimated Habitat in the current Massachusetts Natural Heritage Atlas (attach relevant page)?  Yes  No. If yes,

1. Have you consulted with the Division of Fisheries and Wildlife Natural Heritage and Endangered Species Program (NHESP)?  Yes  No; if yes, have you received a determination as to whether the project will result in the "take" of a rare species?  Yes  No; if yes, attach the letter of determination to this submission.

2. Will the project "take" an endangered, threatened, and/or species of special concern in accordance with M.G.L. c.131A (see also 321 CMR 10.04)?  Yes  No; if yes, provide a summary of proposed measures to minimize and mitigate rare species impacts  
**Coordination with NHESP indicates that the Program could result in a "take" of species protected under MESA. Attachment 1, Section 4 provides additional information.**

3. Which rare species are known to occur within the Priority or Estimated Habitat?  
**Early coordination with NHESP identified 13 protected rare species within the Program Study Areas.**

4. Has the site been surveyed for rare species in accordance with the Massachusetts Endangered Species Act?  Yes \_\_\_ No

**In Summer 2020, MassDOT conducted a Rare, Threatened, and Endangered Species (RTE) Habitat Assessment within and adjacent to the Program Study Areas. The assessment utilized NHESP survey methodology to identify and characterize the existing habitats that may be suitable for protected species. Refer to Attachment 1, Section 4 for additional information.**

4. If your project is within Estimated Habitat, have you filed a Notice of Intent or received an Order of Conditions for this project? \_\_\_ Yes  No; if yes, did you send a copy of the Notice of Intent to the Natural Heritage and Endangered Species Program, in accordance with the Wetlands Protection Act regulations? \_\_\_ Yes \_\_\_ No

B. Will the project "take" an endangered, threatened, and/or species of special concern in accordance with M.G.L. c.131A (see also 321 CMR 10.04)? \_\_\_ Yes \_\_\_ No; if yes, provide a summary of proposed measures to minimize and mitigate impacts to significant habitat:

**Coordination with NHESP indicates that the Program could result in a "take" of species protected under MESA. Further coordination with NHESP will be required through project development to identify effects to MESA-protected species. Attachment 1, Section 4 provides additional information. Impacts to protected species and habitat, as well as measures to avoid, minimize and mitigate impacts, will be determined as design advances, and reported in the DEIR.**

## **WETLANDS, WATERWAYS, AND TIDELANDS SECTION**

### **I. Thresholds / Permits**

A. Will the project meet or exceed any review thresholds related to **wetlands, waterways, and tidelands** (see 301 CMR 11.03(3))? \_\_\_ Yes  No; if yes, specify, in quantitative terms:

B. Does the project require any state permits (or a local Order of Conditions) related to **wetlands, waterways, or tidelands**?  Yes \_\_\_ No; if yes, specify which permit:

**The Program will require an Order of Conditions from the Bourne Conservation Commission, in addition to 401 Water Quality Certification and Chapter 91 Waterways Licenses from MassDEP.**

C. If you answered "No" to both questions A and B, proceed to the **Water Supply Section**. If you answered "Yes" to either question A or question B, fill out the remainder of the Wetlands, Waterways, and Tidelands Section below.

### **II. Wetlands Impacts and Permits**

A. Does the project require a new or amended Order of Conditions under the Wetlands Protection Act (M.G.L. c.131A)?  Yes \_\_\_ No; if yes, has a Notice of Intent been filed? \_\_\_ Yes  No; if yes, list the date and MassDEP file number: \_\_\_\_\_; if yes, has a local Order of Conditions been issued? \_\_\_ Yes \_\_\_ No; Was the Order of Conditions appealed? \_\_\_ Yes \_\_\_ No. Will the project require a Variance from the Wetlands regulations? \_\_\_ Yes \_\_\_ No.

B. Describe any proposed permanent or temporary impacts to wetland resource areas located on the project site:

**The demolition of the Bourne and Sagamore Bridges will involve temporary impacts to Land under the Ocean of the Cape Cod Canal due to removal of existing bridge piers. Based on conceptual design, bridge replacements at both crossings would impact Land Subject to Coastal Storm Flowage (LSCSF), due to the installation of bridge piers within the rip rap portions of Cape Cod Canal. It is anticipated that the Bourne crossing interchange approach alternatives would**

result in impacts to Isolated Land Subject to Flooding (ILSF). Tables 5-1 through 5-3 in Attachment 1, Section 5 identify potential impacts to wetland resources based on conceptual/preliminary design. Permanent or temporary impacts to wetland resource areas will be determined as design advances and reported in the DEIR.

C. Estimate the extent and type of impact that the project will have on wetland resources, and indicate whether the impacts are temporary or permanent:

Tables 5-1 through 5-3 in Attachment 1, Section 5 provide estimated impacts to wetland resources due to the fully offline mainline alignment and interchange approach alternatives for each bridge crossing. Based on additional design and determination of the preferred interchange approach alternatives, impacts will be refined and reported in the DEIR.

<u>Coastal Wetlands</u>	<u>Area (square feet) or Length (linear feet)</u>	<u>Temporary or Permanent Impact?</u>
Land Under the Ocean	<b>TBD</b>	<b>Temporary</b>
Designated Port Areas	<b>N/A</b>	<b>N/A</b>
Coastal Beaches	<b>N/A</b>	<b>N/A</b>
Coastal Dunes	<b>N/A</b>	<b>N/A</b>
Barrier Beaches	<b>N/A</b>	<b>N/A</b>
Coastal Banks	<b>N/A</b>	<b>N/A</b>
Rocky Intertidal Shores	<b>N/A</b>	<b>N/A</b>
Salt Marshes	<b>N/A</b>	<b>N/A</b>
Land Under Salt Ponds	<b>N/A</b>	<b>N/A</b>
Land Containing Shellfish	<b>N/A</b>	<b>N/A</b>
Fish Runs	<b>N/A</b>	<b>N/A</b>
Land Subject to Coastal Storm Flowage	<b>Up to 155,000 cubic feet</b>	<b>Permanent</b>
<u>Inland Wetlands</u>		
Bank (lf)	<b>N/A</b>	<b>N/A</b>
Bordering Vegetated Wetlands	<b>TBD</b>	<b>Permanent and Temporary</b>
Isolated Vegetated Wetlands	<b>N/A</b>	<b>N/A</b>
Land under Water	<b>N/A</b>	<b>N/A</b>
Isolated Land Subject to Flooding	<b>Up to 5,200 sf</b>	<b>Permanent and Temporary</b>
Bordering Land Subject to Flooding	<b>N/A</b>	<b>N/A</b>
Riverfront Area	<b>N/A</b>	<b>N/A</b>

D. Is any part of the project:

1. proposed as a **limited project**? \_\_\_ Yes **X** No; if yes, what is the area (in sf)? \_\_\_
2. the construction or alteration of a **dam**? \_\_\_ Yes **X** No; if yes, describe:
3. fill or structure in a **velocity zone** or **regulatory floodway**? \_\_\_ Yes **X** No
4. dredging or disposal of dredged material? **X** Yes \_\_\_ No; if yes, describe the volume of dredged material and the proposed disposal site: **TBD as design is advanced**
5. a discharge to an **Outstanding Resource Water (ORW)** or an **Area of Critical Environmental Concern (ACEC)**? \_\_\_ Yes **X** No
6. subject to a wetlands restriction order? \_\_\_ Yes **X** No; if yes, identify the area (in sf):
7. located in buffer zones? **X** Yes \_\_\_ No; if yes, how much (in sf) **TBD as design is advanced**

**advanced**

E. Will the project:

1. be subject to a local wetlands ordinance or bylaw? \_\_\_ Yes **X** No
2. alter any federally-protected wetlands not regulated under state law? **X** Yes \_\_\_ No; if



yes, what is the area (sf)?

**MassDOT has identified potential impacts to federally protected wetland resources that do not meet the regulatory criteria for WPA-jurisdiction associated with the two Bourne South interchange approach alternatives, the Diamond Interchange and the Single-Point Interchange alternatives. It is anticipated that each alternative would independently result in approximately 3,700 sf of impacts to these federal jurisdictional resources areas that do not meet the criteria for WPA-jurisdiction. Refer to Attachment 1, Section 5.2 for additional information.**

**III. Waterways and Tidelands Impacts and Permits**

A. Does the project site contain waterways or tidelands (including filled former tidelands) that are subject to the Waterways Act, M.G.L.c.91?  Yes \_\_\_ No; if yes, is there a current Chapter 91 License or Permit affecting the project site? \_\_\_ Yes  No; if yes, list the date and license or permit number and provide a copy of the historic map used to determine extent of filled tidelands:

D. Does the project require a new or modified license or permit under M.G.L.c.91?  Yes \_\_\_ No; if yes, how many acres of the project site subject to M.G.L.c.91 will be for non-water-dependent use? Current \_\_\_ Change \_\_\_ Total \_\_\_  
If yes, how many square feet of solid fill or pile-supported structures (in sf)?

**The Program will require new water-dependent licenses under M.G.L.c.91 for replacement of the Bourne and Sagamore highway bridges over the Cape Cod Canal. No Program component will be for non-water dependent use.**

C. For non-water-dependent use projects, indicate the following:

Area of filled tidelands on the site: \_\_\_\_\_

Area of filled tidelands covered by buildings: \_\_\_\_\_

For portions of site on filled tidelands, list ground floor uses and area of each use:

\_\_\_\_\_ Does the project include new non-water-dependent uses located over flowed tidelands?

Yes \_\_\_ No \_\_\_

Height of building on filled tidelands \_\_\_\_\_

Also show the following on a site plan: Mean High Water, Mean Low Water, Water-dependent Use Zone, location of uses within buildings on tidelands, and interior and exterior areas and facilities dedicated for public use, and historic high and historic low water marks.

D. Is the project located on landlocked tidelands? \_\_\_ Yes  No; if yes, describe the project's impact on the public's right to access, use and enjoy jurisdictional tidelands and describe measures the project will implement to avoid, minimize or mitigate any adverse impact:

E. Is the project located in an area where low groundwater levels have been identified by a municipality or by a state or federal agency as a threat to building foundations? \_\_\_ Yes  No; if yes, describe the project's impact on groundwater levels and describe measures the project will implement to avoid, minimize or mitigate any adverse impact:

F. Is the project non-water-dependent **and** located on landlocked tidelands **or** waterways or tidelands subject to the Waterways Act **and** subject to a mandatory EIR? \_\_\_ Yes  No; (NOTE: If yes, then the project will be subject to Public Benefit Review and Determination.)

G. Does the project include dredging?  Yes \_\_\_ No; if yes, answer the following questions:  
What type of dredging? Improvement  Maintenance \_\_\_ Both \_\_\_  
What is the proposed dredge volume, in cubic yards (cy) **TBD**

What is the proposed dredge footprint **TBD** length (ft) **TBD** width (ft) **TBD** depth (ft);  
Will dredging impact the following resource areas?

Intertidal Yes  No ; if yes, **TBD** sq ft

Outstanding Resource Waters Yes  No ; if yes,  sq ft

Other resource area (i.e. shellfish beds, eel grass beds) Yes  No ; if yes  sq ft

If yes to any of the above, have you evaluated appropriate and practicable steps to: 1) avoidance; 2) if avoidance is not possible, minimization; 3) if either avoidance or minimize is not possible, mitigation?

**Minimization measures will be evaluated and determined as the design advances.**

If no to any of the above, what information or documentation was used to support this determination?

Provide a comprehensive analysis of practicable alternatives for improvement dredging in accordance with 314 CMR 9.07(1)(b). Physical and chemical data of the sediment shall be included in the comprehensive analysis.

Sediment Characterization

Existing gradation analysis results?  Yes  No; if yes, provide results.

Existing chemical results for parameters listed in 314 CMR 9.07(2)(b)6?  Yes  No; if yes, provide results.

Do you have sufficient information to evaluate feasibility of the following management options for dredged sediment? If yes, check the appropriate option.

Beach Nourishment

Unconfined Ocean Disposal

Confined Disposal:

Confined Aquatic Disposal (CAD)

Confined Disposal Facility (CDF)

Landfill Reuse in accordance with COMM-97-001

Shoreline Placement

Upland Material Reuse

In-State landfill disposal

Out-of-state landfill disposal

(NOTE: This information is required for a 401 Water Quality Certification.)

#### IV. Consistency:

- A. Does the project have effects on the coastal resources or uses, and/or is the project located within the Coastal Zone?  Yes  No; if yes, describe these effects and the projects consistency with the policies of the Office of Coastal Zone Management:

**The Bourne and Sagamore Program Study Areas, as well as all of Cape Cod, are included in the Massachusetts coastal zone boundary. Attachment 1, Section 5.4 describes the Program's consistency with Coastal Zone Management policies.**

- B. Is the project located within an area subject to a Municipal Harbor Plan?  Yes  No; if yes, identify the Municipal Harbor Plan and describe the project's consistency with that plan:

## WATER SUPPLY SECTION

### I. Thresholds / Permits

- A. Will the project meet or exceed any review thresholds related to **water supply** (see 301 CMR 11.03(4))?  Yes  No; if yes, specify, in quantitative terms:

- B. Does the project require any state permits related to **water supply**?  Yes  No; if yes, specify which permit:

C. If you answered "No" to both questions A and B, proceed to the **Wastewater Section**. If you answered "Yes" to either question A or question B, fill out the remainder of the Water Supply Section below.

**II. Impacts and Permits**

A. Describe, in gallons per day (gpd), the volume and source of water use for existing and proposed activities at the project site:

	<u>Existing</u>	<u>Change</u>	<u>Total</u>
Municipal or regional water supply	_____	_____	_____
Withdrawal from groundwater	_____	_____	_____
Withdrawal from surface water	_____	_____	_____
Interbasin transfer	_____	_____	_____

*(NOTE: Interbasin Transfer approval will be required if the basin and community where the proposed water supply source is located is different from the basin and community where the wastewater from the source will be discharged.)*

B. If the source is a municipal or regional supply, has the municipality or region indicated that there is adequate capacity in the system to accommodate the project?  Yes  No

C. If the project involves a new or expanded withdrawal from a groundwater or surface water source, has a pumping test been conducted?  Yes  No; if yes, attach a map of the drilling sites and a summary of the alternatives considered and the results. \_\_\_\_\_

D. What is the currently permitted withdrawal at the proposed water supply source (in gallons per day)? \_\_\_\_\_ Will the project require an increase in that withdrawal?  Yes  No; if yes, then how much of an increase (gpd)? \_\_\_\_\_

E. Does the project site currently contain a water supply well, a drinking water treatment facility, water main, or other water supply facility, or will the project involve construction of a new facility?  Yes  No. If yes, describe existing and proposed water supply facilities at the project site:

	<u>Permitted Flow</u>	<u>Existing Avg Daily Flow</u>	<u>Project Flow</u>	<u>Total</u>
Capacity of water supply well(s) (gpd)	_____	_____	_____	_____
Capacity of water treatment plant (gpd)	_____	_____	_____	_____

F. If the project involves a new interbasin transfer of water, which basins are involved, what is the direction of the transfer, and is the interbasin transfer existing or proposed?

G. Does the project involve:

1. new water service by the Massachusetts Water Resources Authority or other agency of the Commonwealth to a municipality or water district?  Yes  No
2. a Watershed Protection Act variance?  Yes  No; if yes, how many acres of alteration?
3. a non-bridged stream crossing 1,000 or less feet upstream of a public surface drinking water supply for purpose of forest harvesting activities?  Yes  No

**III. Consistency**

Describe the project's consistency with water conservation plans or other plans to enhance water resources, quality, facilities and services:

## WASTEWATER SECTION

### I. Thresholds / Permits

A. Will the project meet or exceed any review thresholds related to **wastewater** (see 301 CMR 11.03(5))? \_\_\_ Yes  No; if yes, specify, in quantitative terms:

B. Does the project require any state permits related to **wastewater**? \_\_\_ Yes  No; if yes, specify which permit:

C. If you answered "No" to both questions A and B, proceed to the **Transportation -- Traffic Generation Section**. If you answered "Yes" to either question A or question B, fill out the remainder of the Wastewater Section below.

### II. Impacts and Permits

A. Describe the volume (in gallons per day) and type of disposal of wastewater generation for existing and proposed activities at the project site (calculate according to 310 CMR 15.00 for septic systems or 314 CMR 7.00 for sewer systems):

	<u>Existing</u>	<u>Change</u>	<u>Total</u>
Discharge of sanitary wastewater	_____	_____	_____
Discharge of industrial wastewater	_____	_____	_____
TOTAL	_____	_____	_____

	<u>Existing</u>	<u>Change</u>	<u>Total</u>
Discharge to groundwater	_____	_____	_____
Discharge to outstanding resource water	_____	_____	_____
Discharge to surface water	_____	_____	_____
Discharge to municipal or regional wastewater facility	_____	_____	_____
TOTAL	_____	_____	_____

B. Is the existing collection system at or near its capacity? \_\_\_ Yes \_\_\_ No; if yes, then describe the measures to be undertaken to accommodate the project's wastewater flows:

C. Is the existing wastewater disposal facility at or near its permitted capacity? \_\_\_ Yes \_\_\_ No; if yes, then describe the measures to be undertaken to accommodate the project's wastewater flows:

D. Does the project site currently contain a wastewater treatment facility, sewer main, or other wastewater disposal facility, or will the project involve construction of a new facility? \_\_\_ Yes \_\_\_ No; if yes, describe as follows:

	<u>Permitted</u>	<u>Existing Avg Daily Flow</u>	<u>Project Flow</u>	<u>Total</u>
Wastewater treatment plant capacity (in gallons per day)	_____	_____	_____	_____

E. If the project requires an interbasin transfer of wastewater, which basins are involved, what is the direction of the transfer, and is the interbasin transfer existing or new?

*(NOTE: Interbasin Transfer approval may be needed if the basin and community where wastewater will be discharged is different from the basin and community where the source of water supply is located.)*

F. Does the project involve new sewer service by the Massachusetts Water Resources Authority (MWRA) or other Agency of the Commonwealth to a municipality or sewer district? \_\_\_ Yes \_\_\_ No

G. Is there an existing facility, or is a new facility proposed at the project site for the storage, treatment, processing, combustion or disposal of sewage sludge, sludge ash, grit, screenings, wastewater reuse (gray water) or other sewage residual materials? \_\_\_ Yes \_\_\_ No; if yes, what is the capacity (tons per day):

	<u>Existing</u>	<u>Change</u>	<u>Total</u>
Storage	_____	_____	_____
Treatment	_____	_____	_____
Processing	_____	_____	_____
Combustion	_____	_____	_____
Disposal	_____	_____	_____

H. Describe the water conservation measures to be undertaken by the project, and other wastewater mitigation, such as infiltration and inflow removal.

**III. Consistency**

- A. Describe measures that the proponent will take to comply with applicable state, regional, and local plans and policies related to wastewater management:
- B. If the project requires a sewer extension permit, is that extension included in a comprehensive wastewater management plan? \_\_\_ Yes \_\_\_ No; if yes, indicate the EEA number for the plan and whether the project site is within a sewer service area recommended or approved in that plan:

**TRANSPORTATION SECTION (TRAFFIC GENERATION)**

**I. Thresholds / Permit**

- A. Will the project meet or exceed any review thresholds related to **traffic generation** (see 301 CMR 11.03(6))? \_\_\_ Yes X No; if yes, specify, in quantitative terms:
- B. Does the project require any state permits related to **state-controlled roadways**? \_\_\_ Yes X No; if yes, specify which permit:
- C. If you answered "No" to both questions A and B, proceed to the **Roadways and Other Transportation Facilities Section**. If you answered "Yes" to either question A or question B, fill out the remainder of the Traffic Generation Section below.

**II. Traffic Impacts and Permits**

A. Describe existing and proposed vehicular traffic generated by activities at the project site:

	<u>Existing</u>	<u>Change</u>	<u>Total</u>
Number of parking spaces	_____	_____	_____
Number of vehicle trips per day	_____	_____	_____
ITE Land Use Code(s):	_____	_____	_____

B. What is the estimated average daily traffic on roadways serving the site?

<u>Roadway</u>	<u>Existing</u>	<u>Change</u>	<u>Total</u>
1. _____	_____	_____	_____
2. _____	_____	_____	_____
3. _____	_____	_____	_____

C. If applicable, describe proposed mitigation measures on state-controlled roadways that the project proponent will implement:

- D. How will the project implement and/or promote the use of transit, pedestrian and bicycle facilities and services to provide access to and from the project site?
- C. Is there a Transportation Management Association (TMA) that provides transportation demand management (TDM) services in the area of the project site? \_\_\_ Yes \_\_\_ No; if yes, describe if and how will the project will participate in the TMA:
- D. Will the project use (or occur in the immediate vicinity of) water, rail, or air transportation facilities? \_\_\_ Yes \_\_\_ No; if yes, generally describe:
- E. If the project will penetrate approach airspace of a nearby airport, has the proponent filed a Massachusetts Aeronautics Commission Airspace Review Form (780 CMR 111.7) and a Notice of Proposed Construction or Alteration with the Federal Aviation Administration (FAA) (CFR Title 14 Part 77.13, forms 7460-1 and 7460-2)?

### III. Consistency

Describe measures that the proponent will take to comply with municipal, regional, state, and federal plans and policies related to traffic, transit, pedestrian and bicycle transportation facilities and services:

## **TRANSPORTATION SECTION (ROADWAYS AND OTHER TRANSPORTATION FACILITIES)**

### I. Thresholds

A. Will the project meet or exceed any review thresholds related to **roadways or other transportation facilities** (see 301 CMR 11.03(6))?  Yes \_\_\_ No; if yes, specify, in quantitative terms:

- **301 CMR 11.03(6)(b)1. b. – widening of an existing roadway by four or more feet for one-half or more miles, excluding widening to add bicycle or pedestrian accommodations.**
- **301 CMR 11.03(6)(b)2. a. – Construction, widening, or maintenance of a roadway or its right-of-way that will alter the bank or terrain located ten more feet from the existing roadway for one-half or more miles.**
- **301 CMR 11.03(6)(b)2. b. – Construction, widening, or maintenance of a roadway or its right-of-way that will cut five or more living public shade trees of 14 or more inches in diameter at breast height.**

B. Does the project require any state permits related to **roadways or other transportation facilities**? \_\_\_ Yes  No; if yes, specify which permit:

C. If you answered "No" to both questions A and B, proceed to the **Energy Section**. If you answered "Yes" to either question A or question B, fill out the remainder of the Roadways Section below.

### II. Transportation Facility Impacts

A. Describe existing and proposed transportation facilities in the immediate vicinity of the project site:

**Discussion of existing transportation facilities within the Program Study Areas is presented in Attachment 1, Section 6. Refer to Attachment 1, Section 2 for discussion of the proposed replacement bridges. Discussion of the proposed transportation facilities in the Program Study Areas will be provided in the DEIR, following the identification of the preferred interchange approach alternatives for each crossing.**

- B. Will the project involve any
- |  |                                 |
|--|---------------------------------|
| 1. Alteration of bank or terrain (in linear feet)? | <b>Up to 54,200 linear feet</b> |
| 2. Cutting of living public shade trees (number)?  | <b>Up to 9</b>                  |
| 3. Elimination of stone wall (in linear feet)?     | <b>No</b>                       |

**III. Consistency** -- Describe the project's consistency with other federal, state, regional, and local plans and policies related to traffic, transit, pedestrian and bicycle transportation facilities and services, including consistency with the applicable regional transportation plan and the Transportation Improvements Plan (TIP), the State Bicycle Plan, and the State Pedestrian Plan:

**The Cape Cod Bridges Program is intended to improve cross-canal mobility and accessibility between Cape Cod and mainland Massachusetts for all road users, including motorists, pedestrians, and bicyclists. Attachment 1, Section 6.5 describes the Program's consistency with state, regional, and local plans and policies related to traffic, transit, pedestrian and bicycle transportation facilities and services.**

## **ENERGY SECTION**

### **I. Thresholds / Permits**

A. Will the project meet or exceed any review thresholds related to **energy** (see 301 CMR 11.03(7))? \_\_\_ Yes  No; if yes, specify, in quantitative terms:

B. Does the project require any state permits related to **energy**? \_\_\_ Yes  No; if yes, specify which permit:

C. If you answered "No" to both questions A and B, proceed to the **Air Quality Section**. If you answered "Yes" to either question A or question B, fill out the remainder of the Energy Section below.

### **II. Impacts and Permits**

A. Describe existing and proposed energy generation and transmission facilities at the project site:

	<u>Existing Change</u>	<u>Total</u>	
Capacity of electric generating facility (megawatts)	_____	_____	_____
Length of fuel line (in miles)	_____	_____	_____
Length of transmission lines (in miles)	_____	_____	_____
Capacity of transmission lines (in kilovolts)	_____	_____	_____

B. If the project involves construction or expansion of an electric generating facility, what are:

1. the facility's current and proposed fuel source(s)?
2. the facility's current and proposed cooling source(s)?

C. If the project involves construction of an electrical transmission line, will it be located on a new, unused, or abandoned right of way? \_\_\_ Yes \_\_\_ No; if yes, please describe:

D. Describe the project's other impacts on energy facilities and services:

### **III. Consistency**

Describe the project's consistency with state, municipal, regional, and federal plans and policies for enhancing energy facilities and services:

## **AIR QUALITY SECTION**

### **I. Thresholds**

A. Will the project meet or exceed any review thresholds related to **air quality** (see 301 CMR 11.03(8))? \_\_\_ Yes  No; if yes, specify, in quantitative terms:

B. Does the project require any state permits related to **air quality**? \_\_\_ Yes  No; if yes, specify which permit:

C. If you answered "No" to both questions A and B, proceed to the **Solid and Hazardous Waste Section**. If you answered "Yes" to either question A or question B, fill out the remainder of the Air Quality Section below.

**II. Impacts and Permits**

A. Does the project involve construction or modification of a major stationary source (see 310 CMR 7.00, Appendix A)? \_\_\_ Yes \_\_\_ No; if yes, describe existing and proposed emissions (in tons per day) of:

	<u>Existing</u>	<u>Change</u>	<u>Total</u>
Particulate matter	_____	_____	_____
Carbon monoxide	_____	_____	_____
Sulfur dioxide	_____	_____	_____
Volatile organic compounds	_____	_____	_____
Oxides of nitrogen	_____	_____	_____
Lead	_____	_____	_____
Any hazardous air pollutant	_____	_____	_____
Carbon dioxide	_____	_____	_____

B. Describe the project's other impacts on air resources and air quality, including noise impacts:

**III. Consistency**

A. Describe the project's consistency with the State Implementation Plan:

C. Describe measures that the proponent will take to comply with other federal, state, regional, and local plans and policies related to air resources and air quality:

**SOLID AND HAZARDOUS WASTE SECTION**

**I. Thresholds / Permits**

A. Will the project meet or exceed any review thresholds related to **solid or hazardous waste** (see 301 CMR 11.03(9))? \_\_\_ Yes \_\_\_ No; if yes, specify, in quantitative terms:

D. Does the project require any state permits related to **solid and hazardous waste**? \_\_\_ Yes  No; if yes, specify which permit:

C. If you answered "No" to both questions A and B, proceed to the **Historical and Archaeological Resources Section**. If you answered "Yes" to either question A or question B, fill out the remainder of the Solid and Hazardous Waste Section below.

**II. Impacts and Permits**

A. Is there any current or proposed facility at the project site for the storage, treatment, processing, combustion or disposal of solid waste? \_\_\_ Yes \_\_\_ No; if yes, what is the volume (in tons per day) of the capacity:

	<u>Existing</u>	<u>Change</u>	<u>Total</u>
Storage	_____	_____	_____
Treatment, processing	_____	_____	_____
Combustion	_____	_____	_____
Disposal	_____	_____	_____



B. Is there any current or proposed facility at the project site for the storage, recycling, treatment or disposal of hazardous waste? \_\_\_ Yes \_\_\_ No; if yes, what is the volume (in tons or gallons per day) of the capacity:

	<u>Existing</u>	<u>Change</u>	<u>Total</u>
Storage	_____	_____	_____
Recycling	_____	_____	_____
Treatment	_____	_____	_____
Disposal	_____	_____	_____

C. If the project will generate solid waste (for example, during demolition or construction), describe alternatives considered for re-use, recycling, and disposal:

D. If the project involves demolition, do any buildings to be demolished contain asbestos?  
 \_\_\_ Yes \_\_\_ No

E. Describe the project's other solid and hazardous waste impacts (including indirect impacts):

**III. Consistency**

Describe measures that the proponent will take to comply with the State Solid Waste Master Plan:

**HISTORICAL AND ARCHAEOLOGICAL RESOURCES SECTION**

**I. Thresholds / Impacts**

A. Have you consulted with the Massachusetts Historical Commission?  Yes \_\_\_ No; if yes, attach correspondence. For project sites involving lands under water, have you consulted with the Massachusetts Board of Underwater Archaeological Resources?  Yes \_\_\_ No; if yes, attach correspondence

**Attachment 7 provides records of previous correspondence with the Massachusetts Historical Commission and the Massachusetts Board of Underwater Archaeological Resources.**

B. Is any part of the project site a historic structure, or a structure within a historic district, in either case listed in the State Register of Historic Places or the Inventory of Historic and Archaeological Assets of the Commonwealth?  Yes \_\_\_ No; if yes, does the project involve the demolition of all or any exterior part of such historic structure?  Yes \_\_\_ No; if yes, please describe:

**The Program proposes demolition of the existing Bourne and Sagamore Bridges, which are listed on the Inventory of Historic and Archaeological Assets of the Commonwealth. MassDOT proposes to replace the Bourne and Sagamore highway bridges with parallel, twin network tied-arch bridge structures in the same general location, but outside the footprint of the existing bridges.**

C. Is any part of the project site an archaeological site listed in the State Register of Historic Places or the Inventory of Historic and Archaeological Assets of the Commonwealth?  Yes \_\_\_ No; if yes, does the project involve the destruction of all or any part of such archaeological site? \_\_\_ Yes  No; if yes, please describe:

D. If you answered "No" to all parts of both questions A, B and C, proceed to the **Attachments and Certifications** Sections. If you answered "Yes" to any part of either question A or question B, fill out the remainder of the Historical and Archaeological Resources Section below.

**II. Impacts**

Describe and assess the project's impacts, direct and indirect, on listed or inventoried historical and archaeological resources:

**Demolition of the existing bridges would cause an adverse effect to the two National Register-**

eligible structures in accordance with Section 106 of the National Historic Preservation Act. The creation and use of temporary construction staging, and access areas could result in an adverse effect to the NRHP-potentially eligible Cape Cod Canal Historic District. MassDOT will conduct a professional archaeological survey to determine if any unidentified pre-contact sites, unmarked human burials, or ceremonial sites are within the Area of Potential Effect (APE).

### III. Consistency

Describe measures that the proponent will take to comply with federal, state, regional, and local plans and policies related to preserving historical and archaeological resources:

**In March 2022, a Section 106 Programmatic Agreement (PA) was finalized between the USACE, New England District and the Massachusetts State Historic Preservation Officer (SHPO) regarding the Cape Cod Canal Highway Bridges Project, in association with the USACE's MRER/EA and FONSI. The PA was developed in coordination with MassDOT, the MA Board of Underwater Archaeological Resources (MA BUAR), and local interested parties to avoid, minimize, or mitigate the effects of replacing the Cape Cod Canal Highway Bridges on historic properties.**

**It is anticipated that an amended PA and a new Memorandum of Agreement (MOA) among FHWA, SHPO, USACE, and MassDOT will be prepared for the Cape Cod Bridges Program. The MOA and new PA would contain stipulations to address direct and indirect adverse effects to historic properties resulting from the Cape Cod Canal Bridges Program.**

**Additionally, MassDOT will conduct professional archaeological surveys under a State Archaeologist permit or a Federal Archaeological Resources Protection Act Permit to identify, preserve and protect any pre-contact archaeological sites, unmarked human burials, and/or ceremonial sites within the Area of Potential Effect (APE).**

## **CLIMATE CHANGE ADAPTATION AND RESILIENCY SECTION**

This section of the Environmental Notification Form (ENF) solicits information and disclosures related to climate change adaptation and resiliency, in accordance with the MEPA Interim Protocol on Climate Change Adaptation and Resiliency (the "MEPA Interim Protocol"), effective October 1, 2021. The Interim Protocol builds on the analysis and recommendations of the 2018 Massachusetts Integrated State Hazard Mitigation and Climate Adaptation Plan (SHMCAP), and incorporates the efforts of the Resilient Massachusetts Action Team (RMAT), the inter-agency steering committee responsible for implementation, monitoring, and maintenance of the SHMCAP, including the "Climate Resilience Design Standards and Guidelines" project. The RMAT team recently released the RMAT Climate Resilience Design Standards Tool, which is available [here](#).

The MEPA Interim Protocol is intended to gather project-level data in a standardized manner that will both inform the MEPA review process and assist the RMAT team in evaluating the accuracy and effectiveness of the RMAT Climate Resilience Design Standards Tool. Once this testing process is completed, the MEPA Office anticipates developing a formal Climate Change Adaptation and Resiliency Policy through a public stakeholder process. Questions about the RMAT Climate Resilience Design Standards Tool can be directed to [rmat@mass.gov](mailto:rmat@mass.gov).

**All Proponents must complete the following section, referencing as appropriate the results of the output report generated by the RMAT Climate Resilience Design Standards Tool and attached to the ENF.** In completing this section, Proponents are encouraged, but not required at this time, to utilize the recommended design standards and associated Tier 1/2/3 methodologies outlined in the RMAT Climate Resilience Design Standards Tool to analyze the project design. However, Proponents are requested to respond to a respond to a [user feedback survey](#) on the RMAT website or to provide feedback to [rmat@mass.gov](mailto:rmat@mass.gov), which will be used by the RMAT team to further refine the tool. Proponents

are also encouraged to consult general guidance and best practices as described in the [RMAT Climate Resilience Design Guidelines](#).

Climate Change Adaptation and Resiliency Strategies

- I. Has the project taken measures to adapt to climate change for all of the climate parameters analyzed in the RMA Climate Resilience Design Standards Tool (sea level rise/storm surge, extreme precipitation (urban or riverine flooding), extreme heat)? \_\_\_ Yes  No

*Note: Climate adaptation and resiliency strategies include actions that seek to reduce vulnerability to anticipated climate risks and improve resiliency for future climate conditions. Examples of climate adaptation and resiliency strategies include flood barriers, increased stormwater infiltration, living shorelines, elevated infrastructure, increased tree canopy, etc. Projects should address any planning priorities identified by the affected municipality through the Municipal Vulnerability Preparedness (MVP) program or other planning efforts, and should consider a flexible adaptive pathways approach, an adaptation best practice that encourages design strategies that adapt over time to respond to changing climate conditions. General guidance and best practices for designing for climate risk are described in the [RMAT Climate Resilience Design Guidelines](#).*

A. If no, explain why. **RMAT identifies sea level rise/coastal storm surge, urban/riverine flooding, and extreme heat as High Exposure sources of risk for the Program Study Area. In accordance with guidance provided by RMA where “additional site analyses are recommended to establish design values associated with design criteria,” a project specific, locally based, hydraulic model is being developed to inform bridge design and associated project related infrastructure relative to coastal storm surge. A project specific, locally based stormwater model is being developed to inform bridge design and associated roadway infrastructure relative to urban and riverine flooding. Analysis of sea level rise has been conducted to accommodate navigational operational clearance. The MassDOT Bridge Manual requires bridges to be designed for temperature ranges that exceed temperature values provided by RMA. As the Program design advances, notably the development of hydraulic and stormwater models, potential impacts from climate change will be evaluated. Adaptation solutions for each type of risk exposure will be implemented into the proposed bridge and roadway infrastructure design. Adaptation solutions will be addressed in the DEIR. A focus on nature-based solutions will be prioritized as adaptation solutions to the maximum extent practicable.**

B. If yes, describe the measures the project will take, including identifying the planning horizon and climate data used in designing project components. If applicable, specify the return period and design storm used (e.g., 100-year, 24-hour storm).

C. Is the project contributing to regional adaptation strategies?  Yes \_\_\_ No; If yes, describe.

**The Program would contribute to regional adaptation strategies by implementing measures that align with the prioritizes of the Cape Cod Commission, Climate Action Plan (July 2021) and priorities set forth in the Town of Bourne Municipality Vulnerability Preparedness (MVP) Program Community Resilience Building Workshop. These strategies include measures to reduce greenhouse gas emissions by reducing vehicular travel and promoting alternative modes of transportation across the canal. Given the need for evacuation routes, access to national defense facilities, and emergency response, having two new replacement bridges provides an important level of redundancy across Cape Cod Canal. Additionally, the Program allows for an opportunity to implement nature-based solutions within the Program Study Areas.**

- II. Has the Proponent considered alternative locations for the project in light of climate change risks? \_\_\_ Yes  No

A. If no, explain why.

**The Program proposes to replace the existing Bourne and Sagamore bridges with new immediately adjacent twin bridges, which will minimize the extent of realignments to approach roadways and interchange ramps on the Cape and mainland sides of Cape Cod Canal. No alternative locations were considered regarding climate change risks, as the Bourne and Sagamore bridges provide the only roadway connections on and off Cape Cod, which is separated from the mainland by Cape Cod Canal. All alternatives considered for providing safe and reliable long-term vehicular access across the Cape Cod Canal share similar high-risk exposure climate impacts relative to sea level rise, coastal storm surge, extreme heat, urban flooding, and riverine flooding.**

B. If yes, describe alternatives considered.

III. Is the project located in Land Subject to Coastal Storm Flowage (LSCSF) or Bordering Land Subject to Flooding (BLSF) as defined in the Wetlands Protection Act?  Yes \_\_\_ No

If yes, describe how/whether proposed changes to the site's topography (including the addition of fill) will result in changes to floodwater flow paths and/or velocities that could impact adjacent properties or the functioning of the floodplain. General guidance on providing this analysis can be found in the CZM/MassDEP Coastal Wetlands Manual, available [here](#).

**A Program-specific hydrologic model to assess coastal storm inundation and a local stormwater model for inland flood areas are being developed to better understand these conditions. Impacts related to changes to the site's topography will be evaluated in subsequent design stages and discussed in the DEIR, as applicable.**

## **ENVIRONMENTAL JUSTICE SECTION**

### **I. Identifying Characteristics of EJ Populations**

A. If an Environmental Justice (EJ) population has been identified as located in whole or in part within 5 miles of the project site, describe the characteristics of each EJ populations as identified in the EJ Maps Viewer (i.e., the census block group identification number and EJ characteristics of "Minority," "Minority and Income," etc.). Provide a breakdown of those EJ populations within 1 mile of the project site, and those within 5 miles of the site.

**EJ Census Block Groups (BGs) meeting the criteria for Minority and Income are present within both one and five miles of the Program Study Areas as identified in Tables 9-1 through 9-2 in Attachment 1, Section 9, and outlined below. These EJ BGs are identified in the towns of Bourne, Sandwich, and Wareham.**

**The EJ populations within one mile of the Program Study Areas include:**

- **BG 1, Census Tract (CT) 141 – Bourne, Barnstable County – Minority and Income**
- **BG 1, CT 141 – Sandwich, Barnstable County – Minority and Income**

**The EJ populations identified within five miles of the Program Study Areas include:**

- **BG 1, CT 139 – Bourne, Barnstable County – Income**
- **BG 3, CT 140.02 – Bourne, Barnstable County – Income**
- **BG 1, CT 141 – Bourne, Barnstable County – Minority and Income**
- **BG 1, CT 141 – Sandwich, Barnstable County – Minority and Income**
- **BG 1, CT 5452 – Wareham, Plymouth County – Minority**
- **BG 1, CT 5453 – Wareham, Plymouth County - Income**

- B. Identify all languages identified in the “Languages Spoken in Massachusetts” tab of the EJ Maps Viewer as spoken by 5 percent or more of the EJ population who also identify as not speaking English “very well.” The languages should be identified for each census tract located in whole or in part within 1 mile and 5 miles of the project site, regardless of whether such census tract contains any designated EJ populations.

**While the criterion is not met by CTs within one or five miles of the Program Study Areas, there are CTs meeting this criterion for Portuguese or Portuguese Creole in Barnstable, Barnstable County, as described in Attachment 1, Section 9.1.3. The Massachusetts Department of Elementary and Secondary Education (DESE) layer showing languages spoken in the homes of public-school students by zip codes identifies Portuguese language speakers within the Sagamore Program Study Area.**

- C. If the list of languages identified under Section I.B. has been modified with approval of the EEA EJ Director, provide a list of approved languages that the project will use to provide public involvement opportunities during the course of MEPA review. If the list has been expanded by the Proponent (without input from the EEA EJ Director), provide a list of the additional languages that will be used to provide public involvement opportunities during the course of MEPA review as required by Part II of the MEPA Public Involvement Protocol for Environmental Justice Populations (“MEPA EJ Public Involvement Protocol”). If the project is exempt from Part II of the protocol, please specify.

**In coordination with the MassDOT Office of Diversity and Civil Rights, Spanish and Portuguese translation services have been and will be available at all public information meetings, as described in Attachment 1, Section 9.1.4. Relevant program materials, such as the Program comment forms and informational handouts, have been and will be translated into Spanish and Portuguese. American Sign Language and Communication Access Realtime Translation (CART) services have been and will continue to be provided at all public meetings. All other translation services of meetings and materials continue to be available upon request.**

## **II. Potential Effects on EJ Populations**

- A. If an EJ population has been identified using the EJ Maps Viewer within 1 mile of the project site, describe the likely effects of the project (both adverse and beneficial) on the identified EJ population(s).

According to data available through the EEA’s EJ Map Viewer, there is only one Census BG (BG 1, CT 141) designated as EJ for Minority and Income within a one-mile radius of the Program Study Areas. As shown in Attachment 1, Figure 9-1, this identified EJ Census BG is associated with Joint Base Cape Cod (JBCC), which is a full-scale joint-use military base spanning approximately 21,000 acres within the Upper Cape towns of Bourne, Sandwich, and Mashpee. JBCC is home to five military commands from the Department of the Air Force, the United States Coast Guard, the Army National Guard, and the Air National Guard. There are several other tenants on JBCC with affiliation to the Department of Defense, the Department of Homeland Security and other federal, state and county entities. Major missions at JBCC include training for domestic and international operations; emergency response; airborne search and rescue; and intelligence command and control. In addition to supporting military training operations and national security interests, the northern 15,000 acres of JBCC lies above the Upper Cape Water Supply Reserve, which is the sole source aquifer that provides drinking water to JBCC and neighboring towns in Upper Cape Cod.

The Bourne and Sagamore highway bridges are vital to the movement of JBCC personnel, goods, and services, as they provide the only vehicular access points to and from Cape Cod. These approaching 90-year-old bridges have deteriorated over time and require frequent repairs with associated lane closures that are highly disruptive to road users crossing the Cape Cod Canal. In addition to escalating maintenance issues, the substandard design of the bridges and their approaches substantially impairs traffic operations and safety within the vicinity of the Cape Cod Canal.

The Program proposes replacement of the Bourne and Sagamore highway bridges with new bridges to be constructed adjacent to the existing bridges. Design of the new highway bridges will incorporate modern federal highway safety standards such as increased travel lane widths, pedestrian and bicycle lanes with vehicle lanes separation barrier, medians between the two directions of vehicular travel, shoulders to accommodate vehicle breakdowns, and auxiliary lanes to facilitate safe vehicle merging for entrance and exit to adjacent interchanges. The two existing bridges would remain in operation and continue to be inspected and maintained in a safe and reliable condition, while the new bridges are constructed. The current bridges would be decommissioned and demolished once the new bridges are opened to traffic.

Construction of new bridges and reconfiguration of their approaches in conformance with current engineering and design standards would benefit JBCC by improving the safety, efficiency, and reliability of transporting personnel, goods, and services to and from Cape Cod in support of strengthening the security of the Commonwealth and the Nation.

The Program is not anticipated to have adverse effects on the identified EJ population associated with JBCC. The current bridges would remain in operation and continue to be inspected and maintained in a safe and reliable state until the new bridges are built. Each new bridge would be placed in similar alignment and adjacent to the existing bridge to minimize the approach road realignments necessary to connect them to the regional and local transportation network. The Program is not anticipated to have adverse effects on the identified EJ population at JBCC relative to noise or air quality as the proposed transportation improvements would not result in added capacity to the regional or local roadway network. During construction, mitigation measures will be implemented to minimize noise and air quality impacts.

The Program will implement stormwater best management practices in compliance with the governing Massachusetts Wetlands Protection Act Stormwater Management Standards and the U.S. Environmental Protection Agency's National Pollutant Discharge Elimination System (NPDES) Construction Stormwater General Permit. The combination of planned stormwater management improvements, measures for erosion and sedimentation control and avoidance of work within the northern 15,000 acres of JBCC (the Upper Cape Water Supply Reserve), would protect the sole source aquifer that provides drinking water to JBCC and neighboring towns in Upper Cape Cod.

- B. If an EJ population has been identified using the EJ Maps Viewer within 5 miles of the project site, will the project: (i) meet or exceed MEPA review thresholds under 301 CMR 11.03(8)(a)-(b) \_\_\_ Yes  No; or (ii) generate 150 or more new average daily trips (adt) of diesel vehicle traffic, excluding public transit trips, over a duration of 1 year or more. \_\_\_ Yes  No
- C. If you answered "Yes" to either question in Section II.B., describe the likely effects of the project (both adverse and beneficial) on the identified EJ population(s).

### III. Public Involvement Activities

- A. Provide a description of activities conducted prior to filing to promote public involvement by EJ populations, in accordance with Part II of the MEPA EJ Public Involvement Protocol. In particular:
1. If advance notification was provided under Part II.A., attach a copy of the Environmental Justice Screening Form and provide list of CBOs/tribes contacted (with dates). Copies of email correspondence can be attached in lieu of a separate list.

**An EJ Screening Form providing advanced notification of the Program (in English, Spanish, and Portuguese) was distributed via email to stakeholders included on the EJ Reference List on March 13, 2023. Copies of the EJ Reference List and Screen Form are provided in Attachment 9-1.**

2. State how CBOs and tribes were informed of ways to request a community meeting, and if any meeting was requested. If public meetings were held, describe any issues of concern that were raised at such meetings, and any steps taken (including modifications to the project design) to address such concerns.

**The EJ Screening Form provides an opportunity for submitting written comments to MassDOT, including requesting a community meeting. To date, no requests have been received.**

3. If the project is exempt from Part II of the protocol, please specify.

- B. Provide below (or attach) a distribution list (if different from the list in Section III.A. above) of CBOs and tribes, or other individuals or entities the Proponent intends to maintain for the notice of the MEPA Site Visit and circulation of other materials and notices during the course of MEPA review.

**In addition to the EJ Screening Form distribution list (provided in Attachment 9.1), which includes a Program-developed list of local community-based organizations and stakeholder groups serving specific populations, EJ contacts provided by the MEPA Office, and municipal contacts in Bourne and Sandwich, the Program maintains a database of approximately 4,000 contacts through MassDOT's Public Involvement Management Application (PIMA), a web-based application that incorporates elements of GIS to visualize feedback, measure public sentiment and program favorability, and track reach of engagement. The PIMA contacts receive Program update emails on a quarterly basis and as needed (such as to announce meetings, document postings, etc.).**

- C. Describe (or submit as a separate document) the Proponent's plan to maintain the same level of community engagement throughout the MEPA review process, as conducted prior to filing.

**MassDOT will continue working closely with community and advocacy organizations to engage with EJ populations throughout Program development. Attachment 9-2 provides the Program's Public Involvement Plan that will guide MassDOT's approach to communications and outreach during all phases of Program development.**

**CERTIFICATIONS:**

1. The Public Notice of Environmental Review has been/will be published in the following newspapers in accordance with 301 CMR 11.15(1):

(Name) <u>Cape Cod Times</u>	(Date) <u>April 28, 2023</u>
(Name) <u>Cape Cod Chronicle</u>	(Date) <u>April 27, 2023</u>
(Name) <u>The Barnstable Patriot</u>	(Date) <u>April 28, 2023</u>
(Name) <u>El Planeta</u>	(Date) <u>April 27, 2023</u>
(Name) <u>Vocero Hispano</u>	(Date) <u>April 28, 2023</u>
(Name) <u>Provincetown Independent</u>	(Date) <u>April 27, 2023</u>
(Name) <u>Bourne Enterprise</u>	(Date) <u>April 28, 2023</u>
Name) <u>Martha's Vineyard Gazette</u>	(Date) <u>May 5, 2023</u>
(Name) <u>Nantucket Inquirer and Mirror</u>	(Date) <u>May 4, 2023</u>

2. This form has been circulated to Agencies and Persons in accordance with 301 CMR 11.16(2).

Signatures:

<u>Carrie Lavallee</u>	04/24/2023	<u>Anne Canaday</u>
Date Signature of Responsible Officer or Proponent	Date	Signature of person preparing ENF (if different from above)

<u>Carrie Lavallee, P.E., Chief Engineer</u>	<u>Anne Canaday</u>
Name (print or type)	Name (print or type)

<u>MassDOT</u>	<u>MassDOT Highway Division</u>
Firm/Agency	Firm/Agency

<u>10 Park Plaza</u>	<u>10 Park Plaza</u>
Street	Street

<u>Boston, MA 02116</u>	<u>Boston, MA 02116</u>
Municipality/State/Zip	Municipality/State/Zip

<u>857-368-4636</u>	<u>857-368-4636</u>
Phone	Phone



# Attachment 1 Program Narrative

## Table of Contents

<b>1</b>	<b><i>Cape Cod Bridges Program Background</i></b> .....	<b>1</b>
1.1	<b>Program Location and Study Areas</b> .....	<b>4</b>
1.2	<b>Program Purpose and Need</b> .....	<b>7</b>
1.2.1	Program Purpose .....	7
1.2.2	Program Needs .....	7
<b>2</b>	<b><i>Cape Cod Bridges Program Description</i></b> .....	<b>14</b>
2.1	<b>Programmatic and Physical Elements of the Program</b> .....	<b>14</b>
2.1.1	Bridge Type .....	15
2.1.2	Mainline Alignment Location .....	16
2.1.3	Bridge Highway Deck Cross-Section .....	17
2.1.4	Bridge Vertical and Horizontal Clearances .....	18
2.1.5	Highway Interchange Approach Alternatives .....	19
2.2	<b>Program Alternatives Analyses</b> .....	<b>41</b>
2.2.1	U.S. Army Corps of Engineers Alternatives Analysis .....	41
2.2.2	MassDOT Phase 1 and Phase 2 Analyses .....	42
2.3	<b>Program Conceptual Construction Phasing</b> .....	<b>43</b>
<b>3</b>	<b><i>Land Section</i></b> .....	<b>45</b>
3.1	<b>Existing Conditions</b> .....	<b>45</b>
3.1.1	Land Use Overview .....	45
3.1.2	Protected Land Use .....	50
3.2	<b>Environmentally Impacted Land Uses</b> .....	<b>56</b>
3.3	<b>Preliminary Impact Assessment</b> .....	<b>58</b>
3.3.1	Potential Altered Land Areas .....	58
3.3.2	Potential Private Property Impacts .....	60
3.3.3	Potential Open Space Impacts .....	62
3.4	<b>Next Steps</b> .....	<b>64</b>
3.5	<b>Consistency with Planning</b> .....	<b>64</b>
3.5.1	Town of Bourne Local Comprehensive Plan .....	64
3.5.2	Cape Cod Regional Policy Plan .....	66
<b>4</b>	<b><i>Rare Species Section</i></b> .....	<b>69</b>
4.1	<b>Existing Conditions</b> .....	<b>69</b>
4.1.1	Agency Consultation and Coordination .....	72
4.1.2	Rare, Threatened and Endangered Species Habitat Assessment .....	72
4.1.3	Northern Long-Eared Bat Acoustic Survey .....	74
4.2	<b>Preliminary Impact Assessment</b> .....	<b>75</b>
4.3	<b>Next Steps</b> .....	<b>75</b>

<b>5</b>	<b><i>Wetlands, Waterways, and Tidelands Section</i></b> .....	<b>75</b>
5.1	<b>Existing Conditions</b> .....	<b>75</b>
5.2	<b>Preliminary Impact Assessment</b> .....	<b>81</b>
5.3	<b>Next Steps</b> .....	<b>84</b>
5.4	<b>Consistency with Coastal Zone Management Policies</b> .....	<b>84</b>
5.4.1	Coastal Hazards Policies .....	84
5.4.2	Energy Policies .....	86
5.4.3	Growth Management Policies .....	86
5.4.4	Habitat Policies .....	87
5.4.5	Ocean Resources Policies .....	87
5.4.6	Ports and Harbors Policies.....	88
5.4.7	Protected Areas Policies.....	89
5.4.8	Public Access Policies.....	89
5.4.9	Water Quality Policies .....	90
<b>6</b>	<b><i>Transportation Section</i></b> .....	<b>91</b>
6.1	<b>Existing Conditions</b> .....	<b>91</b>
6.1.1	Bourne and Sagamore Bridges .....	91
6.1.2	Major Highways in the Program Study Area .....	95
6.1.3	Major Intersections in the Program Study Area .....	97
6.1.4	Pedestrian and Bicycle Facilities .....	98
6.1.5	Cape Cod Canal Navigation.....	99
6.1.6	Airports.....	100
6.1.7	Transit and Parking Facilities .....	100
6.2	<b>Preliminary Impacts Assessment</b> .....	<b>101</b>
6.2.1	Transportation Facility Impacts .....	101
6.2.2	Cape Cod Canal Navigation.....	102
6.2.3	Airports.....	103
6.2.4	Transit and Parking Facilities .....	103
6.3	<b>Next Steps</b> .....	<b>103</b>
6.4	<b>Induced Visitor Travel Demand</b> .....	<b>104</b>
6.5	<b>Consistency with Plans and Policies</b> .....	<b>105</b>
6.5.1	Massachusetts Bicycle Transportation Plan .....	105
6.5.2	Massachusetts Pedestrian Transportation Plan .....	106
6.5.3	Cape Cod 2020 Regional Transportation Plan .....	106
<b>7</b>	<b><i>Historic and Archaeological Resources Section</i></b> .....	<b>107</b>
7.1	<b>Existing Conditions</b> .....	<b>107</b>
7.1.1	Inventoried Historic Resources.....	107
7.1.2	Archaeological Resources .....	111
7.2	<b>Preliminary Impacts Assessment</b> .....	<b>111</b>
7.3	<b>Section 106 Consultation</b> .....	<b>111</b>
7.3.1	Early Consultation.....	111
7.3.2	Programmatic Agreement and Memorandum of Agreement.....	112

7.4	Next Steps .....	113
7.5	Consistency with Preservation Plans and Policies.....	113
<b>8</b>	<b><i>Climate Change Adaptation and Resiliency Section</i></b> .....	<b>114</b>
8.1	Measures to Adapt to Climate Change.....	114
8.1.1	Sea Level Rise .....	114
8.1.2	Coastal Storm Surge .....	116
8.1.3	Extreme Heat.....	116
8.1.4	Urban Flooding .....	117
8.1.5	Riverine Flooding.....	117
8.2	Conformance with Regional Adaptation Strategies .....	117
8.3	Alternative Project Locations .....	118
8.4	Potential Impacts to Floodwater Flow Paths, Velocities, Floodplain .....	118
8.5	Next Steps .....	118
<b>9</b>	<b><i>Environmental Justice Section</i></b> .....	<b>119</b>
9.1	Identifying Characteristics of Environmental Justice Populations.....	119
9.1.1	Environmental Justice Populations and Characteristics within One Mile and Five Miles of the Program Study Areas.....	119
9.1.2	Languages .....	122
9.1.3	Approved Languages for Public Involvement .....	122
9.1.4	Existing Unfair Inequitable Environmental Burdens.....	122
9.2	Overview of Adjacent Communities .....	123
9.3	Potential Effects on Environmental Justice Populations .....	130
9.3.1	Program Benefits .....	130
9.3.2	Overall Potential Impacts and Mitigation Measures .....	131
9.3.3	Anticipated Effects upon Environmental Justice Communities.....	132
9.4	Public Involvement Activities .....	132
9.4.1	MEPA Advance Notice .....	132
9.4.2	Program Outreach .....	133
9.4.3	Program Contacts .....	138
9.5	Next Steps .....	139

## Figures

<b>Figure 1-1.</b>	<b><i>Bourne and Sagamore Highway Bridges Location Map.....</i></b>	<b>2</b>
<b>Figure 1-2.</b>	<b><i>Cape Cod Bridges Program – Bourne Program Study Area .....</i></b>	<b>5</b>
<b>Figure 1-3.</b>	<b><i>Cape Cod Bridges Program – Sagamore Program Study Area.....</i></b>	<b>6</b>
<b>Figure 2-1.</b>	<b><i>Conceptual Rendering of the Tied-Arch Bridges Preferred Alternative – Cape Cod Canal Viewpoint.....</i></b>	<b>15</b>

<b>Figure 2-2. Conceptual Rendering of the Tied-Arch Bridges Preferred Alternative – Driver Viewpoint.....</b>	<b>16</b>
<b>Figure 2-3. Bourne Bridge Replacement Mainline Alignment Location .....</b>	<b>16</b>
<b>Figure 2-4. Sagamore Bridge Replacement Mainline Alignment Location.....</b>	<b>17</b>
<b>Figure 2-5. Schematic of Replacement Bridge Structure Cross-Section .....</b>	<b>18</b>
<b>Figure 2-6. Replacement Bridge Main Span and Pier Location.....</b>	<b>19</b>
<b>Figure 2-7. Bourne North Crossing Interchange Approach - Northbound On-Ramp Alternative .....</b>	<b>21</b>
<b>Figure 2-8. Bourne North Crossing Interchange Approach - Single Exit Partial Interchange Alternative.....</b>	<b>23</b>
<b>Figure 2-9. Bourne North Crossing Interchange Approach - Directional Interchange Alternative .....</b>	<b>25</b>
<b>Figure 2-10. Bourne South Crossing Interchange Approach - Diamond Interchange Alternative.....</b>	<b>27</b>
<b>Figure 2-11. Bourne South Crossing Interchange Approach - Single-Point Interchange Alternative ...</b>	<b>29</b>
<b>Figure 2-12. Sagamore North Crossing Interchange Approach - Similar to Existing Configuration Alternative.....</b>	<b>31</b>
<b>Figure 2-13. Sagamore North Crossing Interchange Approach - Direct Connection to State Road Alternative.....</b>	<b>33</b>
<b>Figure 2-14. Sagamore South Crossing Interchange Approach - Similar to Existing Configuration with Cranberry Highway Extension Alternative .....</b>	<b>35</b>
<b>Figure 2-15. Sagamore South Crossing Interchange Approach - Similar to Existing Configuration Alternative.....</b>	<b>37</b>
<b>Figure 2-16. Sagamore South Crossing Interchange Approach - Westbound On-Ramp Under Route 6 Alternative.....</b>	<b>39</b>
<b>Figure 2-17. Proposed Bridge Replacement Temporary Traffic Configuration .....</b>	<b>43</b>
<b>Figure 2-18. Schematic of Proposed Bridge Replacement Construction Phasing Approach .....</b>	<b>44</b>
<b>Figure 3-1. Existing Land Uses in the Bourne North Program Study Area .....</b>	<b>46</b>
<b>Figure 3-2. Existing Land Uses in the Bourne South Program Study Area .....</b>	<b>47</b>
<b>Figure 3-3. Existing Land Uses in the Sagamore North Program Study Area.....</b>	<b>48</b>
<b>Figure 3-4. Existing Land Uses in the Sagamore South Program Study Area.....</b>	<b>49</b>
<b>Figure 3-5. Protected Open Space in the Bourne North Program Study Area.....</b>	<b>51</b>
<b>Figure 3-6. Protected Open Space in the Bourne South Program Study Area.....</b>	<b>52</b>
<b>Figure 3-7. Protected Open Space in the Sagamore North Program Study Area .....</b>	<b>53</b>
<b>Figure 3-8. Protected Open Space in the Sagamore South Program Study Area .....</b>	<b>54</b>

**Figure 3-9. Environmentally Impacted Land Uses in and Near the Program Study Areas..... 57**

**Figure 4-1. NHESP Estimated and Priority Habitat in the Bourne Program Study Area ..... 70**

**Figure 4-2. NHESP Estimated and Priority Habitat in the Sagamore Program Study Area..... 71**

**Figure 5-1. Wetlands and Waterways in the Bourne North Program Study Area..... 76**

**Figure 5-2. Wetlands and Waterways in the Bourne South Program Study Area..... 77**

**Figure 5-3. Wetlands and Waterways in the Sagamore North Program Study Area..... 78**

**Figure 5-4. Wetlands and Waterways in the Sagamore South Program Study Area ..... 79**

**Figure 5-5. Coastal Resources in the Bourne and Sagamore Program Study Areas..... 80**

**Figure 6-1. Cape Cod Bridges Program Regional Transportation Network ..... 92**

**Figure 6-2. Vehicular and Bicycle Transportation Network in the Bourne Program Study Area..... 93**

**Figure 6-3. Vehicular and Bicycle Transportation Network in the Sagamore Program Study Area ..... 94**

**Figure 7-1. Historic Properties in and near the Bourne Program Study Area ..... 109**

**Figure 7-2. Historic Properties in and near the Sagamore Program Study Area..... 110**

**Figure 9-1. Environmental Justice Communities within 1-mile and 5-miles of Program Study Areas 120**

**Figure 9-2. Villages in and Near the Program Study Areas ..... 124**

**Tables**

**Table 1-1. Crash Data Summary by Type – 2017 to 2019 ..... 14**

**Table 2-1. Summary of Highway Interchange Approach Alternatives ..... 40**

**Table 3-1. Bourne North Program Study Area – Estimated Acres of Land Alteration ..... 58**

**Table 3-2. Bourne South Program Study Area – Estimated Acres of Land Alteration ..... 59**

**Table 3-3. Sagamore North Program Study Area – Estimated Acres of Land Alteration..... 59**

**Table 3-4. Sagamore South Program Study Area – Estimated Acres of Land Alteration..... 60**

**Table 3-5. Bourne Program Study Area – Estimated Permanent Private Property Impacts..... 61**

**Table 3-6. Sagamore Program Study Area – Estimated Permanent Private Property Impacts ..... 61**

**Table 3-7. Bourne Program Study Area – Potential Open Space Impacts ..... 62**

**Table 3-8. Sagamore Program Study Area – Potential Open Space Impacts..... 63**

**Table 4.1. MESA-Listed Species by Taxonomic Group Identified in the Program Study Areas..... 72**

**Table 5-1. Bourne Program Study Area – Estimated Impacts..... 83**

**Table 5-2. Bourne Program Study Area – Estimated Buffer Zone Impacts ..... 83**

**Table 5-3. Sagamore Program Study Area – Estimated Impacts ..... 83**

<b>Table 6-1. Bourne Program Study Area – Estimated Transportation Facility Impacts .....</b>	<b>101</b>
<b>Table 6-2. Sagamore Program Study Area – Estimated Transportation Facility Impacts.....</b>	<b>102</b>
<b>Table 7-1. Historic Resources in the Bourne and Sagamore Program Study Areas.....</b>	<b>107</b>
<b>Table 8-1. List of Reviewed Climate Data Sources .....</b>	<b>115</b>
<b>Table 9-1. EJ Populations within One Mile of the Program Study Areas.....</b>	<b>121</b>
<b>Table 9-2. EJ Populations within Five Miles of the Program Study Areas.....</b>	<b>121</b>
<b>Table 9-3. Select Characteristics of EJ BGs within Five Miles of the Program Study Areas.....</b>	<b>122</b>
<b>Table 9-5. Vulnerable EJ Health Criteria.....</b>	<b>123</b>
<b>Table 9-6. Demographics Profiles – Communities within the Vicinity of the Program Study Areas...</b>	<b>125</b>
<b>Table 9-7. Household Profiles – Communities within the Vicinity of the Program Study Areas .....</b>	<b>126</b>
<b>Table 9-8. Employment Profiles – Communities within the Vicinity of the Program Study Areas .....</b>	<b>127</b>
<b>Table 9-9. Program Public Meetings.....</b>	<b>136</b>
<b>Table 9-10. Program Targeted Public Events.....</b>	<b>137</b>

## Exhibits

<b>Exhibit 1-1. Fracture Critical Gusset Plate Deterioration, Bourne Bridge 2020.....</b>	<b>8</b>
<b>Exhibit 1-2. Fracture Critical Gusset Plate Deterioration, Sagamore Bridge 2021 .....</b>	<b>9</b>
<b>Exhibit 1-3. Traffic Backup on Route 6 Westbound During Sagamore Bridge Maintenance Work.....</b>	<b>10</b>
<b>Exhibit 1-4. Vehicular and Pedestrian Traffic Crossing the Bourne Bridge .....</b>	<b>11</b>

## List of Acronyms

**AAB** – Architectural Access Board  
**AASHTO** – American Association of State Highway and Transportation Officials  
**ACEC** – Area of Critical Environmental Concern  
**ACS** – American Community Survey  
**ADA** – Americans with Disabilities Act  
**ADT** – Average Daily Traffic  
**ANRAD** – Abbreviated Notice of Resource Area Delineation  
**APE(s)** – Areas of Potential Effect  
**ASL** – American Sign Language  
**BFE** – Base Flood Elevation  
**BLSF** – Bordering Land Subject to Flooding  
**BMP(s)** – Best Management Practices  
**BN** – Bourne North  
**BS** – Bourne South  
**BUAR** – Board of Underwater Archaeological Resources  
**BVW** – Bordering Vegetated Wetlands  
**CAF** – Capacity Adjustment Factors  
**CART** – Communication, Access, Realtime Translation  
**CCBP** – Cape Cod Bridges Program  
**CCC TIP** – Cape Cod Canal Area Transportation Improvement Program  
**CCRTA** – Cape Cod Regional Transit Authority  
**CCTS** – Cape Cod Canal Transportation Study  
**CDWM** – Construction and Demolition Waste Management Plan  
**CMR** – Code of Massachusetts Regulations  
**CF** – Cubic Feet  
**CFR** – Code of Federal Regulations  
**CWA** – United States Clean Water Act  
**CZM** – Coastal Zone Management  
**DCR** – Massachusetts Department of Conservation and Recreation  
**DEIR** – Draft Environmental Impact Report  
**DPA** – Designated Port Area  
**EA** – Environmental Assessment  
**EIR** – Environmental Impact Report  
**EJ** – Environmental Justice  
**ENF** – Environmental Notification Form  
**ESA** – Endangered Species Act  
**FAA** – Federal Aviation Administration



**FCM** – Fracture Critical Members  
**FEMA** – Federal Emergency Management  
**FHWA** – Federal Highway Administration  
**FNP** – Federal Navigation Project  
**FONSI** – Finding of No Significant Impact  
**GHG** – Greenhouse Gas  
**GIZ** – Growth Incentive Zone  
**GPR** – Ground Penetrating Radar  
**HCM** – Highway Capacity Manual  
**IAGWSP** – Impact Area Groundwater Study Program  
**IHSDM** – Interactive Highway Safety Design Manual  
**ILSF** – Isolated Land Subject to Flooding  
**JBCC** – Joint Base Cape Cod  
**LCP** – Local Comprehensive Plan  
**LEP** – Limited English Populations  
**LID** – Low Impact Development  
**LOS** – Level of Service  
**LSCSF** – Land Subject to Coastal Storm Flowage  
**MGL** – Massachusetts General Law  
**MA EEA** – Massachusetts Executive Office of Energy and Environmental Affairs  
**MA WPA** – Massachusetts Wetlands Protection Act  
**MassDEP** – Massachusetts Department of Environmental Protection  
**MassDOT** – Massachusetts Department of Transportation  
**MassWildlife** – Massachusetts Division of Fisheries and Wildlife  
**MC-FRM** – Massachusetts Coast Flood Risk Model  
**MCP** – Massachusetts Contingency Plan  
**MEPA** – Massachusetts Environmental Policy Act  
**MESA** – Massachusetts Endangered Species Act  
**MHC** – Massachusetts Historic Commission  
**MHW** – Mean High Water  
**MMR** – Massachusetts Military Reservation  
**MOA** – Memorandum of Agreement  
**MOE(s)** – Measures of Effectiveness  
**MOU** – Memorandum of Understanding  
**MPH** – Miles Per Hour  
**MRE** – Major Rehabilitation Evaluation  
**MRER** – Major Rehabilitation Evaluation Report  
**MVMT** – Million Vehicle Miles Traveled  
**NAICS** – North American Industry Classification System  
**NB** – Northbound  
**NBFD** – Not Being Further Developed

**NEPA** – National Environmental Policy Act  
**NHESP** – Natural Heritage and Endangered Species Program  
**NHPA** – National Historic Preservation Act  
**NLEB** – Northern Long-Eared Bat  
**NOAA** – National Oceanic and Atmospheric Administration  
**NP&EDC** – Nantucket Planning and Economic Development Commission  
**NPDES** – National Pollution Discharge Elimination System  
**NRHP** – National Register of Historic Places  
**OD** – Origin-Destination  
**ORAD** – Order of Resource Area Delineation  
**PA** – Programmatic Agreement  
**PDDG** – Project Development and Design Guide  
**PI** – Public Involvement  
**PIMA** – Public Involvement Management Application  
**PIP** – Public Involvement Plan  
**PVP** – Potential Vernal Pools  
**RMAT** – Resilient Massachusetts Action Team  
**ROW** – Right-of-Way  
**RPP** – Regional Policy Plan  
**RTE** – Rare, Threatened, and Endangered Species  
**RTP** – Regional Transportation Plan  
**SAF** – Safety Adjustment Factors  
**SB** – Southbound  
**SF** – Square Feet  
**SHMCAP** – State Hazard Mitigation and Climate Adaptation Plan  
**SHPO** – State Historic Preservation Officer  
**SLR** – Sea Level Rise  
**SN** – Sagamore North  
**SPI** – Single Point Interchange  
**SRHP** – State Register of Historic Places  
**SRPEDD** – Southeastern Regional Planning & Economic Development Commission  
**SS** – Sagamore South  
**SWOT** – Strengths, Weaknesses, Opportunities, and Threats  
**TAZ** – Traffic Analysis Zone  
**TBD** – To Be Determined  
**THPOs** – Tribal Historic Preservation Officers  
**TIP** – Transportation Improvement Program  
**TRB** – Transportation Research Board  
**UMDI** – UMass Donahue Institute  
**USACE** – U.S. Army Corps of Engineers  
**USC** – United States Code

**USFWS** – U.S. Fish and Wildlife Service  
**VPI** – Virtual Public Involvement  
**WCSC** – Waterborne Commerce Statistics Center  
**WOTUS** – Waters of the United States

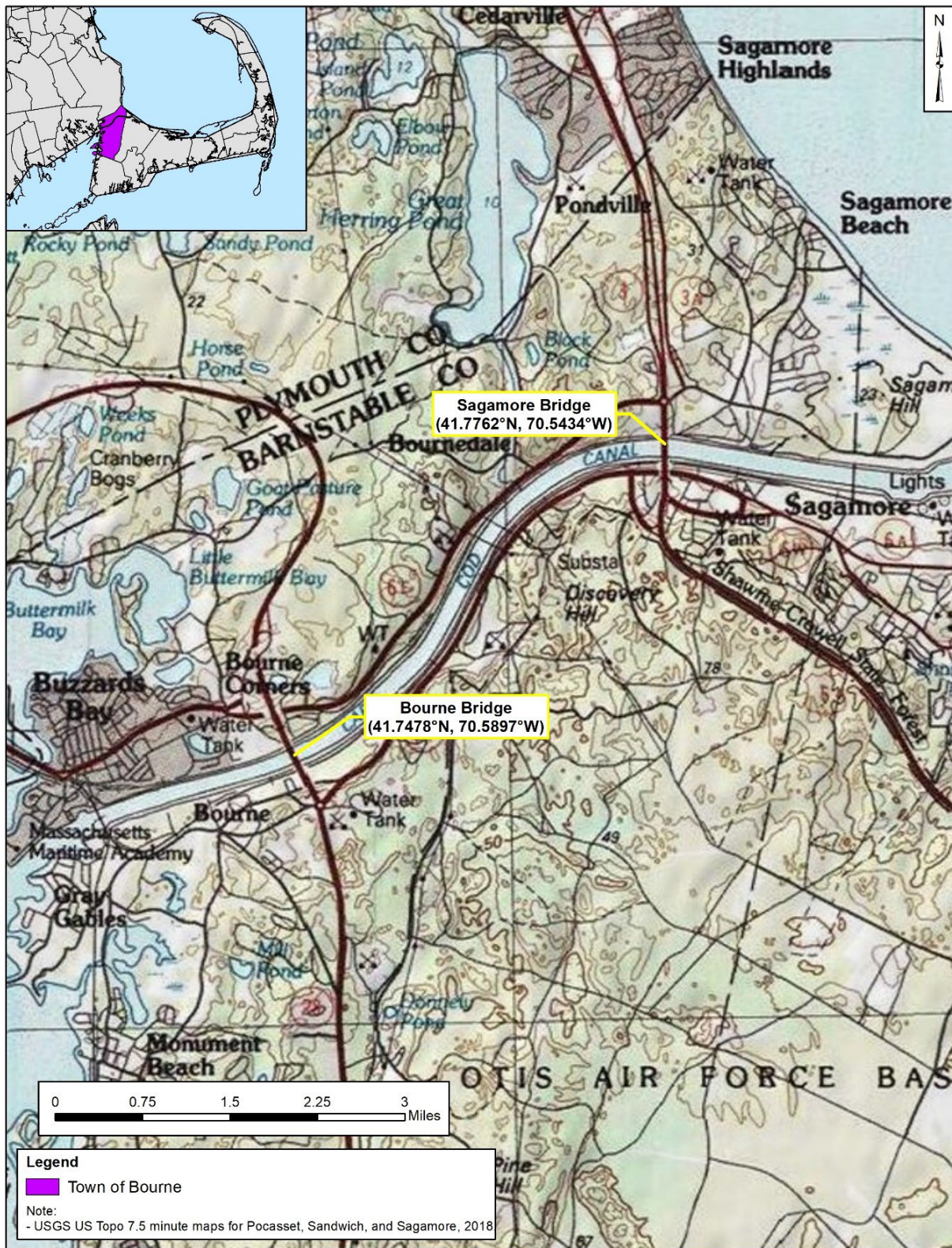
# 1 Cape Cod Bridges Program Background

The Bourne and Sagamore highway bridges, located in the town of Bourne, Barnstable County, Massachusetts (Figure 1-1), are components of the authorized Cape Cod Canal Federal Navigation Project (FNP), which is operated and maintained by the USACE, New England District. Opening to vessel traffic in 1914, Cape Cod Canal was constructed to provide a shorter and safer navigable intra-coastal shipping route from northern New England ports to other areas on the U.S. eastern seaboard. The canal is open for passage to all properly equipped and seaworthy boating craft, serving as an important maritime navigational route for commercial, military, and recreational vessels.

The Bourne and Sagamore bridge crossings over Cape Cod Canal are vital assets for the economy of Cape Cod and the surrounding communities, serving as the gateway to Cape Cod for more than 250,000 year-round residents of the Cape and Islands (Barnstable, Dukes, and Nantucket Counties), and millions of annual visitors during the height of the summer tourist season from Memorial Day through Labor Day. With more than 38 million vehicles crossing Cape Cod Canal each year, the Bourne and Sagamore bridges are the only access points for vehicular traffic to and from Cape Cod and serve as essential routes for general transportation, freight distribution, tourism, emergency evacuations, and access to major national defense facilities at Joint Base Cape Cod.

The existing Bourne and Sagamore bridges were constructed beginning in 1933, when Cape Cod Canal was widened, and opened to traffic in 1935, replacing two original low-level drawbridges. At nearly 90 years old, both bridges are in deteriorated condition and have undergone a typical history of costly maintenance, repair and rehabilitation with extended lane closures that are highly disruptive to traffic crossing Cape Cod Canal. In addition to escalating maintenance issues, the aging Bourne and Sagamore bridges do not meet current highway safety standards or adequately reflect modern day traffic conditions. The combination of today's high traffic volumes and substandard design features of the Bourne and Sagamore bridges and their approach roadway network increases congestion and crash vulnerability within vicinity of Cape Cod Canal.

In response to the aging condition of the Bourne and Sagamore bridges, and substantial traffic congestion that Cape Cod residents and visitors often contend with during the summer and the fall and spring shoulder seasons, MassDOT, in collaboration with the Federal Highway Administration (FHWA), launched the Cape Cod Canal Transportation Study (CCTS) in 2015 to identify and evaluate existing and future multimodal transportation deficiencies and needs around the Cape Cod Canal area. The mainline roadways approaching the bridges, consisting of Route 25 and Route 28 at the Bourne Bridge and Route 3 and Route 6 at the Sagamore Bridge, are owned, and maintained by the MassDOT Highway Division. The local roadways that connect to the mainline roadways are owned by



**Figure 1-1. Bourne and Sagamore Highway Bridges Location Map**

either MassDOT or the Town of Bourne. The CCTS process involved a Study Working Group, including local and state elected officials, federal and state agencies, area municipalities, metropolitan planning organizations, chambers of commerce, key businesses, and other interested parties, and an extensive public outreach program. At the conclusion of the CCTS in 2019, MassDOT, in coordination with the Study Working Group, provided the following recommendations for addressing multimodal deficiencies within the Cape Cod Canal area:

- Improve and expand bicycle/pedestrian connections proximate to and from local roadways over Cape Cod Canal via the Bourne and Sagamore bridges;
- Implement major transportation system improvements at roadway approaches to the Bourne and Sagamore bridges.

The completed CCTS and related public engagement documentation are provided on [MassDOT's study website](#).

The USACE, New England District completed a multi-year Major Rehabilitation Evaluation (MRE) of the Bourne and Sagamore highway bridges in 2020. The USACE is tasked with completing an MRE when infrastructure maintenance construction costs are expected to exceed \$20 million, and construction will take more than two years to be completed. The purpose of the MRE was to evaluate the current condition of the bridges and determine whether standard operation and maintenance, major rehabilitation, or replacement of either or both bridges would provide the most reliable, fiscally responsible solution for the future. The MRE resulted in publication of a Major Rehabilitation Evaluation Report (MRER) in March 2020, which evaluated the risk and reliability of the Bourne and Sagamore bridges, as well as the economic impacts and benefits of numerous alternatives, including continuation of routine maintenance, major rehabilitation, or bridge replacement. As part of the MRER process, the USACE completed an Environmental Assessment (EA) pursuant to the requirements of the National Environmental Policy Act (NEPA) to analyze the potential environmental effects of all feasible alternatives. Five agencies including MassDOT, FHWA, U.S. Coast Guard (USCG), U.S. Environmental Protection Agency (U.S. EPA) and the National Marine Fisheries Service (NMFS) participated in the MRER/EA as cooperating agencies. Based on a detailed evaluation of the costs and benefits of all feasible alternatives, the MRER/EA concluded that replacement of the current bridges with two new bridges built to modern-day highway design standards provides the best long-term investment for safe and reliable access across Cape Cod Canal. Further, the USACE determined that the replacement of both highway bridges with new bridges (Preferred Alternative) would not have significant adverse impact on the environment. On March 29, 2022, the USACE formally issued a Finding of No Significant Impact (FONSI) for the proposed action to replace the Bourne and Sagamore bridges. The completed MRER/EA and supporting documentation can be accessed via the [USACE New England District's website](#).

Together, the findings of the 2019 CCTS and the 2020 MRER/EA have led to partnerships among FHWA, USACE and MassDOT to replace the aging Bourne and Sagamore bridges, as well as reconfigure the surrounding approach roadway networks through the Cape Cod Bridges Program.

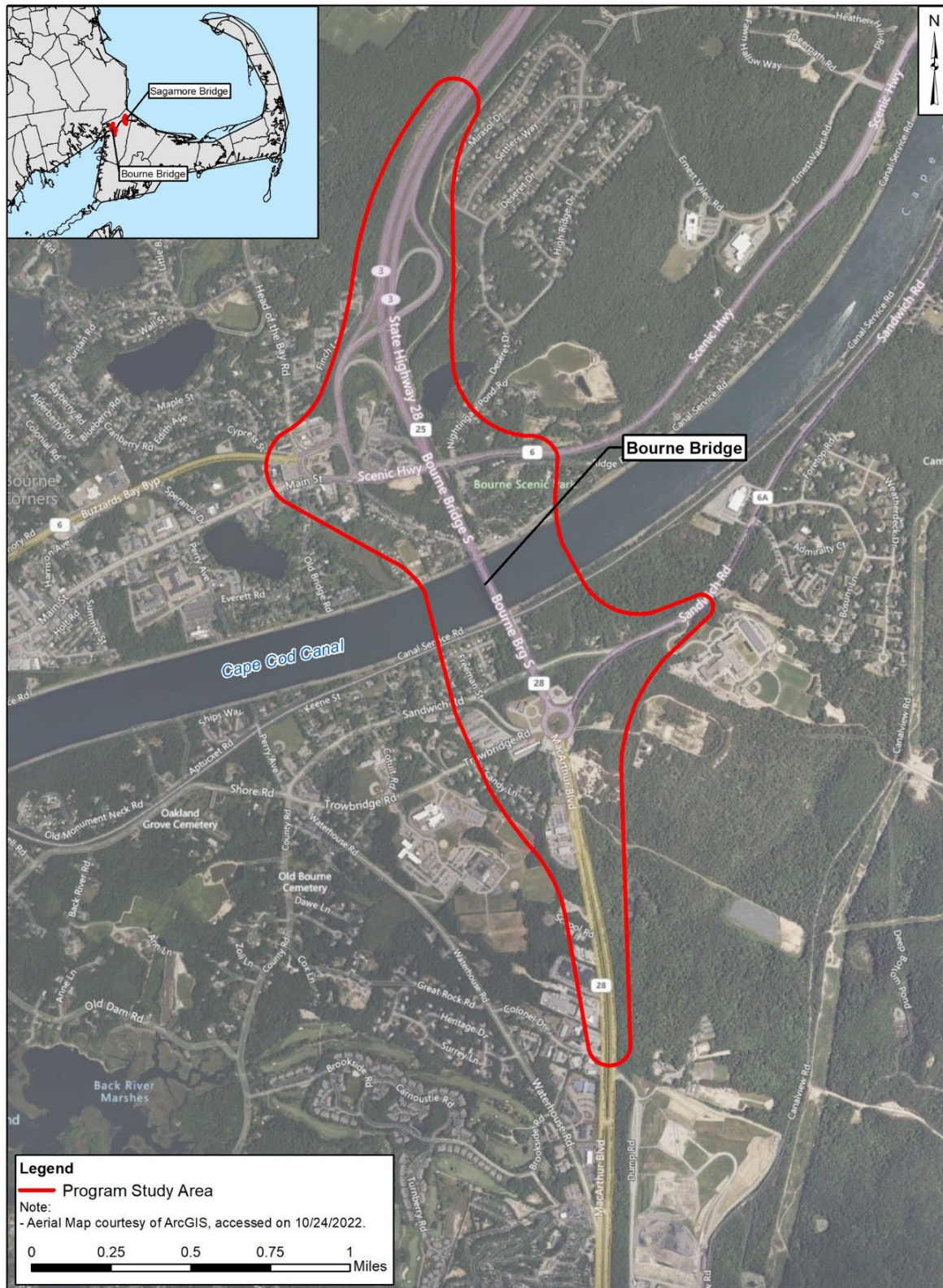
A Memorandum of Understanding (MOU) was executed on July 7, 2020, between the USACE and MassDOT regarding the future ownership, operations, and maintenance of the Bourne and Sagamore highway bridges. According to the terms of the agreement, USACE is responsible for the ownership, operation, and maintenance of the two existing bridges until replacement bridges are built and operational, all the while providing information and support to MassDOT. MassDOT is responsible for leading program delivery (feasibility study, alternatives analysis, preliminary design, and environmental permitting processes), as well as overseeing procurement and construction of the new bridges. MassDOT will then own, operate, and maintain the completed bridges and approaches as part of the system of state highways to be maintained by MassDOT.

## 1.1 Program Location and Study Areas

The Cape Cod Bridges Program Study Area is divided into two distinct study areas in the town of Bourne, as shown in Figures 1-2 and 1-3. The two Program Study Areas include the areas of the existing bridges and highway approach intersections for each crossing.

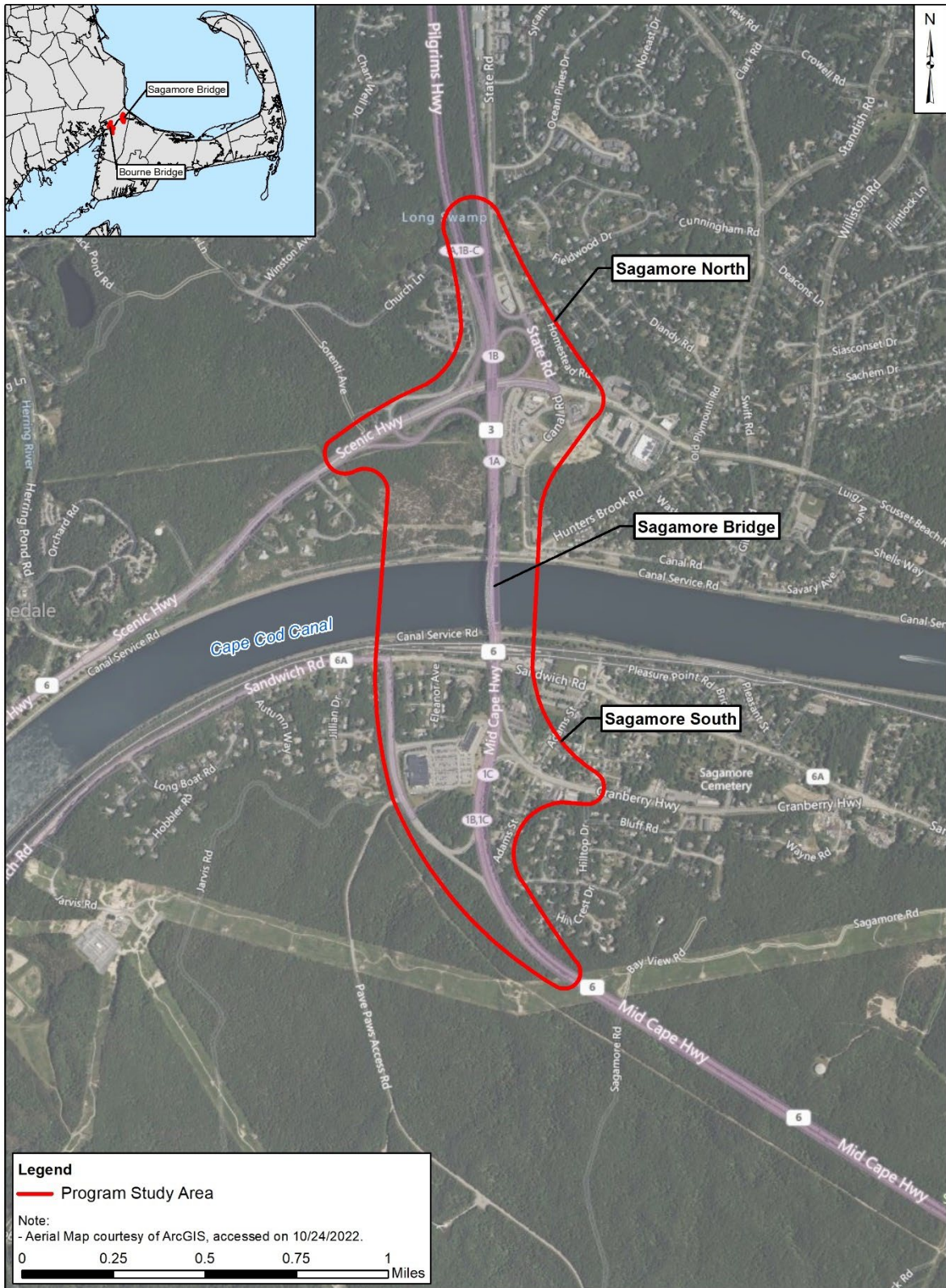
The Bourne Program Study Area includes the Route 25 and Route 28 approaches to the bridge. North of Cape Cod Canal (Bourne North), roadways include Route 6 (Scenic Highway) and the roadways approaching Belmont Circle, including the Route 25 exit- and entrance-ramps and portions of the Head of the Bay Road, Main Street, and the Buzzards Bay Bypass. South of the canal (Bourne South), roadways include the Bourne Rotary and approach roadways including Route 28, Sandwich Road, and Trowbridge Road, Veterans Way, and the Bourne Rotary Connector.

The Sagamore Program Study Area includes the Route 3 and Route 6 approaches to the bridge. North of Cape Cod Canal (Sagamore North), roadways include the Scenic Highway and Meetinghouse Lane approaches, the Route 3/Scenic Highway interchange, and portions of Canal Street and State Road. South of the canal (Sagamore South), roadways include Cranberry Highway and Sandwich Road and Route 6 itself extending south of the Mid-Cape Connector ramps to Route 6.



**Figure 1-2. Cape Cod Bridges Program – Bourne Program Study Area**





**Figure 1-3. Cape Cod Bridges Program – Sagamore Program Study Area**

## 1.2 Program Purpose and Need

### 1.2.1 Program Purpose

The purpose of the Cape Cod Bridges Program is to improve cross-canal mobility and accessibility between Cape Cod and mainland Massachusetts for all road users and to address the increasing maintenance needs and functional obsolescence of the aging Cape Cod Canal highway bridges. The Program will improve traffic operations and multimodal accommodations to facilitate the dependable and efficient movement of people, goods, and services across Cape Cod Canal.

### 1.2.2 Program Needs

In coordination with FHWA and USACE, MassDOT is undertaking the Cape Cod Bridges Program to address the following needs, or deficiencies of the Bourne and Sagamore bridges and their roadway approach networks for road users crossing Cape Cod Canal:

- Structural deficiencies of the Bourne and Sagamore bridges, including their frequent maintenance requirements;
- Substandard design of the Bourne and Sagamore bridges, including the approaches and their interface with the adjacent roadway network;
- Peak period congestion and poor traffic operations.

#### 1.2.2.1 Bridge Structural Deficiencies

Despite ongoing maintenance efforts and major rehabilitation of superstructure components in 1981, the nearly 90-year-old Bourne and Sagamore bridges have deteriorated over time and are now beyond their functional service lives. Both bridges undergo a regular cycle of inspection, consistent with current National Bridge Inspection Standards (NBIS). These routine inspections are conducted to characterize the existing conditions of the deck, superstructure, and substructure, thus allowing the USACE to identify bridge components in need of maintenance, repairs, rehabilitation and/or replacement. Individual bridge components of the deck, superstructure, and substructure are categorized as either “GOOD,” “FAIR,” “POOR,” or “CRITICAL” where these classifications are based on a scale of 0 to 9 (with 0 scoring as a failed condition, and 9 scoring as an excellent condition). A bridge qualifies as structurally deficient if the condition rating is less than or equal to 4 (in poor or worse condition) for the bridge deck, superstructure, or substructure.

Based on latest information available from a routine inspection conducted by USACE in October 2020<sup>1</sup>, the Bourne Bridge was classified as structurally deficient. The deck was in fair condition with a condition rating of 5 due to continuing deterioration in the abutment spans. The superstructure was in poor condition with a rating of 4 due to continuing deterioration of the concrete T-beams, deterioration of gusset plates at truss joints (as shown in Exhibit 1-1), and broken anchor bolts at truss expansion bearings. Gusset plates are considered fracture critical members (FCM), meaning the failure of one of these elements will likely lead to catastrophic failure of an entire span. The substructure was in good condition with a condition rating of 7, although delamination and spalling were noted in the bridge

---

<sup>1</sup> TranSystems Corporation, Routine Inspection Report, Volume I of III; 2020 Routine Inspection of the Bourne Bridge over the Cape Cod Canal, February 2021.

abutment walls. The “structurally deficient” classification does not imply that the bridge is unsafe for travel. However, the classification is an indication that the bridge requires maintenance and repair and eventual rehabilitation or replacement to address existing deficiencies.

**Exhibit 1-1. Fracture Critical Gusset Plate Deterioration, Bourne Bridge 2020**



The Sagamore Bridge was not considered to be structurally deficient as of the latest available inspection conducted by the USACE in September 2021<sup>2</sup>. The deck was in fair condition with an overall rating of 5. The superstructure and substructure were also in fair condition with overall ratings of 5. Although the 2021 inspection findings warranted condition ratings of fair for the deck, superstructure and substructure, individual bridge components warranted overall ratings of poor, such as the fracture critical gusset plates (as shown in Exhibit 1-2) and other connection plates.

---

<sup>2</sup> TranSystems Corporation, Routine Inspection Report, Volume I of III; 2021 Routine Inspection of the Sagamore Bridge over the Cape Cod Canal, January 2022.

## Exhibit 1-2. Fracture Critical Gusset Plate Deterioration, Sagamore Bridge 2021



There are several unrepaired truss joint gusset plates on three spans of the west truss and two spans of the east truss of the Sagamore Bridge that exhibit areas of advanced section loss and deformation due to pack rust. In addition to continuing deterioration, the Sagamore Bridge is vulnerable to fatigue. Fatigue, which is progressive in nature, refers to failure of structural steel members under repeated stress cycles such as traffic loading. The truss spans of the Bourne and Sagamore bridges are fracture critical.

The age of the Bourne and Sagamore bridges, combined with heavy vehicular demands and the corrosive saltwater environment of Cape Cod, necessitates frequent, costly, and escalating maintenance and repairs to maintain the structures in a state of good repair. All repair work on the superstructure and bridge deck requires vehicular lane closures to facilitate contractor activities. Typically, these lane closures restrict travel to one lane in each direction. Historically, temporary lane closures have been in effect for a minimum of approximately nine months during repair contracts. Full closure of the bridge would be required for shorter time periods (about 2 weeks) multiple times during a major rehabilitation to allow replacement of certain critical bridge components, such as interior gusset plates and floor beams. These prolonged lane restrictions and full bridge closures likely would result in lengthy traffic delays, with congestion extending far beyond the project area. Exhibit 1-3 shows a typical traffic back up scenario during bridge maintenance work.

### Exhibit 1-3. Traffic Backup on Route 6 Westbound During Sagamore Bridge Maintenance Work



Based on criteria provided in the MassDOT Load and Resistance Factor Design (LRFD) bridge design specifications, the Bourne and Sagamore bridges are designated as “Critical and Essential Bridges,” which must be operational following a natural disaster or other event. The approaching 90-year-old Bourne and Sagamore bridges do not meet current seismic design standards. Given the age and underlying structural deficiencies of the existing bridges, they could be vulnerable to damage from major seismic events or extreme weather-related events.

#### 1.2.2.2 Substandard Bridge and Roadway Design

The Bourne and Sagamore bridges were constructed in the 1930s to standards that are not in use today. Identical in design, each highway bridge provides four 10-foot-wide vehicular travel lanes (two lanes in each direction) with a double yellow centerline, and a single 5-foot-wide sidewalk. A two-foot-wide safety curb is provided along the side opposite the sidewalk.

The aging Bourne and Sagamore bridges do not meet current highway safety standards. Based on their roadway functional classification as limited access highways, the 10-foot-wide travel lanes along both bridges are two feet narrower than the 12-foot lane width standard specified by the American Association of State Highway and Transportation Officials (AASHTO). The bridges also lack physical separation between opposing traffic lanes and lack shoulder accommodation to provide refuge for drivers in the event of a vehicle breakdown, emergency, crash, or other incidents. Since the existing bridges do not have shoulders, stopped or disabled vehicles block one or both lanes of traffic, resulting in lengthy traffic delays and public safety concerns due to delayed emergency response. Narrow lanes without shoulders and the absence of separation between opposing travel lanes result in frequent reports of sideswipe collisions between vehicles travelling in the same and opposite directions. The lack of shoulders presents additional safety concerns for bicyclists and the absence of barrier separation between the traffic lanes and the existing sidewalk on the Bourne and Sagamore bridges presents safety concerns

for all non-motorized bridge users, including pedestrians and bicyclists. The single raised 5-foot-wide shared pedestrian and bicycle sidewalks provided along the Bourne and Sagamore bridges do not conform to current Americans with Disabilities Act (ADA) and MassDOT geometric design standards, which limit mobility and accessibility for people who do not own or have access to motor vehicles for cross-canal trips. Exhibit 1-4 shows existing conditions on the highway bridges.

#### Exhibit 1-4. Vehicular and Pedestrian Traffic Crossing the Bourne Bridge



Currently, the Bourne and Sagamore bridges transition abruptly to connecting surface roads since the surface roads are aligned very close to the canal. The existing right-hand lane in each direction on the Bourne and Sagamore bridges must double as acceleration/deceleration lanes to facilitate vehicles entering and exiting the bridges onto adjoining roadways. A similar situation occurs where the Bourne Bridge ties into the Bourne Rotary with Cape-bound local traffic entering and exiting the rotary, and cross-traffic mixing with bridge-bound and bridge-exiting traffic. Modern highway design guidance, including AASHTO Highway and Bridge Design Specifications<sup>3</sup> and MassDOT design standards, require that entrance and exit ramps include auxiliary lanes for entering and exiting traffic to transition into or out of through traffic safely. There are also no pavement markings within the Bourne Rotary to indicate lane use, which might lead to driver confusion and increased risk of vehicle collisions.

Approaching the Sagamore Bridge from the north, one of the two travel lanes along Route 3 southbound is dropped to allow travelers from Scenic Highway to merge onto Route 3 at Exit 1A, reinstating the second travel lane. This substandard roadway geometry contributes to congestion and delays on Route 3 southbound, especially during peak periods. Immediately south of the Sagamore Bridge, Route 6 Exit 55 (formerly Exit 1C) provides access to Sandwich Road for eastbound travelers via the Mid-Cape Connector and to Cranberry Highway for westbound travelers. The geometry of Route 6 Exit 55 westbound (at Cranberry Highway) does not comply with current MassDOT highway design standards due to short acceleration and deceleration lanes, and steep grades approaching the Sagamore Bridge.

<sup>3</sup> AASHTO, A Policy on Geometric Design of Highways and Streets. 7<sup>th</sup> Edition, 2018.

The Bourne and Sagamore bridges and their approaches feature steep grades of up to six percent. At a six percent grade, the vertical profile of the bridges is steeper than the four- to five-percent maximum grade typical for a limited-access highway. Because of the steep vertical profile of the bridges and their approaches, it is difficult for vehicles, especially large trucks, to maintain speed. This effect, combined with narrow 10-foot-wide lanes and a lack of auxiliary lanes, causes all traffic to slow down in both directions and make abrupt lane changes.

Further, the traffic safety features of the Bourne and Sagamore bridges, including the bridge railing, transitions, approach guardrails, and approach guardrail ends, do not conform to current AASHTO or MassDOT Specifications.

### 1.2.2.3 Peak-Period Congestion and Poor Traffic Operations

Heavy traffic volumes on the Bourne and the Sagamore bridges, coupled with the previously cited substandard roadway conditions, contribute to poor traffic operations during peak travel periods and crash rates that are considerably higher than the statewide average for similar facilities. The Bourne and Sagamore bridges and their approach roadway network within the Program Study Area currently operate at appreciable delay during peak travel periods. Traffic volumes and congestion levels in the vicinity of Cape Cod Canal are typically highest during the summer when there are more visitor trips to Cape Cod and the islands.

The Bourne Bridge is accessed from points north and west via Route 25, which carries three travel lanes per direction, but narrows to two travel lanes approaching the bridge. Heavy traffic volumes merging from the entrance ramp from Belmont Circle combined with steep inclines on the bridge cause congestion on the bridge approach in most peak hours. Route 25 eastbound terminates immediately south of the Bourne Bridge at the Bourne Rotary, which is another source of congestion during peak hours. Difficulty merging into the rotary causes queueing on Route 25 to extend for several miles during some peak hours. Limited capacity and heavy traffic volumes in the Bourne Rotary also causes queueing to extend back onto its other approaches from northbound Route 28, westbound Sandwich Road, and eastbound Trowbridge Road. Queueing on northbound Route 28 often extends approximately one to two miles during peak hours.

The Sagamore Bridge is accessed from points north via Route 3 and from points on Cape Cod via Route 6. In the southbound direction, Route 3 carries two travel lanes toward the Sagamore Bridge and narrows to a single lane as Route 3 approaches the bridge. The single lane from Route 3 is joined by an add lane from the entrance ramp from Scenic Highway (Route 6), to form the two lanes that are carried over the bridge. Congestion stemming from the steep grade and the narrow lanes on the bridge and the lane reduction on Route 3 cause queues to extend back from the bridge approximately one to two miles during peak hours. In the northbound direction, Route 6 carries two travel lanes toward the Sagamore Bridge. A heavy merge from the entrance ramp from Cranberry Highway immediately north of the bridge causes traffic on Route 6 to slow, creating congestion approaching the Sagamore Bridge.

Congestion is measured and tracked through a Level of Service (LOS) mobility measure. LOS is a qualitative measure of driver satisfaction factoring speed, travel time, traffic interruption, freedom of maneuverability, safety, driving comfort and convenience, and delay. LOS is measured using the letters A through F, with A being the best or optimal condition and F being the worst condition. LOS E, unstable flow conditions, and LOS F, forced or breakdown traffic flow, are typically considered deficient traffic operations. LOS A, LOS B, and LOS C are generally considered acceptable conditions; LOS D is generally considered marginally acceptable conditions; and LOS E and LOS F are generally considered unacceptable to most drivers.

The approaches to the Bourne and Sagamore bridges from both directions operate at poor LOS for all peak hours analyzed under 2019 base year conditions including the weekday morning (AM) peak hour (summer and fall), the weekday afternoon (PM) peak hour (summer and fall) and the Saturday midday peak hour (summer and fall). The following locations operate at LOS E, or LOS F during one or more peak hours, consistent with field observations:

- The southbound side of the Bourne Bridge currently operates at LOS F during all peak hours analyzed due to congestion at the Bourne Rotary.
- Southbound Route 25 approaching the exit for Belmont Circle operates at LOS E and F during the summer weekday PM peak hour, fall Saturday midday peak hour and summer Saturday midday peak hour.
- Northbound Route 28 approaching the Bourne Rotary also operates at LOS F during the fall and summer weekday PM peak hours, in addition to fall and summer Saturday midday peak hours.
- Westbound Route 6 and southbound Route 3 approaching the Sagamore Bridge operate at LOS E and F for all peak hours analyzed.
- Both directions of the Sagamore Bridge also operate at LOS F for all peak hours analyzed.

With projected growth in traffic volumes in future years, operating conditions are expected to worsen over time.

The Bourne and Sagamore bridges experienced a substantially higher crash rate than the MassDOT average crash rate for similar principal arterial roadways during the most recently studied period of January 2017 through December 2019. The MassDOT crash rate for a similar facility is 0.80 crashes per million vehicle miles traveled (MVMT). The Bourne Bridge experienced a crash rate of approximately 1.8 crashes per MVMT or 120 percent higher than the State average crash rate for a principal arterial roadway. The Sagamore Bridge experienced a crash rate of approximately 2.6 crashes per MVMT or 228 percent higher than the State average crash rate for a principal arterial roadway.

Observed crashes by type during the 2017 – 2019 study period can be partially attributed to existing traffic congestion and narrow bridge configuration. The composition of observed crashes by type during the study period is summarized in Table 1-1.



**Table 1-1. Crash Data Summary by Type – 2017 to 2019**

Location	Rear-End	Sideswipe - Same Direction	Sideswipe - Opposite Direction	Head-On	Fixed Object/ Single Vehicle Crash	Not Reported	Total
<b>Bourne Bridge</b>	20	6	11	0	8	0	45
	45%	24%	13%	0%	18%	0%	100%
<b>Sagamore Bridge</b>	20	15	6	2	12	1	56
	36%	27%	11%	4%	21%	1%	100%

The most common crash type on the Bourne and Sagamore bridges is a rear-end crash type, representing 45 percent and 36 percent of crashes, respectively. Congestion along the bridges contributes to the high rate of rear-end crashes. The second most common crash type on the Bourne and Sagamore bridges is a sideswipe – same direction crash type, representing 24 percent and 27 percent of crashes, respectively. This crash type, along with the fixed object/single vehicle crash type, can be partially attributed to the narrow 10-foot lanes and lack of roadway shoulders. The sideswipe – opposite direction and head-on crash types also can be partially attributed to the lack of a median or separation of the direction of travel along each bridge.

Within the past several years, other identified locations in the immediate area of the Bourne and Sagamore bridges with a history of high crash rates include Belmont Circle, Bourne Rotary, and the intersections of Route 6A at Route 130 and Scenic Highway at Meetinghouse Lane. These high-crash locations identify crash clusters that rank within the top five percent of the Cape Cod Commission’s planning region.

## 2 Cape Cod Bridges Program Description

### 2.1 Programmatic and Physical Elements of the Program

The Cape Cod Bridges Program consists of the replacement of the Bourne and Sagamore highway bridges over Cape Cod Canal and corresponding reconfiguration of the highway approach networks on each side of the canal to align with the replacement highway bridges. In coordination with FHWA and USACE, MassDOT is designing the replacement of the Bourne and Sagamore highway bridges to meet current MassDOT and FHWA design criteria, AASHTO highway safety standards, Architectural Access Board (AAB) and ADA requirements, and USACE and U.S. Coast Guard navigation requirements.

Sections 2.1.1 through 2.1.5 describe elements of the Cape Cod Bridges Program based on a conceptual/preliminary level of design.

### 2.1.1 Bridge Type

Utilizing the USACE’s MRER/EA Preferred Alternative of In-Kind Bridge Replacement updated to comply with federal and state highway and design safety standards, MassDOT proposes to replace the Bourne and Sagamore replacement highway bridges with parallel, twin tied-arch bridge structures supported on Delta frames with an approximate 700-foot mainline span length. Figures 2-1 and 2-2 show renderings of the proposed replacement bridges from the viewpoints of the Cape Cod Canal and the motor vehicle driver.



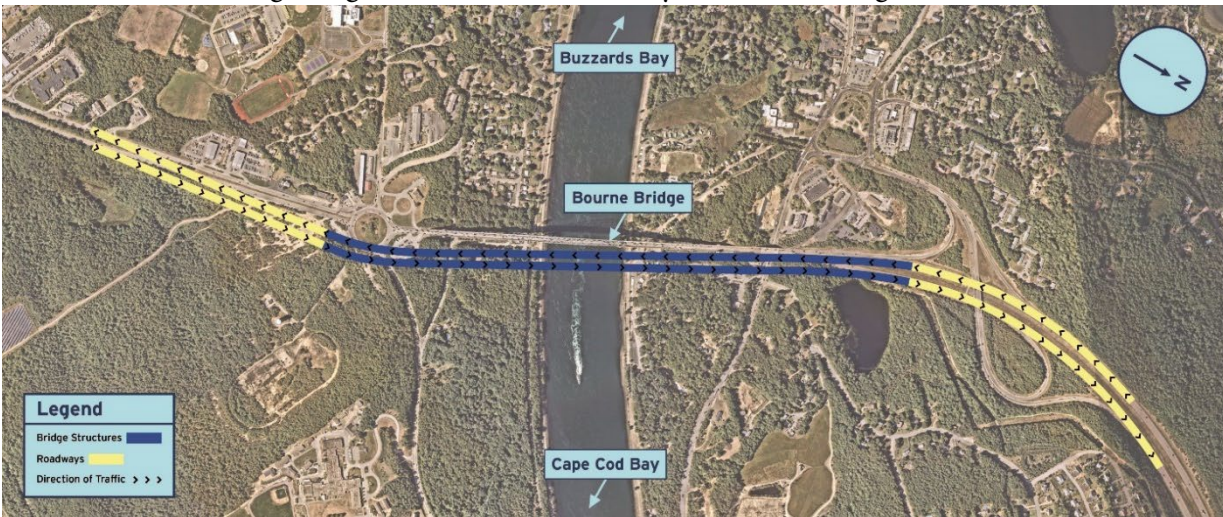
**Figure 2-1. Conceptual Rendering of the Tied-Arch Bridges Preferred Alternative – Cape Cod Canal Viewpoint**



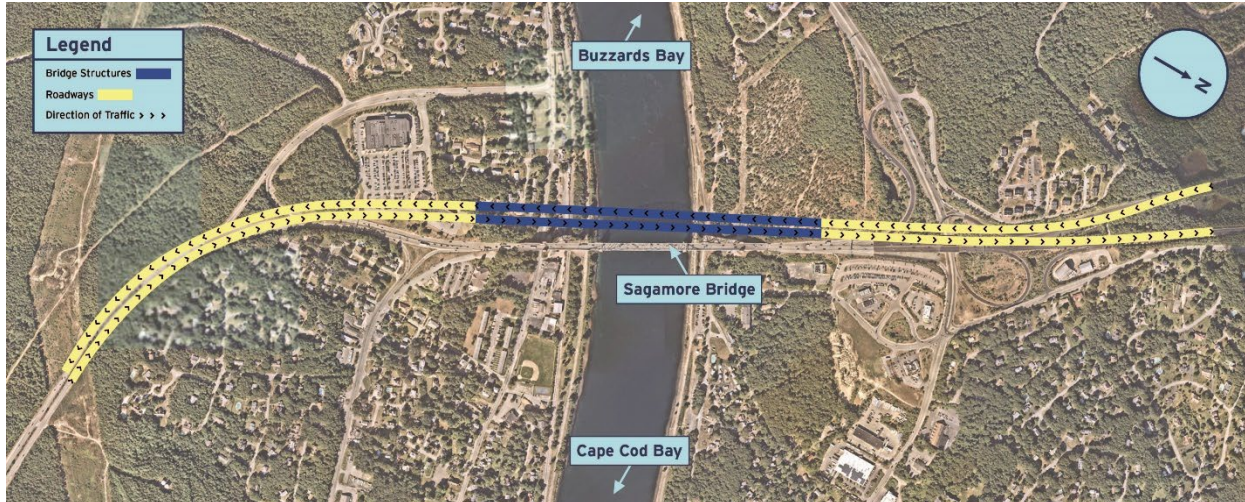
**Figure 2-2. Conceptual Rendering of the Tied-Arch Bridges Preferred Alternative – Driver Viewpoint**

### 2.1.2 Mainline Alignment Location

Both bridges would be replaced in the same general location. For each crossing, the replacement structure would be located fully outside the footprint of the existing bridge and on the side of the canal between the existing Bourne and Sagamore bridge (defined as the “fully offline inboard” mainline alignment location). At the Bourne location, the replacement bridge would be east of the existing bridge, closer to Cape Cod Bay, as shown in Figure 2-3. At the Sagamore location, the replacement bridge would be west of the existing bridge, closer to Buzzards Bay, as shown in Figure 2-4.



**Figure 2-3. Bourne Bridge Replacement Mainline Alignment Location**



**Figure 2-4. Sagamore Bridge Replacement Mainline Alignment Location**

### 2.1.3 Bridge Highway Deck Cross-Section

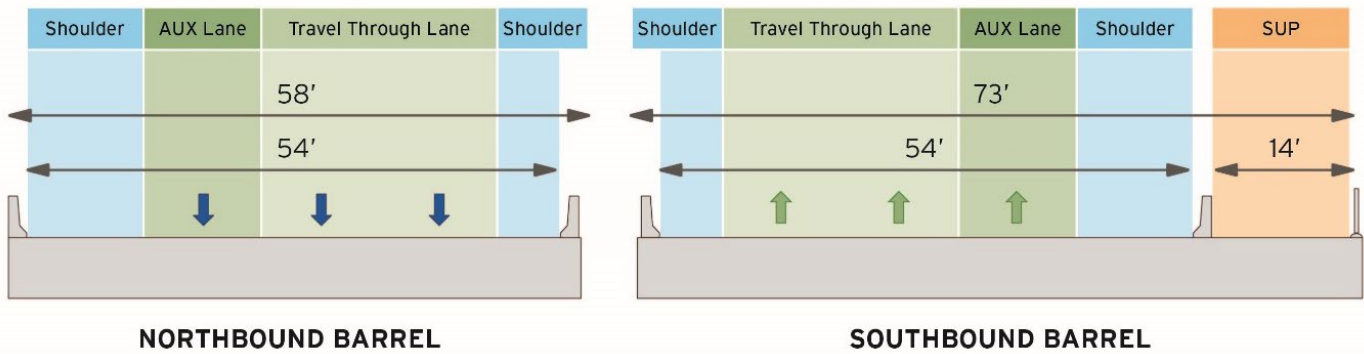
MassDOT is proposing improvements to both the highway bridges and the interchange systems adjacent to each bridge to accommodate replacement of the existing bridges, address future traffic volumes, accommodate multi-modal connections, and construct facilities in compliance with roadway geometric and structural standards. The two parallel bridge structures (barrels) at each crossing would consist of two 12-foot-wide through travel lanes, a 12-foot-wide entrance/exit (auxiliary) lane, a 4-foot-wide left shoulder, and a 10-foot-wide right shoulder. Right and left barriers would be offset an additional 2 feet beyond the limits of the shoulders, for a total structure width of 54 feet curb to curb.

Additionally, each bridge crossing would include one bi-directional pedestrian and bicycle shared use path (SUP), separated from vehicular traffic by the shoulder and barrier. At both the Bourne and Sagamore crossings, the shared use path would be located on the southbound barrel. MassDOT is designing the shared use paths to tie into the existing local bicycle-pedestrian facilities and roadway networks to the maximum extent possible. As design advances, MassDOT will determine the width of the shared use path.

Figure 2-5 shows a schematic of the proposed bridge cross-section at the Bourne and Sagamore crossings with a 14-foot shared use path for illustrative purposes.<sup>4</sup>

---

<sup>4</sup> MassDOT has not determined the total width of the shared use path. A 14-foot-wide shared use path is shown for illustrative purposes only.



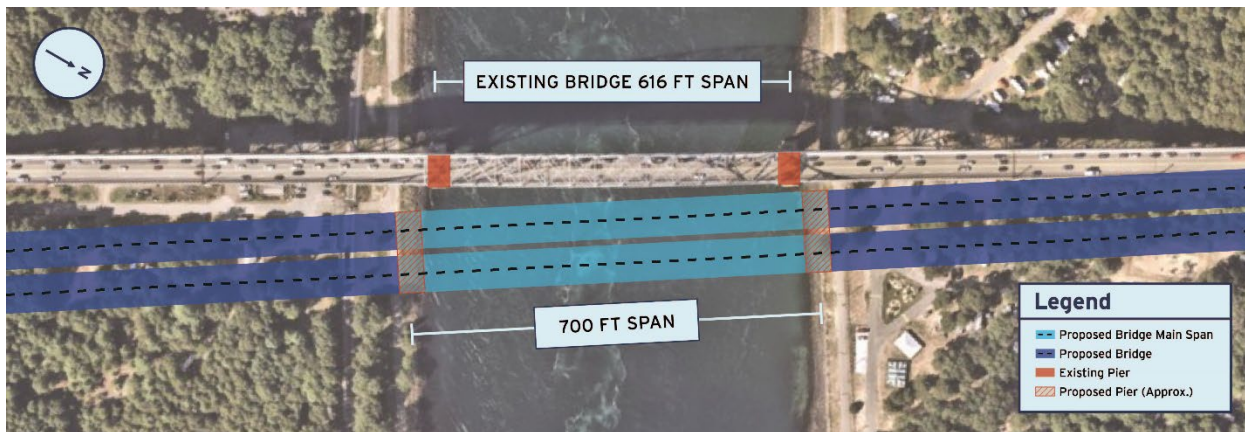
**Figure 2-5. Schematic of Replacement Bridge Structure Cross-Section**

For each crossing, MassDOT proposes to reconfigure the highway approach networks north and south of Cape Cod Canal to align with the replacement highway bridges. The vertical grades of the replacement bridges and their approaches would be reduced from the existing relatively steep 6 percent grade to a maximum grade typical for a limited-access highway. At the Bourne crossing, the approach vertical grade would be 4.5 percent and at the Sagamore crossing, the approach vertical grade would be 4 percent. The flatter roadway and approach grades would improve safety by reducing existing vehicle speed variations and difficulties drivers currently experience during ice and snow events.

#### **2.1.4 Bridge Vertical and Horizontal Clearances**

MassDOT is designing the replacement highway bridges to maintain navigation through Cape Cod Canal, per USACE and USCG requirements. MassDOT is proposing to maintain the existing highway bridges' minimum horizontal clearance of 500 feet and update the vertical clearance of 135 feet above MHW (NAVD88), originally authorized by Congress, to incorporate safety considerations and future sea level rise (SLR).

Supporting an approximate 700-foot mainline span center span, the bridge piers would be in the rip rap slope of Cape Cod Canal and above the low tide line, well outside the navigation channel. Compared to existing conditions, the proposed pier locations would effectively widen the horizontal clearance and improve navigational safety at the bridge sites, as shown in Figure 2-6.



**Figure 2-6. Replacement Bridge Main Span and Pier Location**

To account for future SLR and maintain the existing 135-foot vertical clearance, MassDOT proposes to increase the elevation the bridges by approximately three feet above MHW, for a proposed clearance of 138 feet above MHW (NAVD88). The final bridge navigational clearances will be coordinated with USACE and USCG.

### 2.1.5 Highway Interchange Approach Alternatives

For each crossing, MassDOT proposes to reconfigure the highway interchange approach networks north and south of Cape Cod Canal to align with the replacement highway bridges, including reducing the vertical grades of the replacement bridges and their approaches at each crossing and providing multi-modal (pedestrian and bicycle shared use path) connections with local roadways. Based on conceptual design, MassDOT has identified ten highway interchange approach alternatives, consisting of three alternatives for Bourne North (BN), two alternatives for Bourne South (BS), two alternatives for Sagamore North (SN), and three alternatives for Sagamore South (SS). The alternatives are named according to their general features; each alternative also is identified by the number initially assigned during the Phase I highway interchange approach assessment. The Phase I highway interchange approach assessment is documented in Attachment 4, the Alternatives Analysis Report. Included in the assessment is a summary of the ratings of the alternatives relative to operations, connectivity, geometrics, constructability, and safety; as well as potential impacts regarding utilities, environmental, and right-of-way.

Sections 2.1.5.1 and 2.1.5.2 describe the interchange approach alternative based on conceptual design. Each alternative presented herein includes a schematic showing the proposed layout of the relocated bridge and associated interchange approach network. Pedestrian/bicycle accommodations would include an independent shared use path on the bridge. Proposed paths to the local roadway network will be developed as design advances and will be presented in the DEIR. It is anticipated that connections to local road network would be provided, with direct connections to the USACE Canal Service Roads (bike paths).

### 2.1.5.1 Bourne North Crossing Interchange Approach Alternatives

MassDOT is considering three interchange approach alternatives for the Bourne North (BN) crossing.

#### **1) Northbound On-Ramp Alternative (Alternative BN-6.1)**

The Northbound On-Ramp Alternative largely mimics the existing interchange configuration. All entering and exiting movements utilize existing ramp configurations with minor modifications to meet the proposed offset mainline and to improve acceleration and deceleration distances. Like existing conditions, the termini of the ramps are in the northeast quadrant of Belmont Circle. In addition to maintaining the existing ramp configurations, this alternative adds a second northbound access point from Route 6 (Scenic Highway) to Route 25. Access to this ramp is located along Scenic Highway between the relocated mainline and the existing intersection with Nightingale Road. The new ramp alignment closely follows the relocated mainline alignment before curving east, away from the mainline, to reconnect with the curvature of the existing northbound on/off loop ramp. The new ramp merges with the existing northbound on-ramp before merging with the Route 25 mainline highway. It is anticipated that connections to the local road network would be provided by shared use path direct connections to Belmont Circle and the USACE Canal Service Road (bike path). Figure 2-7 shows a conceptual layout of the Northbound On-Ramp Alternative.





## **2) Single Exit Partial Interchange Alternative (Alternative BN-13.1)**

The Single Exit Partial Interchange Alternative builds upon the concepts introduced in the Northbound On-Ramp Alternative, where all entering and exiting movements utilize existing ramp configurations with minor modifications to meet the proposed offset mainline and to improve acceleration and deceleration distances. This alternative also adds a connection from Route 25 southbound off-ramp directly to Scenic Highway. The new direct connection from Route 25 southbound to Route 6 (Scenic Highway) is possible via a division of the existing southbound off-ramp that continues south parallel to the relocated mainline. This alignment requires the Route 25 southbound off-ramp to pass under the Route 25 southbound on-ramp in a braided ramp configuration. After passing under the southbound on-ramp, the off-ramp continues south until it intersects with Scenic Highway at an at-grade intersection. The Route 25 connection with Scenic Highway eastbound is west of the Nightingale Road intersection and is controlled by a signal. It is anticipated that connections to the local road network would be provided by shared use path direct connections to Belmont Circle and the USACE Canal Service Road (bike path). Figure 2-8 shows a conceptual layout of the Single Exit Partial Interchange Alternative.



Figure 2-8. Bourne North Crossing Interchange Approach - Single Exit Partial Interchange Alternative

### 3) Directional Interchange Alternative (Alternative BN-14.4b)

The Directional Interchange Alternative addresses the high travel demand movements from Route 25 to Route 6 (Scenic Highway) by providing a combination of direct connection ramps. This alternative provides a connection between Route 6 westbound and Route 25 northbound with an exit ramp from Route 6 westbound prior to the Nightingale Road intersection. The ramp passes over Nightingale Road before turning northerly to continue parallel to the relocated Route 25 mainline, like the ramp alignments proposed in the other Bourne North crossing alternatives. The Directional Interchange Alternative provides a connection between Route 25 southbound and Route 6 eastbound with an off-ramp, following a similar alignment to the ramp proposed in the Single Exit Partial Interchange Alternative. However, rather than the ramp terminating at the at-grade intersection proposed in the Single Exit Partial Interchange Alternative, in the Directional Interchange Alternative, the ramp stays elevated and spans over Route 6 while curving easterly. It then crosses under the relocated Route 25 mainline before merging with Route 6 eastbound after the Nightingale Road intersection. All other movements in the Directional Interchange Alternative maintain the existing ramp configurations with termini in the northeast quadrant of Belmont Circle. The two alternatives have many similarities and portions of each option are interchangeable with each other, including the Nightingale Road flyover structure and Route 25 southbound off-ramp flyover or at grade intersection with Scenic Highway. It is anticipated that connections to the local road network would be provided by shared use path direct connections to Belmont Circle, the USACE Canal Service Road (bike path), and Scenic Highway. Figure 2-9 shows a conceptual layout of the Directional Interchange Alternative.

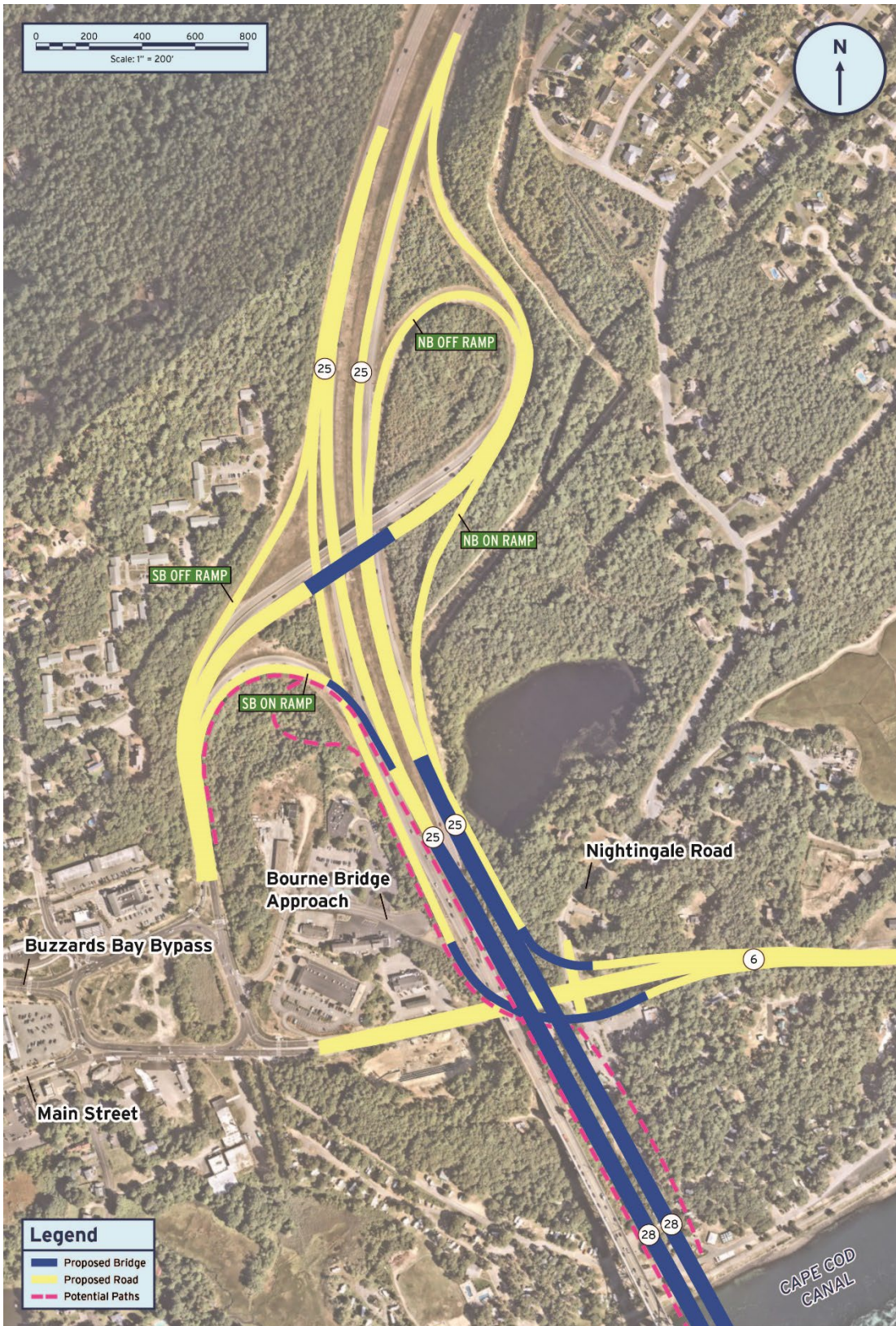


Figure 2-9. Bourne North Crossing Interchange Approach - Directional Interchange Alternative

### 2.1.5.2 Bourne South Crossing Interchange Approach Alternatives

MassDOT is considering two interchange approach alternatives for the Bourne South (BS) crossing.

#### **1) Diamond Interchange Alternative (Alternative BS-2)**

The Diamond Interchange Alternative replaces the existing Bourne Rotary with a grade separated diamond interchange. The relocated Route 25/Route 28 spans over the reconfigured Trowbridge Road. Local connections from Route 25/Route 28 are made via slip ramps connecting to Trowbridge Road. The Diamond Interchange Alternative provides a two-way frontage road west of Route 28 southbound, providing local access to businesses that are currently accessed from existing Route 28 southbound. It is anticipated that connections to the local road network would be provided by shared use path direct connections to Trowbridge Road westbound and the USACE Canal Service Road (bike path). Figure 2-10 shows a conceptual layout of the Diamond Interchange Alternative.



Figure 2-10. Bourne South Crossing Interchange Approach - Diamond Interchange Alternative

## 2) Single-Point Interchange Alternative (Alternative BS-2.2)

The Single-Point Interchange Alternative replaces the existing Bourne Rotary with a grade separated single point urban interchange (SPUI) configuration. Like the Diamond Interchange Alternative, in the Single-Point Interchange Alternative, the relocated Route 25/Route 28 spans over a reconfigured Trowbridge Road. The on and off slip ramps terminate at Trowbridge Road with a central intersection located beneath the relocated Route 25/Route 28 bridge. Like the Diamond Interchange Alternative, the Single-Point Interchange Alternative includes a two-way frontage road west of Route 28 southbound that provides access to local businesses that are currently accessed from existing Route 28 southbound. However, due to the geometry of the turning lanes associated with the central intersection, access to the frontage road from Trowbridge Road may not be feasible. To provide access to this frontage road, a connecting roadway from the southbound on-ramp is provided. It is anticipated that connections to the local road network would be provided by shared use path direct connections to Trowbridge Road westbound and the USACE Canal Service Road (bike path). Figure 2-11 shows a conceptual layout of the Single-Point Interchange Alternative.

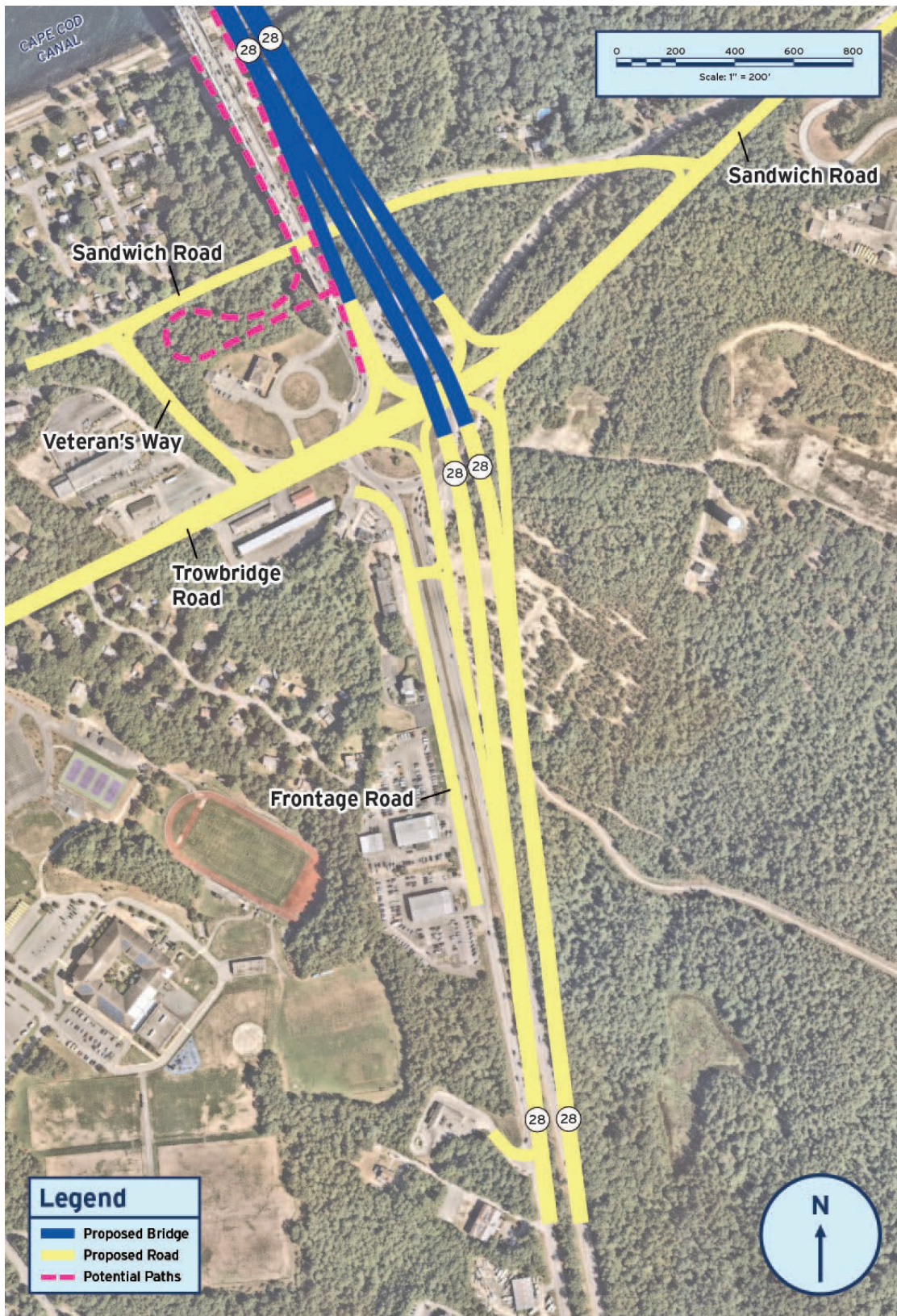


Figure 2-11. Bourne South Crossing Interchange Approach - Single-Point Interchange Alternative

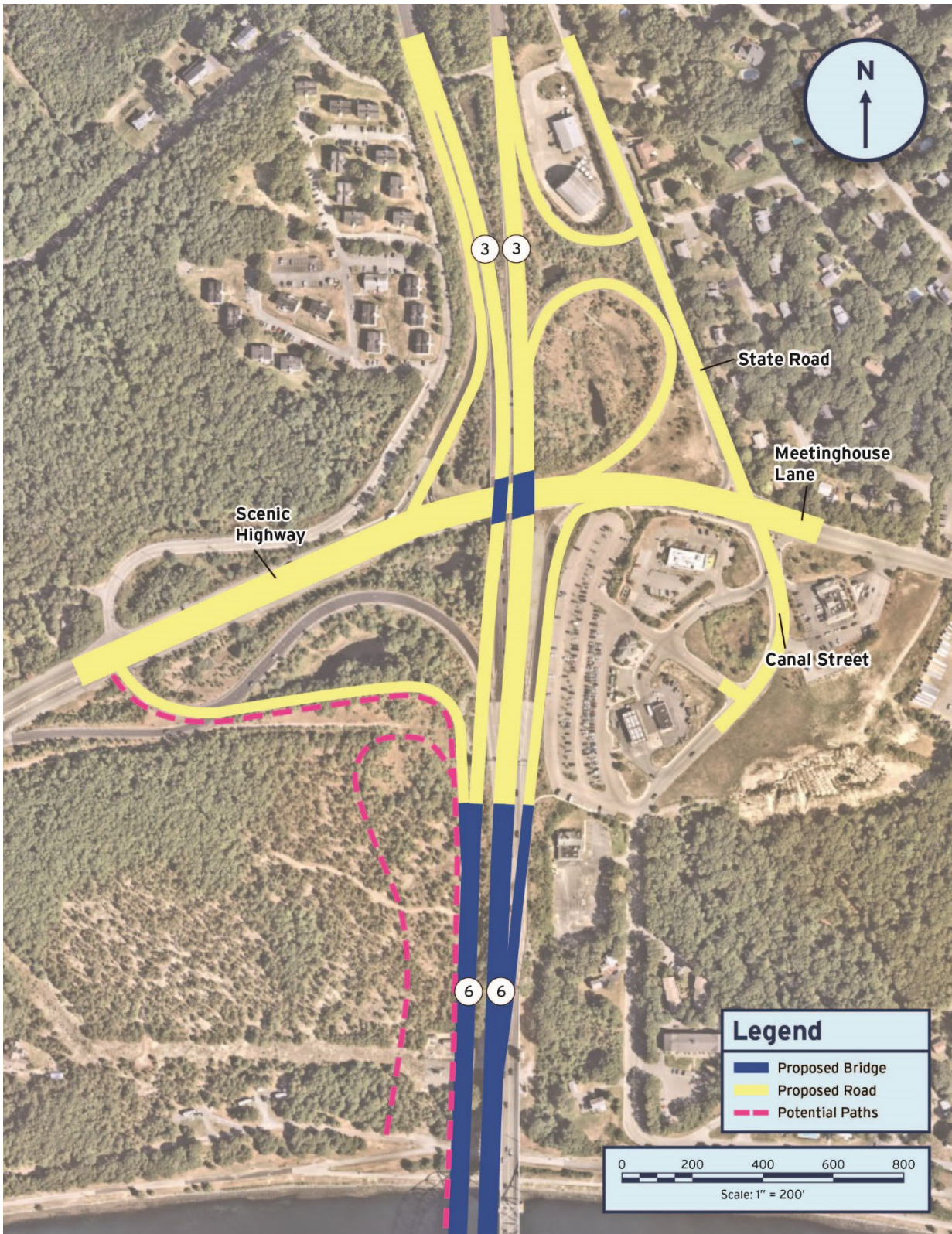


### 2.1.5.3 Sagamore North Crossing Interchange Approach Alternatives

MassDOT is considering two interchange approach alternatives for the Sagamore North (SN) crossing.

#### 1) Similar to Existing Configuration Alternative (Alternative SN-1A)

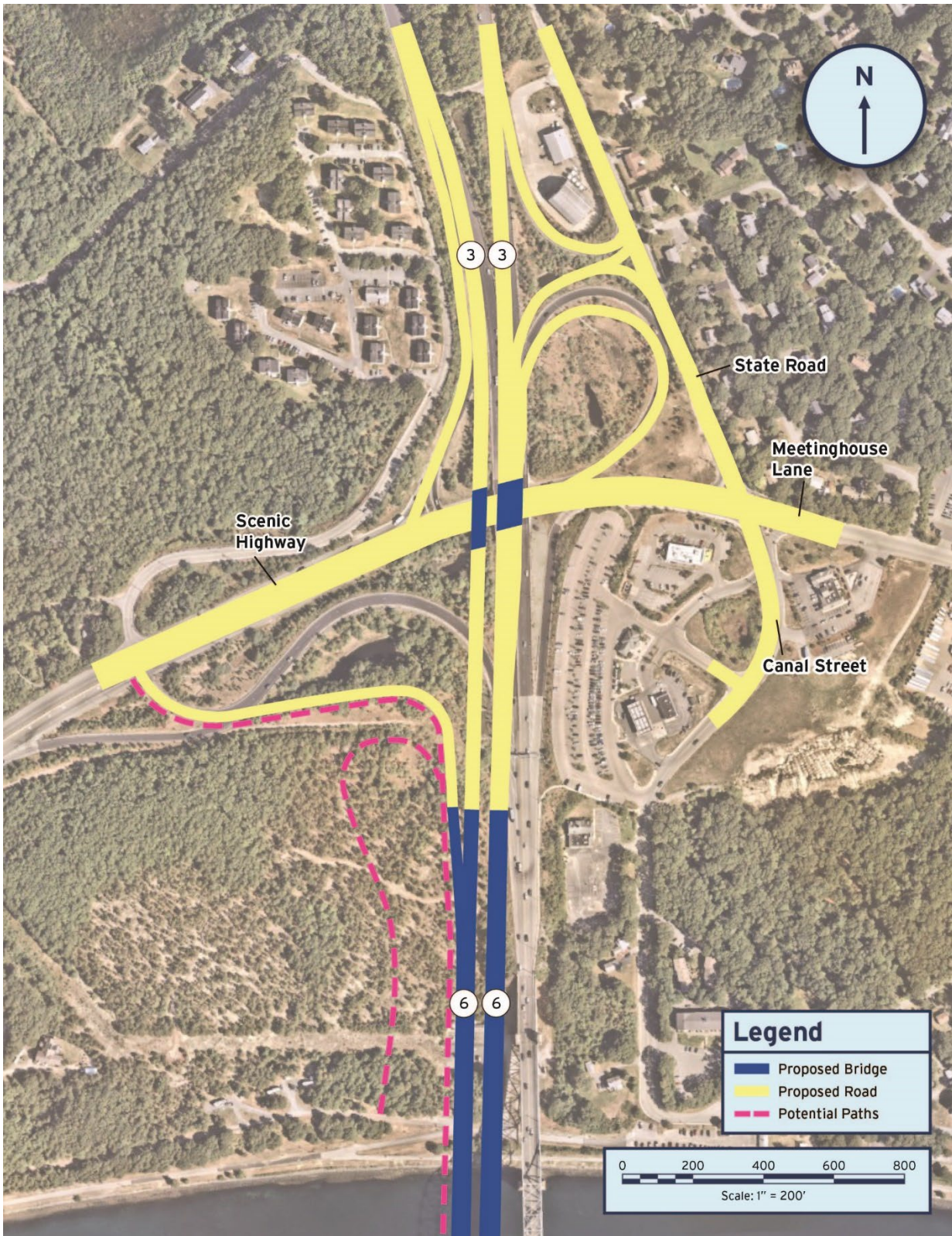
The Similar to Existing Configuration Alternative mimics the existing interchange ramp configurations and includes the modifications necessary to support the relocated Route 3 alignment. In this alternative, acceleration and deceleration lane lengths are increased to meet current design standards and improve user safety and operations. State Road is not modified and there is no change to the Route 6 westbound off-ramp loop to Scenic Highway. It is anticipated that connections to the local road network would be provided by a shared use path connection to the USACE Canal Service Road (bike path). Based on conceptual design, this alternative would not allow for additional bicycle/pedestrian accommodations along State Road without substantial right-of-way impacts. Figure 2-12 shows a conceptual layout of the Similar to Existing Configuration Alternative.



**Figure 2-12. Sagamore North Crossing Interchange Approach - Similar to Existing Configuration Alternative**

## 2) Direct Connection to State Road Alternative (Alternative SN-8A)

The Direct Connection to State Road Alternative is like the configuration of the other Sagamore North crossing alternative. The Direct Connection to State Road Alternative introduces a variation to the existing interchange by providing a single exit point from a relocated Route 3. This alternative relocates the northbound to eastbound off-ramp movement and eliminates the northbound to eastbound slip ramp. Vehicles exiting Route 3 northbound and continuing to State Road or Meetinghouse Lane cross over Scenic Highway/Meetinghouse Lane before turning easterly to connect directly to State Road. In the Direct Connection to State Road Alternative, State Road is widened to the west, which allows for further improvements to the ramp geometry and State Road. It is anticipated that connections to the local road network would be provided by a shared use path connection to the USACE Canal Service Road (bike path) and on the east side of State Road. Figure 2-13 shows a conceptual layout of the Direct Connection to State Road Alternative.



**Figure 2-13. Sagamore North Crossing Interchange Approach - Direct Connection to State Road Alternative**

#### 2.1.5.4 Sagamore South Crossing Interchange Approach Alternatives

MassDOT is considering three interchange approach alternatives for the Sagamore South (SS) crossing.

##### 1) Similar to Existing Configuration with Cranberry Highway Extension Alternative (Alternative SS-1)

The Similar to Existing Configuration with Cranberry Highway Extension Alternative proposes modifications to ramp alignments to accommodate the relocated Route 6 mainline while largely maintaining the existing ramp configurations. The westbound on-ramp and off-ramp movements utilize a diamond type configuration to meet a modified Cranberry Highway. Acceleration and deceleration lanes are lengthened to improve safety and operations along the Route 6 mainline and ramps. The eastbound on-ramp also maintains its existing configuration but features a lengthened acceleration lane to meet current design standards and improve operations and safety. While the eastbound off-ramp maintains the same general configuration as the existing off-ramp, it shifts approximately 400 feet toward the existing infield area to meet the relocated Route 6 roadway. This alternative also extends Cranberry Highway under Route 6 and continues to the intersection with the Mid-Cape Connector. It is anticipated that connections to the local road network would be provided by shared use path direct connections to Cranberry Highway, Sandwich Road and the USACE Canal Service Road, including bicycle and pedestrian accommodations along Cranberry Highway and Cranberry Highway Extension. Figure 2-14 shows a conceptual layout of the Similar to Existing Configuration with Cranberry Highway Extension Alternative.



**Figure 2-14. Sagamore South Crossing Interchange Approach - Similar to Existing Configuration with Cranberry Highway Extension Alternative**

## 2) Similar to Existing Configuration Alternative (Alternative SS-1.1)

The Similar to Existing Configuration Alternative provides the same interchange configuration as the Similar to Existing Configuration with Cranberry Highway Extension Alternative, but this alternative eliminates the Cranberry Highway Extension. This elimination results in an option that largely mimics the existing interchange configuration with modifications limited to those necessary to match the relocated Route 6 mainline and to provide lengthened acceleration and deceleration lanes. It is anticipated that connections to the local road network would be provided by shared use path direct connections to Sandwich Road and the Canal Service Road, including bicycle and pedestrian accommodations along Cranberry Highway. Figure 2-15 shows a conceptual layout of the Similar to Existing Configuration Alternative.



**Figure 2-15. Sagamore South Crossing Interchange Approach - Similar to Existing Configuration Alternative**



### 3) Westbound On-Ramp Under Route 6 Alternative (Alternative SS-3.1A)

The Westbound On-Ramp Under Route 6 Alternative closely resembles the Similar to Existing Configuration with Cranberry Highway Extension Alternative with one major difference. In the Westbound On-Ramp Under Route 6 Alternative, the northbound on-ramp is relocated to begin off the Mid-Cape Connector, so it shares the same entrance point as the southbound on-ramp. From this location, the ramp curves northerly and crosses under Route 6 before merging with the Route 6 northbound roadway. The merge occurs as the northbound on-ramp and Route 6 cross over the Cranberry Highway Extension. It is anticipated that connections to the local road network would be provided by shared use path direct connections to Cranberry Highway, Sandwich Road and the USACE Canal Service Road, including bicycle and pedestrian accommodations along Cranberry Highway and Cranberry Highway Extension. Figure 2-16 shows a conceptual layout of the Westbound On-Ramp Under Route 6 Alternative.



**Figure 2-16. Sagamore South Crossing Interchange Approach - Westbound On-Ramp Under Route 6 Alternative**

### 2.1.5.5 Summary of Highway Interchange Approach Alternatives

Table 2-1 summarizes the highway interchange approach alternatives for the Cape Cod Bridges Program. Sections 3 through 6 present potential Program impacts associated with the ten Bourne and Sagamore highway interchange approach alternatives.

**Table 2-1. Summary of Highway Interchange Approach Alternatives**

Program Study Area	Alternative	Summary Description
Bourne North	Northbound On-Ramp (BN-6.1)	Like the existing interchange configuration, modified to meet the offset mainline while adding a new northbound on-ramp directly from Scenic Highway east of the mainline.
	Single Exit Partial Interchange (BN-13.1)	Builds upon the Northbound On-Ramp Alternative and adds a connection from Route 25 southbound off-ramp directly to Scenic Highway.
	Directional Interchange (BN-14.4b)	Like the Single Exit Partial Interchange Alternative and provides a combination of direct connection ramps between Route 25 and Route 6.
Bourne South	Diamond Interchange (BS-2)	Replaces the existing Bourne Rotary with a grade separated diamond interchange.
	Single-Point Interchange (BS-2.2)	Replaces the existing Bourne Rotary with a grade separated single point interchange configuration.
Sagamore North	Similar to Existing Configuration (SN-1A)	Like the existing interchange ramp configurations with modifications to support the relocated Route 3 alignment.
	Direct Connection to State Road (SN-8A)	Like the Similar to Existing Configuration Alternative but provides a single exit point from a relocated Route 3.
Sagamore South	Similar to Existing Configuration with Cranberry Highway Extension (SS-1)	Modifies ramp alignments to accommodate the relocated Route 6 mainline while largely maintaining the existing ramp configurations. Extends Cranberry Highway under Route 6 to provide a connection to Mid-Cape Connector.
	Similar to Existing Configuration (SS-1.1)	Provides the same interchange configuration as Similar to the Existing Configuration with Cranberry Highway Extension Alternative but eliminates the Cranberry Highway Extension.
	Westbound On-Ramp Under Route 6 (SS-3.1A)	Like the Existing Configuration with Cranberry Highway Extension Alternative but relocates the northbound on-ramp so it shares the same entrance point as the southbound on-ramp off the Mid-Cape Connector.

## 2.2 Program Alternatives Analyses

Multiple analyses have been conducted by the USACE and MassDOT to determine the course of action for addressing the vehicular transportation needs in the Cape Cod Canal area, including the high traffic volumes and traffic congestion associated with the functionally obsolete Bourne and Sagamore Highway bridges and their abutting on- and off-Cape highway approach networks. The Cape Cod Bridges Program Alternatives Analysis Report is provided as Attachment 4. Section 2.2 provides a summary of the Alternatives Analysis Report.

### 2.2.1 U.S. Army Corps of Engineers Alternatives Analysis

As previously cited, the USACE's MRE of the Bourne and Sagamore highway bridges involved a structural engineering risk and reliability analysis of the current structures, and a cost engineering, economic analysis, and environmental evaluation of all feasible alternatives. In addition to a Base Condition of continued maintenance and repair of the bridges as needed, but without major rehabilitation ("Fix as Fails"), the USACE identified eleven initial alternatives, as follows: major rehabilitation of both bridges; replacement of one or both highway bridges with new bridges limited to four through-traffic travel lanes each, or with four through-traffic travel lanes and two auxiliary lanes each, or with more than four through-traffic travel lanes and two auxiliary lanes; replacement of the existing bridges with a new single high-level fixed span highway bridge; construction of a third highway bridge; replacement of one or both existing bridges with highway tunnels; replacement of both bridges with a single tunnel; replacement of one or both bridges with low-level draw spans; replacement of both bridges with low-level causeways; and deauthorization and closure of Cape Cod Canal.

The initial alternatives were evaluated and screened at a conceptual level only to reduce the alternatives to those which would be implementable with respect to likely cost, impacts on the marine and land transportation systems, traffic and environmental impacts, and overall practicability. The USACE advanced three alternatives for further consideration, consisting of the following: the Base Condition, required per NEPA; major rehabilitation, which would replace all obsolete structural, mechanical, and electrical components on both bridges to maintain safety and avoid future postings of bridge weight restrictions; and replacement of one or both highway bridges with new bridges having four through-traffic lanes and two acceleration/deceleration lanes. Each of the alternatives would be within the USACE's existing authority for operation, maintenance, repair, rehabilitation, and replacement of the Cape Cod Canal FNP project features.

The USACE conducted an extensive engineering and economic analysis of the existing highway bridges, their rehabilitation, and alternatives to major rehabilitation. To evaluate the alternatives to major rehabilitation of the two highway bridges, the USACE considered the expected performance, reliability and engineering risk of each alternative and compared the alternatives to the base condition to determine their relative effectiveness, cost and impacts toward the goal of providing safe and reliable long-term vehicular access across Cape Cod Canal. In calculating bridge replacement costs, the USACE considered the following: 1) bridge costs, including new bridge construction costs, associated state highway modifications, real estate interests, and utility relocation costs; 2) traffic management during

bridge replacement, including vehicular and marine traffic management; and 3) future operation, maintenance, and repair costs for the replacement bridges.

Based on a detailed evaluation of costs and benefits of the three feasible alternatives, the USACE cited replacement of both bridges with new bridges that conform to modern highway design standards as the Preferred Alternative. The USACE considered the MRER/EA and resulting FONSI as the first phase in examining the future of the Cape Cod highway bridges; actual bridge type and other design parameters would be developed in the next phase of the Cape Cod Bridges Program. Final design would conform to AASHTO, FHWA, and MassDOT design standards current at that time.

### **2.2.2 MassDOT Phase 1 and Phase 2 Analyses**

Utilizing the USACE's MRER/EA as the foundational document for the Cape Cod Bridges Program, MassDOT's Phase 1 and Phase 2 assessments incorporate the MRER/EA's Preferred Alternative: Replacement of Both Highway Bridges with New Bridges with Four Through-Traffic Lanes and Two Auxiliary Lanes (In-Kind Bridge Replacement, updated to comply with federal and state highway and design safety standards).

In coordination with USACE and FHWA, MassDOT conducted extensive analysis of multiple design parameters for the development of the Cape Cod Bridges Program. In the Phase 1 and Phase 2 assessments, MassDOT evaluated, confirmed, and expanded upon the design parameters identified in the MRER/EA's Preferred Alternative. The Alternatives Assessment provided as Attachment 4 summarizes key Phase 1 and Phase 2 assessments MassDOT has conducted to date for the Cape Cod Bridges Program:

- Phase 1 Bridge Highway Assessments: Highway Cross-Section and Shared Use Path;
- Phase 1 Bridge Assessment: Vertical and Horizontal Clearances;
- Phase 1 and Phase 2 Bridge Assessments: Main Span Length and Bridge Pier Location;
- Phase 1 and Phase 2 Bridge Assessments: Bridge Deck Configuration;
- Phase 1 and Phase 2 Bridge Assessments and Community Review: Bridge Types;
- Mainline Alignment Location Assessment;
- Phase 1 Highway Interchange Approach Assessments.

MassDOT's Phase 1 and Phase 2 assessments consist of qualitative evaluations of Program parameters screened by a set of design criteria established in coordination with FHWA and USACE. For the Phase 1 and Phase 2 bridge assessments, no distinction is made between the Bourne and Sagamore crossings; the assessments made at this conceptual and preliminary level of design apply to both replacement bridges. Additionally, MassDOT qualitatively evaluated mainline alignment locations for each bridge crossing. The Phase 1 highway interchange approach assessments consist of evaluations for the two bridge crossings, further broken down by off-Cape alternatives (Bourne North and Sagamore North) and on-Cape alternatives (Bourne South and Sagamore South).

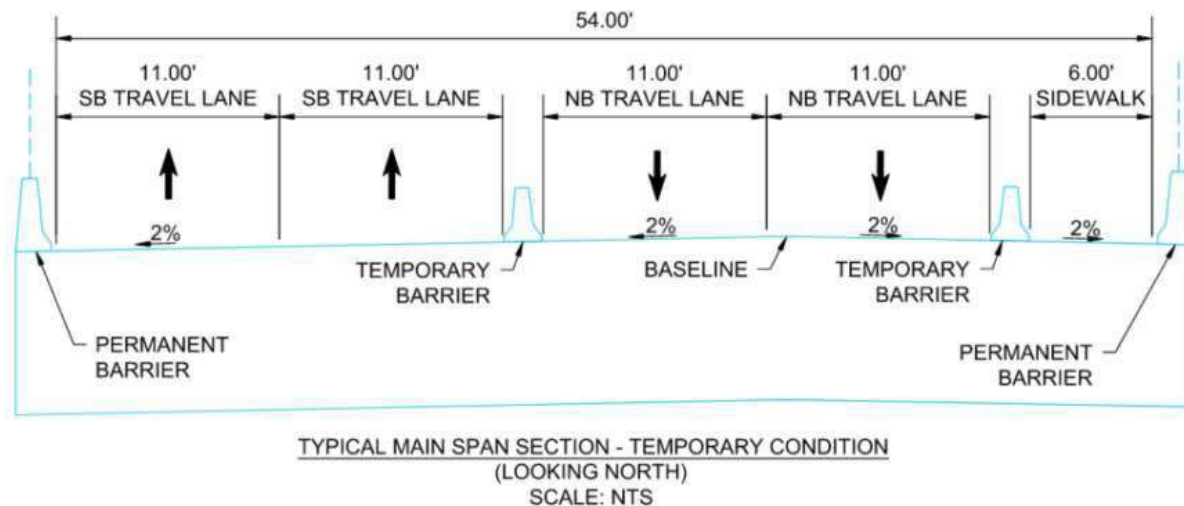
As design advances, MassDOT will conduct the Phase 2 highway interchange approach alternatives analysis. The results of the Phase 2 analysis and identification of the Preferred Alternative for the highway interchange approaches at the bridge crossings (consisting of a pair of alternatives for each crossing) will be reported in the Draft Environmental Impact Report (DEIR).

### 2.3 Program Conceptual Construction Phasing

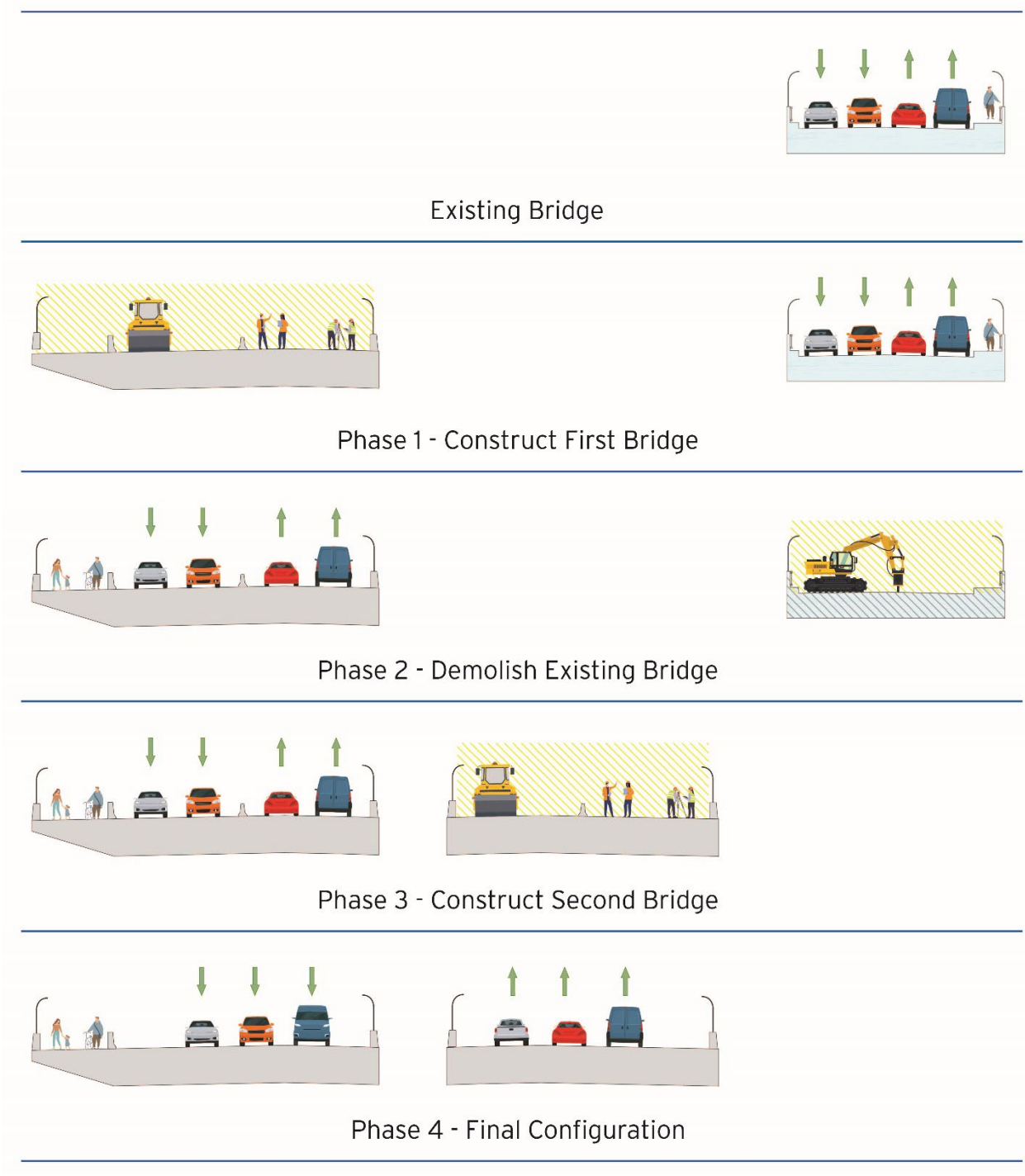
MassDOT is designing the infrastructure elements of Cape Cod Brides Program to maximize constructability. The objectives of the construction phasing plan are to maintain two traffic lanes in each direction at each crossing, maintain all connections to the local roadway network, reduce construction duration and costs, and minimize impacts on the traveling public during construction.

The same construction staging plan would be used for both locations. At each crossing, one replacement highway bridge span (barrel) would be erected first and carry two-way traffic in a temporary configuration, providing the same number of vehicular travel lanes as the existing highway bridge. During this construction phase, the first replacement bridge span would accommodate four 11-foot-wide temporary travel lanes of barrier separated bi-directional traffic and a temporary 6-foot-wide barrier protected sidewalk for bicyclists and pedestrians, as shown on Figure 2-17. The next phases would involve demolishing the existing bridge and constructing the second barrel of the replacement bridge. The last phases would involve routing traffic onto the separate highway bridge structures and reconfiguring the first highway bridge span for one-way traffic.

Figure 2-18 presents a schematic of the construction phasing approach for the replacement bridges. MassDOT will present the proposed construction phasing plans for the four interchange approaches for the Bourne and Sagamore crossings in the DEIR.



**Figure 2-17. Proposed Bridge Replacement Temporary Traffic Configuration**



**Figure 2-18. Schematic of Proposed Bridge Replacement Construction Phasing Approach**

## 3 Land Section

This section describes existing land uses, including protected open space and environmentally impacted land uses, and presents potential impacts of the Program based on conceptual design.

### 3.1 Existing Conditions

#### 3.1.1 Land Use Overview

The Bourne and Sagamore Program Study Areas consist of a variety of land uses, as shown in Figures 3-1 through 3-4.

The Bourne Program Study Area is in the Buzzards Bay community of Bourne, which is characterized by medium to high density residential development and commercial development. North of Cape Cod Canal (Bourne North; Figure 3-1), land uses along Route 25 consist of forested areas, the Nightingale Pond, and natural areas, interspersed with protected land uses, described in Section 3.1.2. Commercial development is centered around Belmont Circle, which includes retail businesses and restaurants with direct access to Belmont Circle, and the Main Street commercial area. South of the canal (Bourne South; Figure 3-2), land uses include higher-density residential and commercial development. Land uses adjacent to the Bourne Rotary include a restaurant and retail establishments, also with direct access to the rotary. The Massachusetts State Police barracks is adjacent to the northwest side of the Bourne Rotary. Extending south from the Bourne Rotary, Route 28 is bordered to the west by the Bourne High School, flanked on both sides by commercial development; and to the area east by portions of the Massachusetts Military Reservation (MMR; Camp Edwards), on Joint Base Cape Cod (JBCC), an approximate 21,000-acre joint-use base which is home to five military commands.

The Sagamore Program Study Area is in the Sagamore Beach and Sagamore communities of Bourne. North of Cape Cod Canal (Sagamore North; Figure 3-3), land uses east and west of Route 3 consist of medium-density residential development, with commercial development located primarily around the Canal Road and Meetinghouse Road intersection. South of the canal (Sagamore South; Figure 3-4), large commercial developments are interspersed among low-density residential development east of the Mid-Cape Connector to Cranberry Highway. Extending south on Route 6 from the Sagamore Bridge, land uses include a portion of the Camp Edwards Wildlife Management Area (part of JBCC) to the west of Route 6 and to the east of Route 6, medium-density residential development and a portion of the 624-acre Shawme-Crowell State Forest.



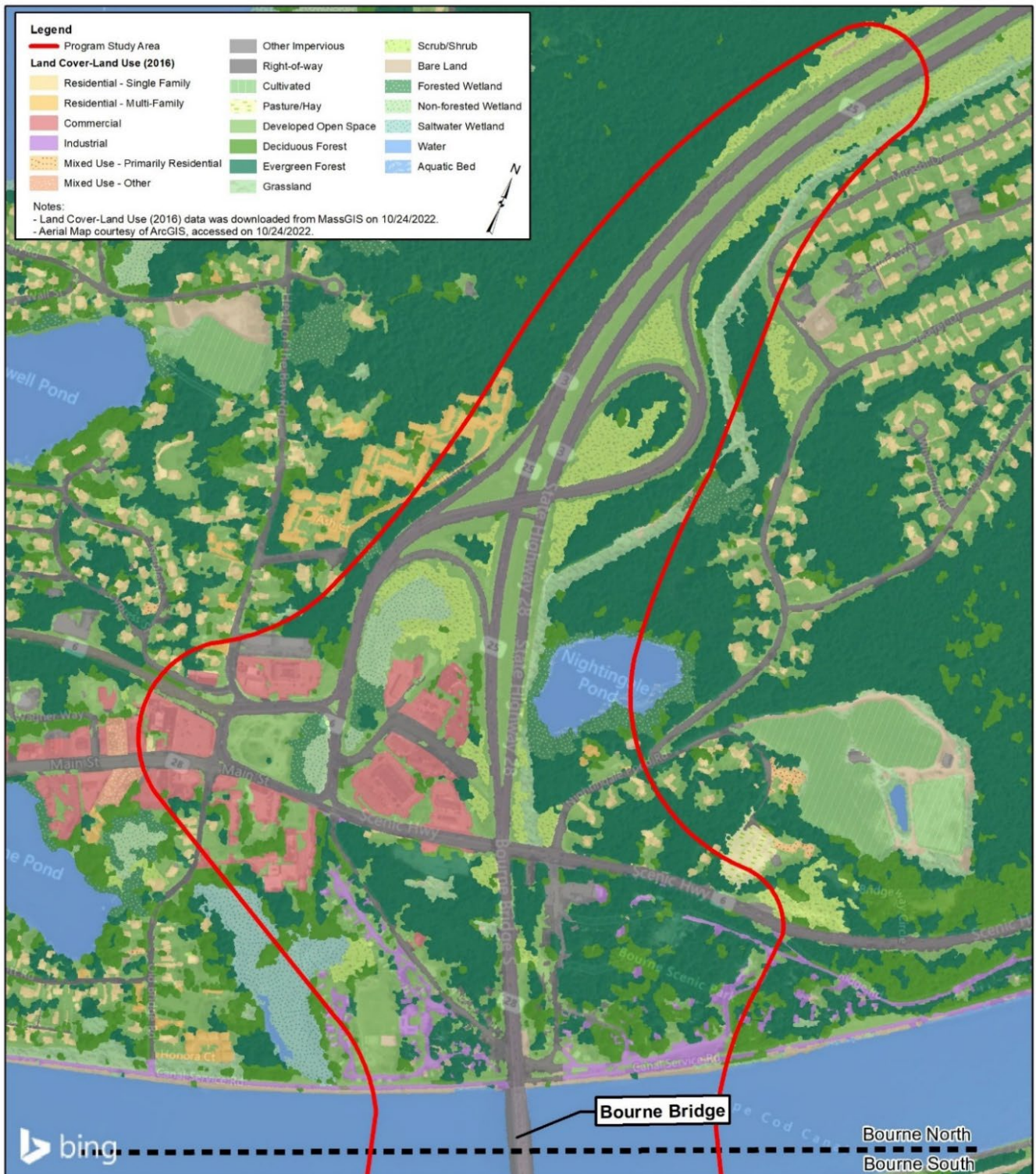
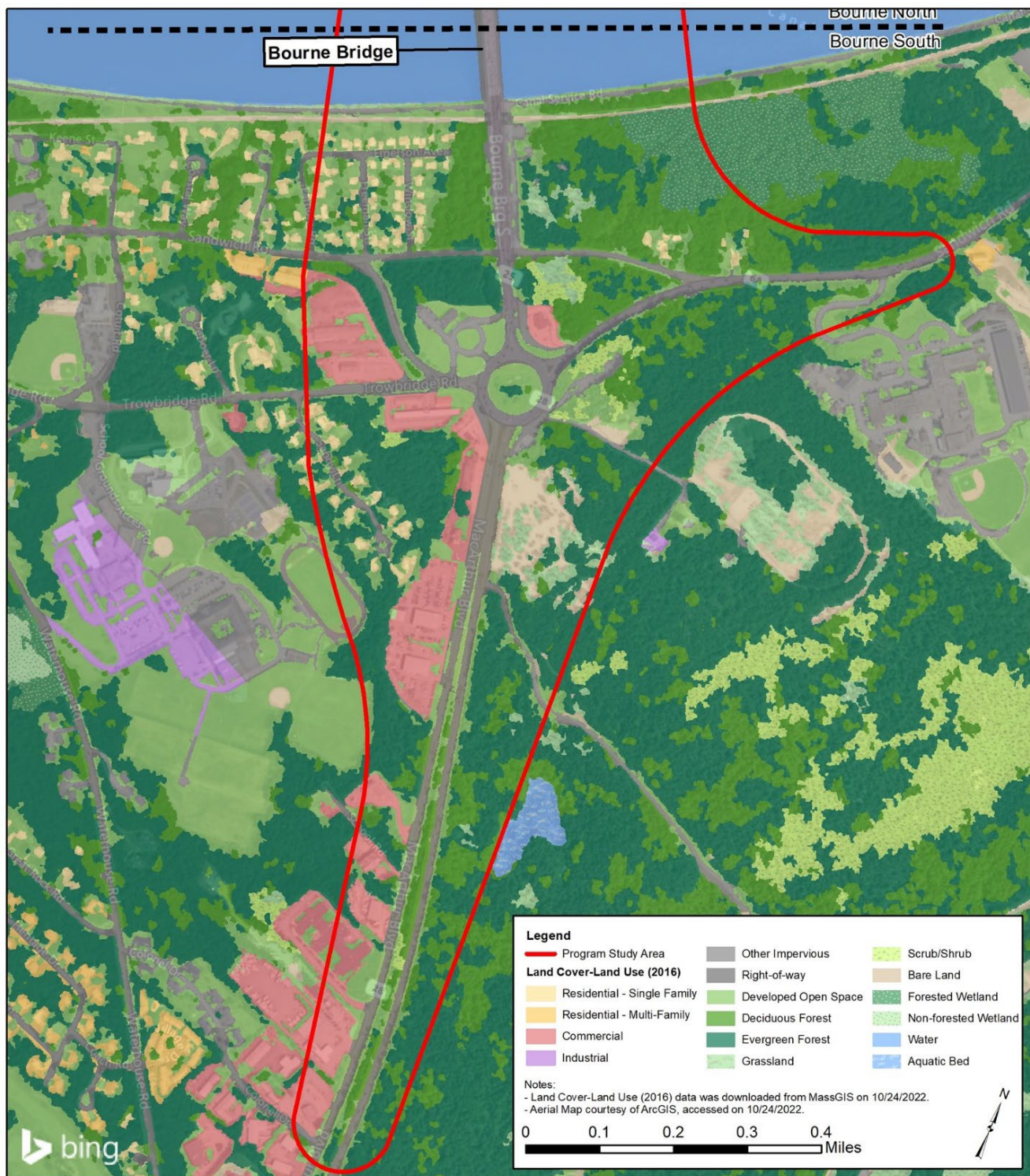


Figure 3-1. Existing Land Uses in the Bourne North Program Study Area



**Figure 3-2. Existing Land Uses in the Bourne South Program Study Area**

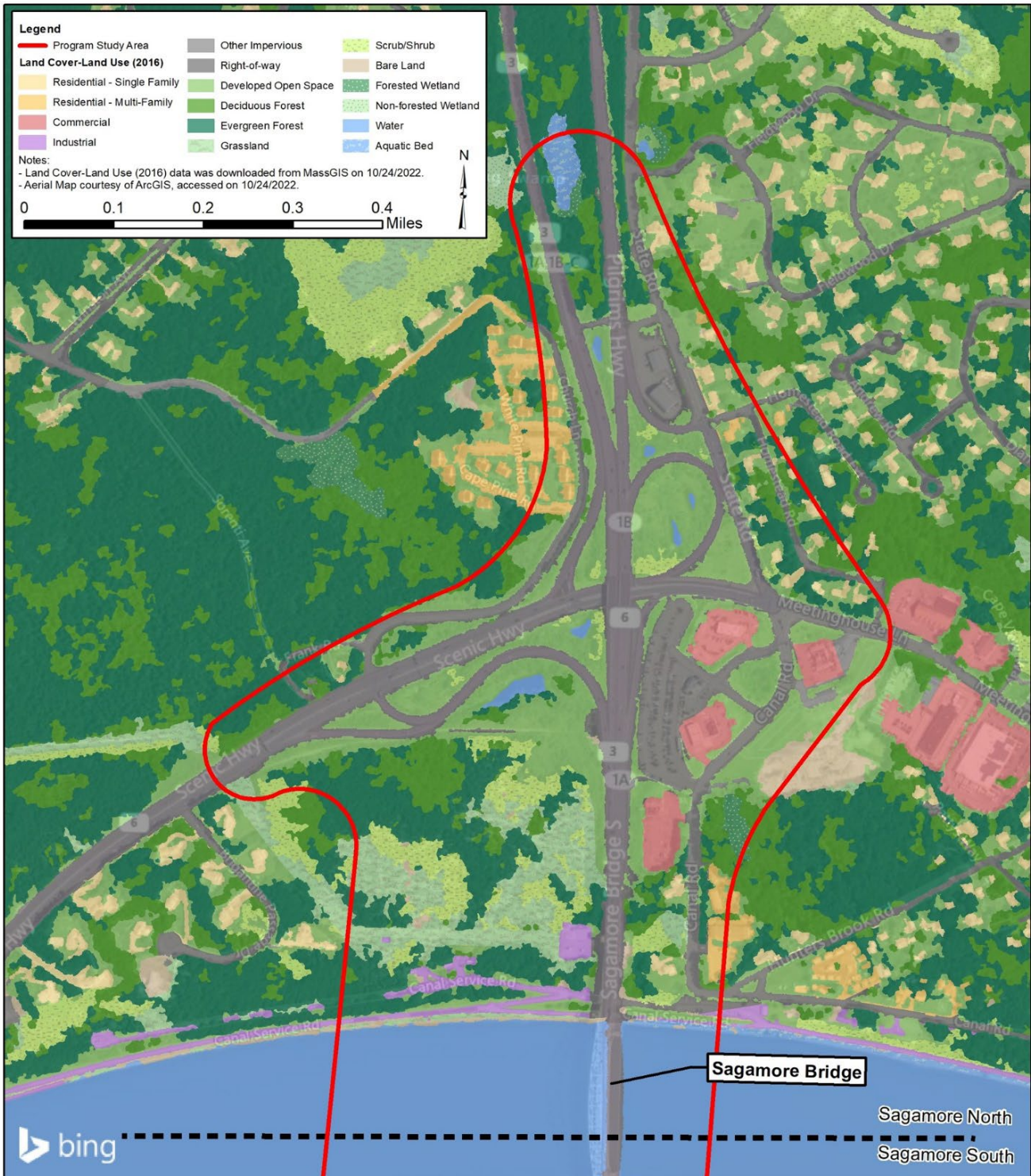
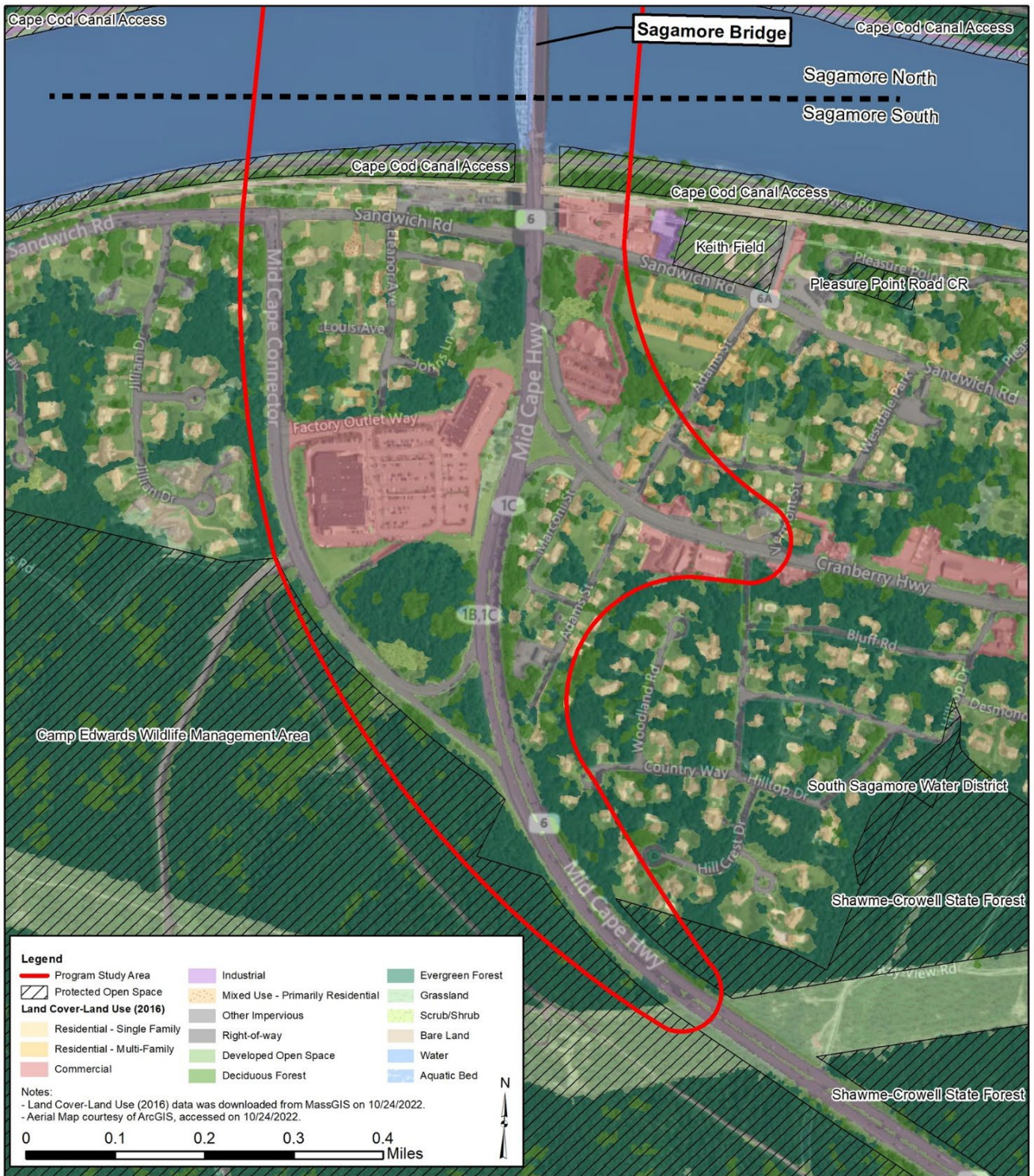


Figure 3-3. Existing Land Uses in the Sagamore North Program Study Area



**Figure 3-4. Existing Land Uses in the Sagamore South Program Study Area**

### 3.1.2 Protected Land Use

The Program Study Areas feature multiple publicly owned and designated protected open space parcels, as shown in Figures 3-5 through 3-8. Protected land uses include federally owned and managed property; Town of Bourne-owned property; and lands acquired by State agencies under the Massachusetts Executive Office of Energy and Environmental Affairs (MA EEA) in fee simple or by a Conservation Restriction.

Article 97 of the Amendments to the Massachusetts Constitution protects publicly owned lands used for conservation or recreation purposes. The goal of MA EEA's Article 97 Land Disposition Policy (February 19, 1998) is to ensure a no net loss of Article 97 lands under the ownership and control of the Commonwealth and its political subdivisions, unless a determination of "exceptional circumstances" is made, including a two-thirds vote of the State Legislature in support of the disposition.

#### 3.1.2.1 Cape Cod Canal Federal Navigation Project

As components of the Cape Cod Canal Federal Navigation Project (FNP), the Bourne and Sagamore highway bridges are located on federally owned and USACE-managed property. The USACE designation of the property is for operation and maintenance of the FNP, which includes the canal, highway bridges, two paved service roads on both sides of the canal, and a vertical lift railroad bridge at Buzzards Bay. However, most of the land surrounding the navigation channel at and near the bridge sites consists of land managed or leased by the USACE for recreation. In the Bourne Program Study Area, these recreation lands include the Bourne Recreation Area, immediately southeast of the Bourne crossing; Bourne Bridge Area beneath the Bourne Bridge; and the 112-acre Bourne Scenic Park, northeast of the Bourne Bridge on Route 6, leased to the Bourne Recreation Authority for camping. In the Sagamore Program Study Area, these recreation lands include the Sagamore Recreation Area, immediately northeast of the Sagamore crossing; and the Sagamore Bridge Area adjacent to the Sagamore Bridge Rotary.

#### 3.1.2.2 Herring River Watershed Area of Critical Environmental Concern

The Herring River Watershed Area of Critical Environmental Concern (ACEC), a 4,450-acre area comprised of open space, lakes and ponds, freshwater wetlands, and cranberry bogs, is located north of the Sagamore Bridge and west of Route 3. Approximately 28 acres of the ACEC is within the Sagamore Program Study Area, representing approximately 9.9 percent of the Study Area.

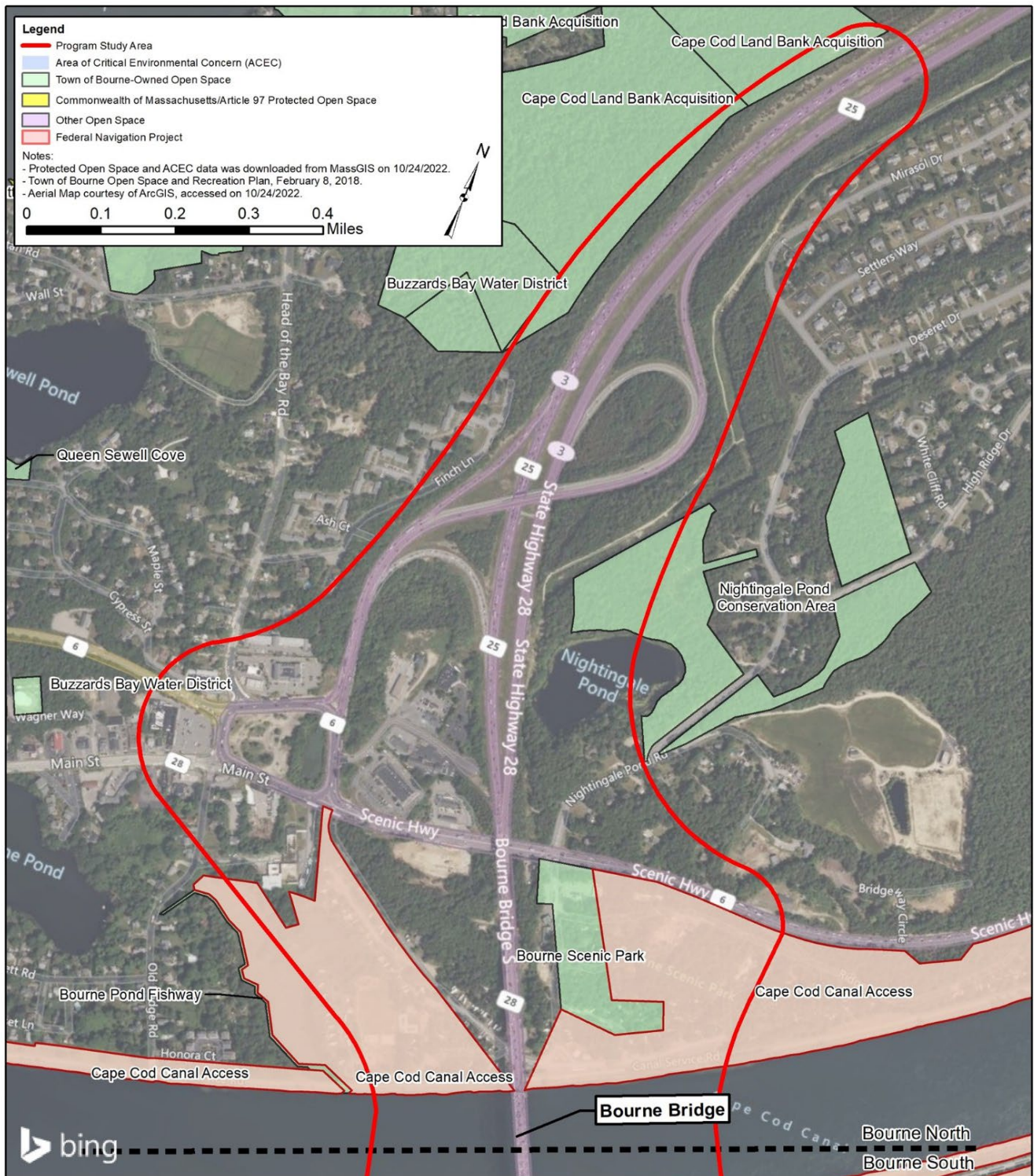
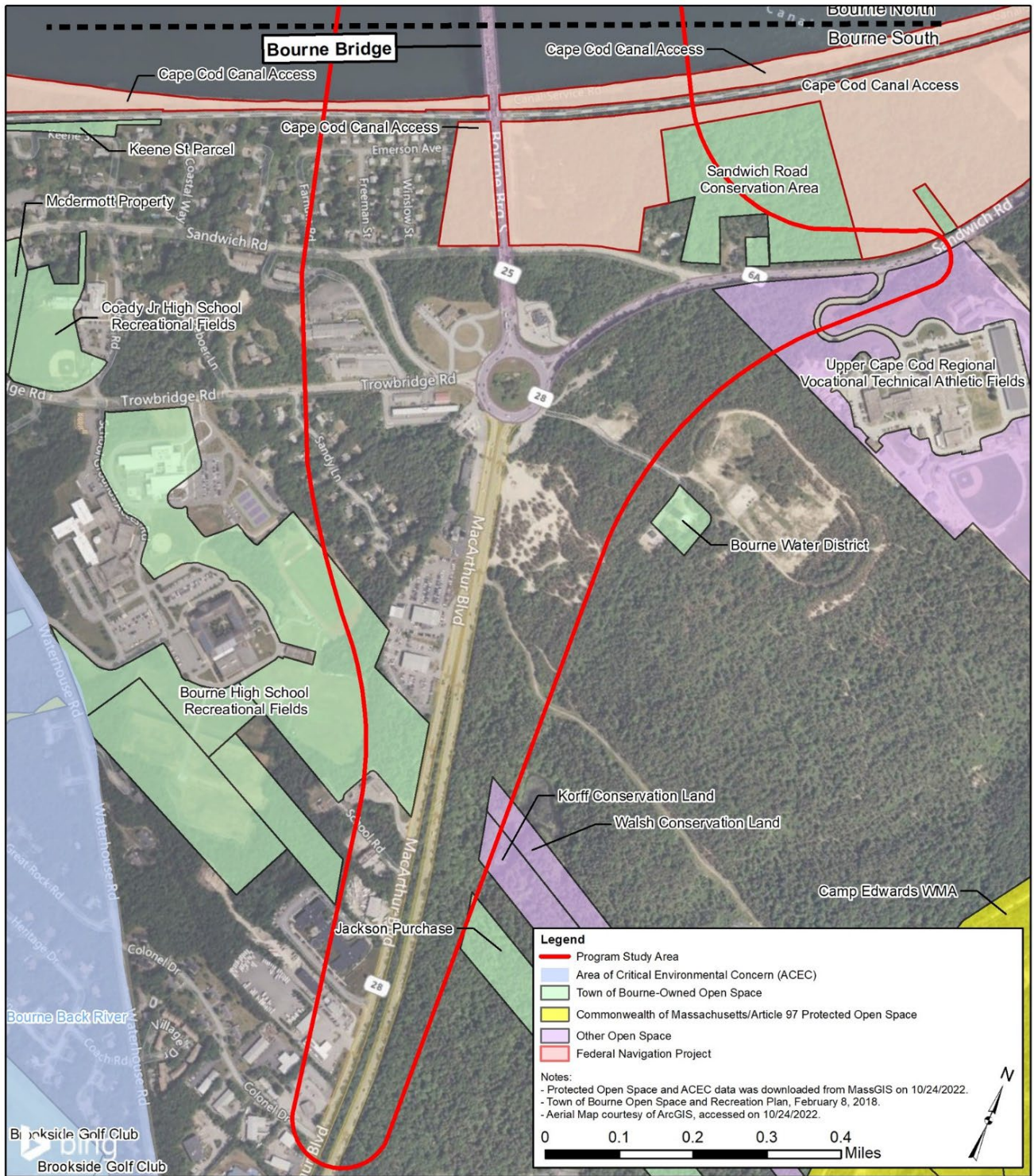
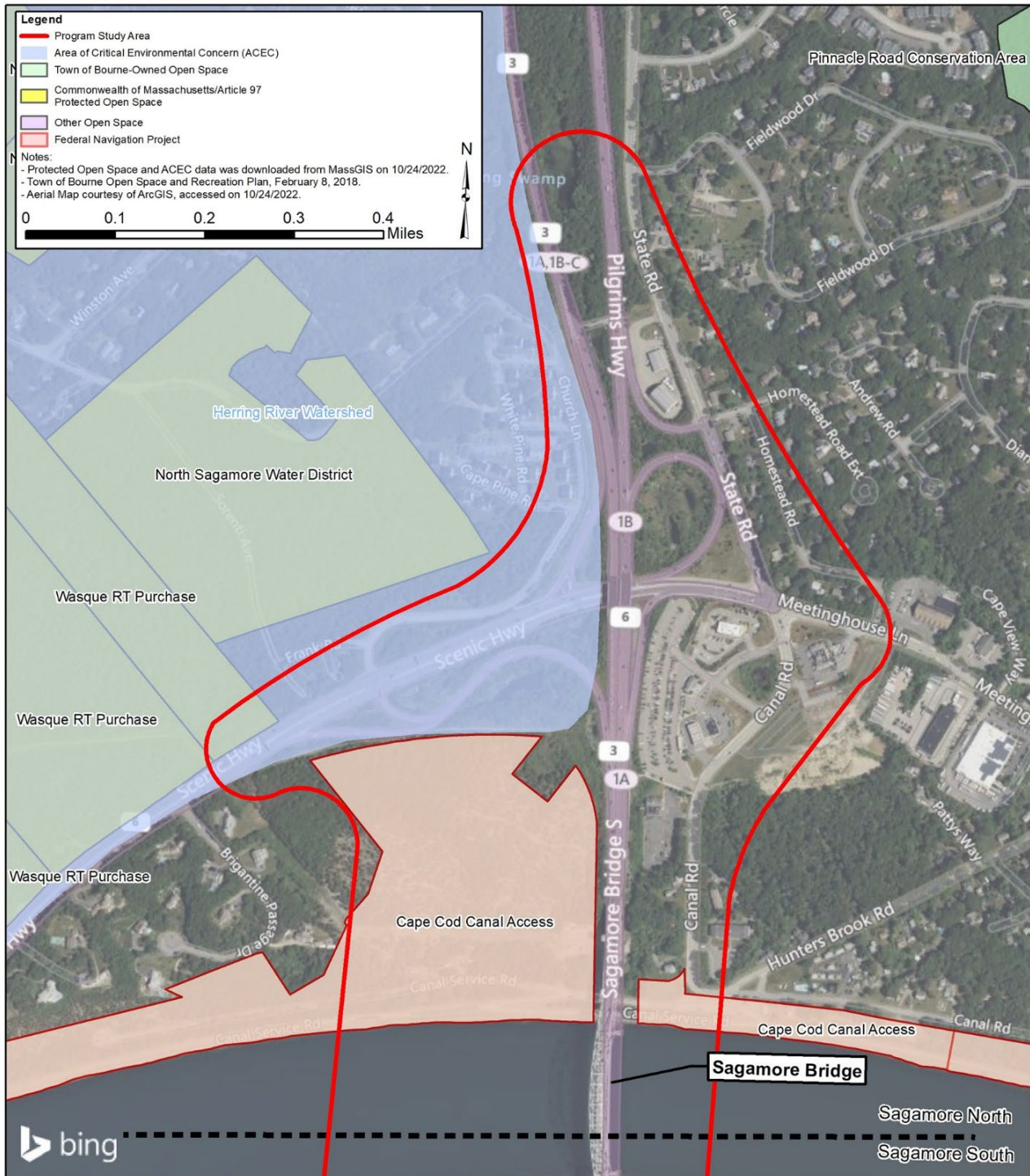


Figure 3-5. Protected Open Space in the Bourne North Program Study Area

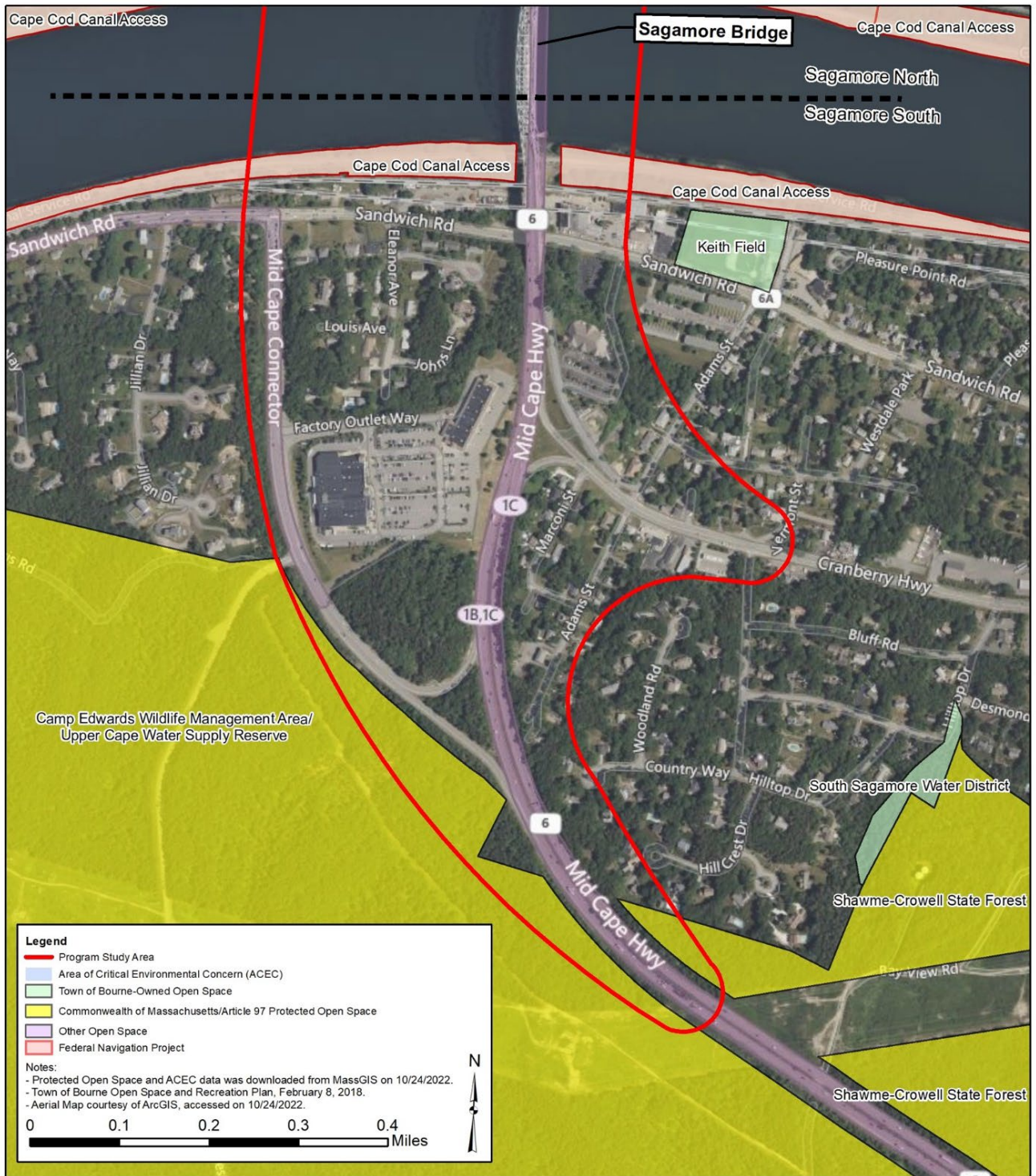


**Figure 3-6. Protected Open Space in the Bourne South Program Study Area**



**Figure 3-7. Protected Open Space in the Sagamore North Program Study Area**





**Figure 3-8. Protected Open Space in the Sagamore South Program Study Area**

### 3.1.2.3 Upper Cape Water Supply Reserve/Camp Edwards Wildlife Management Area

Approximately nine acres of the Upper Cape Water Supply Reserve, located south of the canal between Route 28 and Route 6, overlaps the Sagamore Program Study Area, representing approximately 3.2 percent of the Study Area. The Reserve consists of the northern 15,000 acres of the Massachusetts Military Reservation (MMR; Camp Edwards Training Area) on JBCC; it sits atop the Cape Cod Aquifer, a sole source aquifer that is the source of drinking water for Upper Cape Cod. Owned by the Commonwealth, the Massachusetts Department of Fisheries, Wildlife, and Environmental Law Enforcement, Division of Fisheries and Wildlife is responsible for the care and control of the Reserve. Further, the property is protected as Article 97 lands.

Coterminous with the Upper Cape Water Supply Reserve in the South Sagamore Program Study Area is the Camp Edwards Wildlife Management Area (WMA). This tract of land is the largest piece of undeveloped land on Cape Cod and is home to 37 state-listed species. In general, the WMA is not accessible by the public; however, sections of the WMA are open to the public for deer hunting in the fall and turkey hunting in the spring for limited periods.

Managed under a 2001 Memorandum of Agreement between the Commonwealth of Massachusetts and the U.S. Army and Natural Guard Bureau, the Upper Cape Water Supply Reserve/Camp Edwards WMA is dedicated to three primary purposes: water supply and wildlife habitat protection; development and construction of public water supply systems, and use and training of the military forces of the Commonwealth provided that the military and training use is compatible with the natural resource purposes of water supply and wildlife habitat protection.

### 3.1.2.4 Shawme-Crowell State Forest

The 700-acre Shawme-Crowell State Forest, which is managed by Massachusetts Department of Conservation and Recreation (DCR) and protected as Article 97 lands, is in the Sagamore South Program Study Area. Approximately 1.19 acre of the Shawme-Crowell State Forest is within the Sagamore Program Study Area, representing 0.42 percent of the Study Area. The State Forest is accessible to the public for camping and hiking, with active and passive recreation facilities.

### 3.1.2.5 Bourne Scenic Park

The 88-acre Bourne Scenic Park owned by the Town of Bourne contains camp sites and active recreational facilities located wholly within the Bourne North Program Study Area. It abuts the 112-acre Bourne Scenic Park leased by the USACE to the Town of Bourne. The Bourne Recreation Authority manages the entire 200-acre area.

### 3.1.2.6 Other Town of Bourne Recreation and Conservation Areas

In addition to the Bourne Scenic Park, other Town of Bourne-owned protected open space in the Bourne Program Study Area includes the following areas:

- Portions of two Cape Cod Land Bank parcels, managed by the Bourne Conservation Commission, along Route 3 north; these areas total 6.39 acres, representing 1.4 percent of the Bourne Program Study Area;

- A portion of a parcel owned by the Buzzards Bay Water District along Route 3 north, totaling 0.02 acres and representing a fraction of the Bourne Program Study Area;
- 4.43 acres of the 23-acre Nightingale Pond Conservation Area, east of Route 28; managed by the Bourne Conservation Commission, this area represents slightly less than one percent of the Bourne Program Study Area;
- 6.79 acres of the 15-acre Sandwich Road Conservation Area, east of Route 25 and north of Sandwich Road; managed by the Bourne Conservation Commission, the area represents almost 1.5 percent of the Bourne Program Study Area;
- 5.79 acres of the Bourne High School recreational fields, along Route 28; this area represents 1.3 percent of the Bourne Program Study Area;
- A portion of the Jackson Purchase, a land bank parcel directly east of Route 28; this 0.05-acre area represents a fraction of the Bourne Program Study Area.

According to the Town of Bourne *Open Space and Recreation Plan*, all the municipally owned open space in the Bourne Program Study Area is accessible to the public.<sup>5</sup>

### 3.1.2.7 Other Open Space

Other open space in the Bourne South Program Study Area includes portions of the Upper Cape Cod Regional Technical School, northwest of the Bourne Rotary, abutting Sandwich Road to the south; and portions of two parcels directly east of Route 28 owned by the Bourne Conservation Trust, the Korff Conservation Land and the Walsh Conservation Land. According to the Bourne Open Space and Recreation Plan, because these lands are owned by a non-profit agency dedicated to land conservation, they are considered “protected.”

## 3.2 Environmentally Impacted Land Uses

Figure 3-9 shows existing environmentally impacted land uses in and near the Program Study Areas. No portion of Program Study Areas is currently or has been regulated under the Massachusetts Contingency Plan (MCP). A Tier II site exists just outside the boundaries of the Sagamore Program Study Area south of the canal. An EPA-regulated hazardous waste site, CVS 1576, is located just west of the Route 25 southbound off-ramp within the Bourne Program Study Area. Portions of the Sagamore South Program Study Area are within the boundaries of the U.S. Army National Guard’s Impact Area Groundwater Study Program (IAGWSP). The IAGWSP is investigating and remediating groundwater contamination and its sources in the northern 15,000 acres of Camp Edwards. Within and immediately adjacent to the Sagamore Program Study Area, the boundaries of the IAGWSP are coterminous with the boundaries of the Upper Cape Water Supply Reserve and the Camp Edwards Wildlife Management Area.

---

<sup>5</sup> Town of Bourne *Open Space and Recreation Plan*. Prepared for the Bourne Open Space Committee. Prepared by Worsley Witten Group, Inc. February 8, 2018.

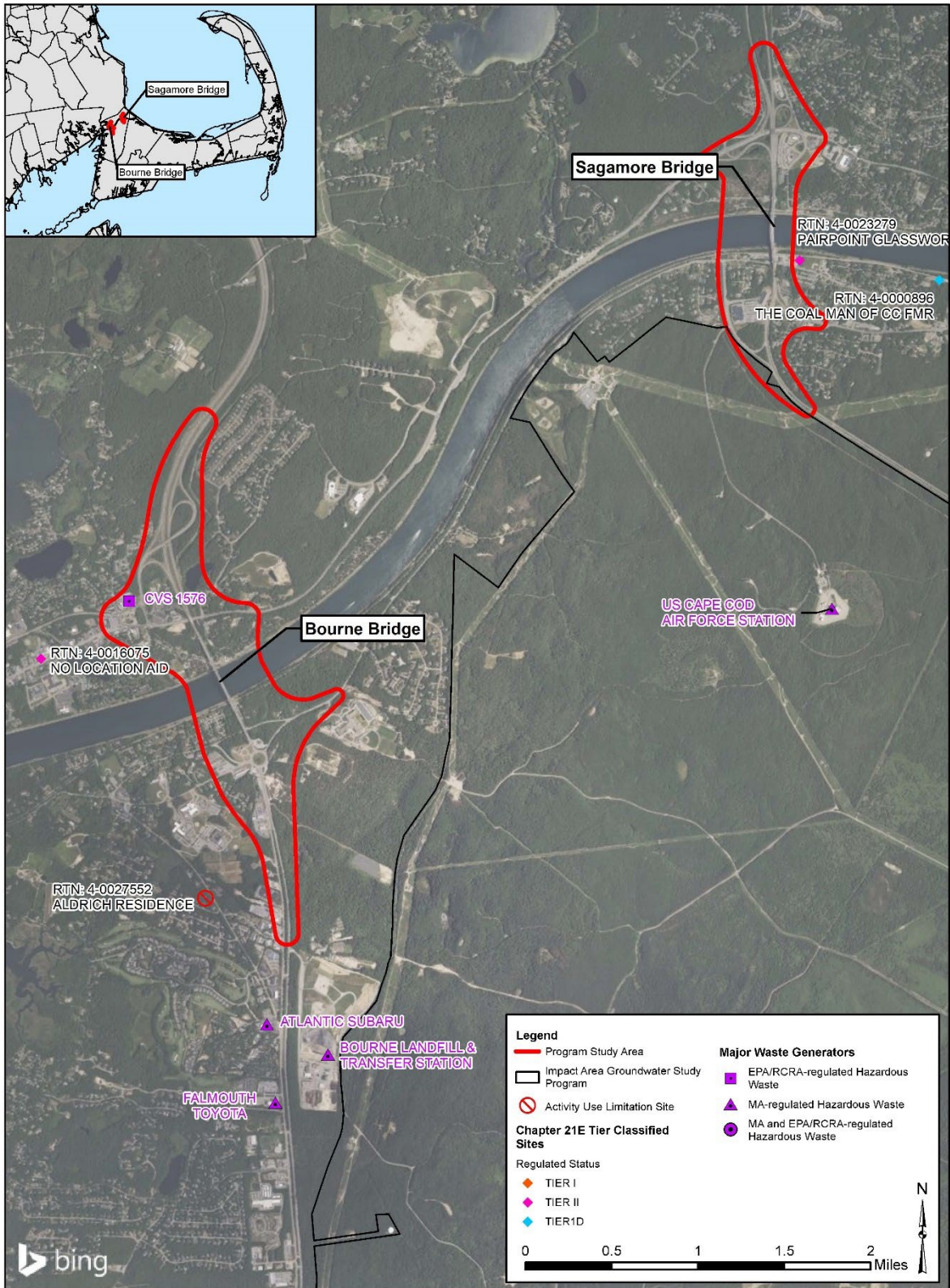


Figure 3-9. Environmentally Impacted Land Uses in and Near the Program Study Areas

### 3.3 Preliminary Impact Assessment

Section 3.3 presents potential Program impacts to land, including altered land areas, private property, and protected land uses. Preliminary impacts include impacts due to the Program’s bridge replacement structures (including profile and cross section), fully offline inboard mainline alignment location, center span length, paired with the interchange approach alternatives.

Section 2.1 shows schematics of the preferred mainline alignment location (Figures 2-3 and 2-4) and center span length (Figure 2-6). The ten interchange approach alternatives are presented in Section 2.1.5 and summarized in Table 2-1. Figures 2-7 through 2-16 in Section 2.1.5 present schematics of the preferred interchange approach alternatives.

#### 3.3.1 Potential Altered Land Areas

To estimate the potential permanent land alterations of the Program, the interchange approach schematics shown in Section 2.1.5 (Figures 2-7 through 2-13) were overlaid on existing conditions.

Tables 3-1 through 3-4 show preliminary estimated acres of land alteration in the Bourne and Sagamore Program Study Areas. Potential changes are compared to existing conditions. With all alternatives, there would be an overall increase in altered land consisting of additional impervious areas due to new and/or reconfigured roadways; additional paved areas associated with shared use paths; and additional altered areas due to grading and best management practices (BMPs), such as vegetated strips, water quality swales and infiltration basins.

**Table 3-1. Bourne North Program Study Area – Estimated Acres of Land Alteration**

Project Site Description	Bourne North Crossing Interchange Approach Alternatives								
	Northbound On-Ramp			Single Exit Parcel Interchange			Directional Interchange		
	Acres (Rounded)								
	Existing	Change	Total	Existing	Change	Total	Existing	Change	Total
<b>Total Impervious area (a)</b>	42.8	+7.0	49.8	42.5	+8.6	51.1	42.5	+6.2	48.7
<b>Internal roadways only</b>	20.3	+3.5	23.8	20.3	+4.8	25.2	20.3	+2.5	22.8
<b>Other paved areas (b)</b>	22.5	+3.5	26.0	22.2	+3.7	25.9	22.2	+3.7	25.9
<b>Other Altered Areas (c)</b>	---	+25.5	25.5	---	+19.4	19.4	---	+22.0	22.0
<b>Undeveloped areas (d)</b>	205.5	-32.5	173.0	205.8	-27.9	177.9	205.8	-28.2	177.6

Project Site Description	Bourne North Crossing Interchange Approach Alternatives								
	Northbound On-Ramp			Single Exit Parcel Interchange			Directional Interchange		
	Acres (Rounded)								
	Existing	Change	Total	Existing	Change	Total	Existing	Change	Total
<b>Total Area of Program Limits (e)</b>	248.3	---	248.3	248.3	---	248.3	248.3	---	248.3

Notes: 1) Definitions of Project Site Description: (a) Total impervious area = Internal roadways + Other paved areas; (b) Other paved areas = parking, sidewalks, shared use paths; (c) Other altered areas = Limits of grading, BMPs, etc.; (d) Undeveloped areas = Not impacted during construction; (e) Total area of Program limits = Total impervious area + Other altered areas + Undeveloped areas. 2) Rounding may result in minor discrepancies in total impacts.

**Table 3-2. Bourne South Program Study Area - Estimated Acres of Land Alteration**

Project Site Description	Bourne South Crossing Interchange Approach Alternatives					
	Diamond Interchange			Single-Point Interchange		
	Acres (Rounded)					
	Existing	Change	Total	Existing	Change	Total
<b>Total Impervious area (a)</b>	47.5	+8.8	55.7	47.5	+7.8	55.3
<b>Internal roadways only</b>	18.1	+7.6	25.2	18.1	+6.3	24.4
<b>Other paved areas (b)</b>	29.4	+1.2	30.6	29.4	+1.5	30.8
<b>Other Altered Areas (c)</b>	---	+42.4	42.8	---	+43.3	43.3
<b>Undeveloped areas (d)</b>	171.1	-51.1	120.0	171.1	-51.1	120.0
<b>Total Area of Program Limits (e)</b>	218.5	---	218.5	218.5	---	218.5

Notes: 1) Definitions of Project Site Description: (a) Total impervious area = Internal roadways + Other paved areas; (b) Other paved areas = parking, sidewalks, shared use paths; (c) Other altered areas = Limits of grading, BMPs, etc.; (d) Undeveloped areas = Not impacted during construction; (e) Total area of Program limits = Total impervious area + Other altered areas + Undeveloped areas. 2) Rounding may result in minor discrepancies in total impacts.

**Table 3-3. Sagamore North Program Study Area - Estimated Acres of Land Alteration**

Project Site Description	Sagamore North Crossing Interchange Approach Alternatives					
	Similar to Existing Configuration			Direct Connection to State Road		
	Acres (Rounded)					
	Existing	Change	Total	Existing	Change	Total
<b>Total Impervious area (a)</b>	23.3	+7.5	30.8	23.4	+9.0	32.4
<b>Internal roadways only</b>	20.0	+7.7	27.7	20.1	+8.3	28.4
<b>Other paved areas (b)</b>	3.3	-0.2	3.1	3.3	+0.7	4.0
<b>Other Altered Areas (c)</b>	0	+41.0	41.0	0	+39.5	39.5
<b>Undeveloped areas (d)</b>	178.1	-48.5	129.6	178.0	-48.5	129.5

Project Site Description	Sagamore North Crossing Interchange Approach Alternatives					
	Similar to Existing Configuration			Direct Connection to State Road		
	Acres (Rounded)					
	Existing	Change	Total	Existing	Change	Total
<b>Total Area of Program Limits (e)</b>	201.4	---	201.4	201.4	---	201.4

Notes: 1) Definitions of Project Site Description: (a) Total impervious area = Internal roadways + Other paved areas; (b) Other paved areas = parking, sidewalks, shared use paths; (c) Other altered areas = Limits of grading, BMPs, etc.; (d) Undeveloped areas = Not impacted during construction; (e) Total area of Program limits = Total impervious area + Other altered areas + Undeveloped areas. 2) Rounding may result in minor discrepancies in total impacts.

**Table 3-4. Sagamore South Program Study Area - Estimated Acres of Land Alteration**

Project Site Description	Sagamore South Crossing Interchange Approach Alternatives								
	Similar to Existing Configuration with Cranberry Highway Extension			Similar to Existing Configuration			Westbound On-Ramp Under Route 6		
	Acres (Rounded)								
	Existing	Change	Total	Existing	Change	Total	Existing	Change	Total
<b>Total Impervious area (a)</b>	22.7	+5.9	28.5	22.7	+3.1	26.4	23.1	+5.3	28.4
<b>Internal roadways only</b>	15.6	+9.7	25.2	15.6	+7.3	23.5	16.0	+9.2	25.2
<b>Other paved areas (b)</b>	7.1	-3.8	3.3	7.1	-4.2	2.9	7.1	-3.9	3.2
<b>Other Altered Areas (c)</b>	0	+30.7	30.7	0	+33.4	32.8	0	+31.4	31.4
<b>Undeveloped areas (d)</b>	144.8	-36.5	108.3	144.8	-36.5	108.3	144.4	-36.7	107.7
<b>Total Area of Program Limits (e)</b>	167.5	---	167.5	167.5	---	167.5	167.5	---	167.5

Notes: 1) Definitions of Project Site Description: (a) Total impervious area = Internal roadways + Other paved areas; (b) Other paved areas = parking, sidewalks, shared use paths; (c) Other altered areas = Limits of grading, BMPs, etc.; (d) Undeveloped areas = Not impacted during construction; (e) Total area of Program limits = Total impervious area + Other altered areas + Undeveloped areas. 2) Rounding may result in minor discrepancies in total impacts.

### 3.3.2 Potential Private Property Impacts

Tables 3-5 and 3-6 present potential permanent (operational) impacts to private property in the Program Study Areas associated with the Program based on preliminary/conceptual design. The total anticipated impacts for each Program Study Area include the impacts of the fully offline inboard

mainline alignment location at each bridge crossing, paired with each of the highway interchange approach alternatives. Partial impacts are defined as impacts that would not affect the structure (or dwelling) and would involve a partial acquisition (strip taking). Full impacts are defined as impacts that would involve a full parcel acquisition.

**Table 3-5. Bourne Program Study Area - Estimated Permanent Private Property Impacts**

Property Impacts	Bourne Crossing Interchange Approach Alternatives				
	Bourne North Crossing			Bourne South Crossing	
	Northbound On-Ramp	Single Exit Partial Interchange	Directional Interchange	Diamond Interchange	Single Point Interchange
<b>Residential Impacts</b>					
• Partial Impacts	4	5	4	1	1
• Full Impacts	0	0	1	0	0
<b>Commercial Impacts</b>					
• Partial Impacts	4	5	4	3	3
• Full Impacts	5	5	5	5	5
<b>Total Impacts</b>					
• Partial Impacts	8	10	8	4	4
• Full Impacts	5	5	6	5	5

Partial impacts = impacts that would not affect the structure and would involve a partial acquisition.

Full impacts = impacts that would involve a full parcel acquisition.

**Table 3-6. Sagamore Program Study Area - Estimated Permanent Private Property Impacts**

Property Impacts	Sagamore Crossing Interchange Approach Alternatives				
	Sagamore North Crossing		Sagamore South Crossing		
	Similar to Existing Configuration	Direct Connection to State Road	Similar to Existing Configuration with Cranberry Highway Extension	Similar to Existing Configuration	Westbound On-Ramp Under Route 6
<b>Residential Impacts</b>					
• Partial Impacts	0	0	10	9	10
• Full Impacts	11	11	13	13	13
<b>Commercial Impacts</b>					
• Partial Impacts	1	1	10	10	9
• Full Impacts	2	2	3	3	3
<b>Total Impacts</b>					



Property Impacts	Sagamore Crossing Interchange Approach Alternatives				
	Sagamore North Crossing		Sagamore South Crossing		
	Similar to Existing Configuration	Direct Connection to State Road	Similar to Existing Configuration with Cranberry Highway Extension	Similar to Existing Configuration	Westbound On-Ramp Under Route 6
• Partial Impacts	1	1	20	19	19
• Full Impacts	13	13	16	16	16

Partial impacts = impacts that would not affect the structure and would involve a partial acquisition.  
 Full impacts = impacts that would involve a full parcel acquisition.

### 3.3.3 Potential Open Space Impacts

Tables 3-7 and 3-8 present potential impacts to open space in the Program Study Areas based on preliminary/conceptual design. Impacts could include permanent operational impacts, temporary construction-related impacts, or both permanent and temporary impacts. Open space impacts anticipated for each Program Study Area include the impacts of the fully offline inbound mainline alignment location at each bridge crossing, paired with each of the highway interchange approach alternatives. Based on the preliminary/conceptual design, the Program would not trigger an Article 97 land disposition.

**Table 3-7. Bourne Program Study Area – Potential Open Space Impacts**

Open Space	Bourne Crossing Interchange Approach Alternatives				
	Bourne North Crossing			Bourne South Crossing	
	Northbound On-Ramp	Single Exit Partial Interchange	Directional Interchange	Diamond Interchange	Single-Point Interchange
	Permanent (P) /Temporary (T) Impacts				
Cape Cod Land Bank/Buzzards Bay Water District	T	T	T		
USACE Federal Navigation Project	P&T	P&T	P&T	P&T	P&T
Nightingale Pond Conservation Area	No	No	No		
Town of Bourne Scenic Park	P&T	P&T	P&T	P&T	P&T

Open Space	Bourne Crossing Interchange Approach Alternatives				
	Bourne North Crossing			Bourne South Crossing	
	Northbound On-Ramp	Single Exit Partial Interchange	Directional Interchange	Diamond Interchange	Single-Point Interchange
Permanent (P) /Temporary (T) Impacts					
Sandwich Road Conservation Area				No	No
Bourne High School Recreational Fields				T	T
Upper Cape Cod Regional Technical School				P&T	P&T
Jackson Purchase				No	No
Korff Conservation Land				No	No
Walsh Conservation Land				No	No

P= permanent impacts; T= temporary impacts;  = not applicable

**Table 3-8. Sagamore Program Study Area – Potential Open Space Impacts**

Open Space	Sagamore Crossing Interchange Approach Alternatives				
	Sagamore North Crossing		Sagamore South Crossing		
	Similar to Existing Configuration	Direct Connection to State Road	Similar to Existing Configuration with Cranberry Highway Extension	Similar to Existing Configuration	Westbound On-Ramp Under Route 6
Permanent (P) /Temporary (T) Impacts					
USACE Federal Navigation Project	P&T	P&T	P&T	P&T	P&T
Herring Pond Watershed Area ACEC	P&T	P&T			
Upper Cape Water Supply			T	T	T

Open Space	Sagamore Crossing Interchange Approach Alternatives				
	Sagamore North Crossing		Sagamore South Crossing		
	Similar to Existing Configuration	Direct Connection to State Road	Similar to Existing Configuration with Cranberry Highway Extension	Similar to Existing Configuration	Westbound On-Ramp Under Route 6
	Permanent (P) /Temporary (T) Impacts				
Reserve/Camp Edwards WMA					
Shawme-Crowell State Forest			No	No	No

P= permanent impacts; T= temporary impacts;  = not applicable

### 3.4 Next Steps

MassDOT will refine impacts to land, private properties, and open space as design advances. The DEIR will present refined land and property impacts of the Bourne and Sagamore highway interchange alternatives. MassDOT will identify mitigation measures to address property and land use impacts of the Cape Cod Bridges Program in the DEIR.

### 3.5 Consistency with Planning

#### 3.5.1 Town of Bourne Local Comprehensive Plan

The Town of Bourne Local Comprehensive Plan (LCP), revised 2019, was approved by Town Meeting on October 29, 2019, and certified by the Cape Cod Commission in December 2019.

The existing condition and future disposition of the Bourne and Sagamore Bridges is a key topic in the Town of Bourne LCP, as both highway bridges are in the Town of Bourne. In January 2017, the Town signed a Community Compact with the Commonwealth of Massachusetts to support a town-wide assessment of the town’s economic strengths and weaknesses, and external opportunities and threats facing the community. In November 2017, the community participated in Strengths, Weaknesses, Opportunities, and Threats (SWOT) workshops to update the economic development section of the Local Comprehensive Plan. Weaknesses and threats identified by the community included the following: heavy traffic passing through town to other locations on Cape Cod, narrow and aging bridges crossing the canal, increasing traffic volume and congestion year-round, and lack of local control over highways and the canal bridges. The LCP cites traffic and transportation issues as one of the highest priority issues, including elimination of rotaries and traffic circles, replacement of the two canal bridges, and expansion of capacity and safety of Sandwich Road, MacArthur Boulevard, and Scenic Highway.

The Cape Cod Bridges Program is consistent with the LCP of the Town of Bourne regarding economic development, transportation needs, open space, and land use. This consistency is described in the following sections.

### 3.5.1.1 Economic Development

The Cape Cod Bridges Program, specifically the inclusion of shared use paths on the bridges, is consistent with an economic policy of the Town of Bourne: *Recognize the economic benefit to Bourne generated by recreational activities such as marinas, golf courses, recreational trails, and the Cape Cod Baseball League*. In its “Vision for Bourne,” the LCP cites the need for expanded sidewalk and trail access for pedestrians and cyclists, with the high priority of extending the Shining Sea Trail from North Falmouth to Cape Cod Canal to boost the local economy, provide off-road bicycle and pedestrian connections among Bourne’s villages, and increase public safety.

The replacement highway bridges, and their interchange approaches would include shared use pedestrian and bicycle paths that would provide connections on both sides of the canal to the local roadway network in the Town of Bourne.

### 3.5.1.2 Adequacy of Infrastructure

The Cape Cod Bridges Program is consistent with the infrastructure policies of the LCP as expressed through its transportation goals, coastal resiliency goals, and capital facilities and infrastructure goals. Included in the Cape Cod Bridges Program’s Purpose and Need statement is the need to address the increasing maintenance needs and functional obsolescence of the aging Cape Cod Canal highway bridges. Additionally, the Program would include upgrading the roadway network approaches to the highway bridges. Further, MassDOT proposes to place a high priority on construction means and methods that would minimize work zone impacts on the traveling public.

Transportation goals of the LCP include improving the flow of through traffic crossing Bourne and separating through traffic from local traffic to allow both to move freely without interfering with each other. Transportation actions identified in the LCP include urging the USACE to accelerate plans to replace the canal bridges, supporting the MassDOT plan to replace the Bourne Bridge Rotary with a conventional highway interchange, promoting construction of more park and ride lots near the canal bridges, and reconstructing Sandwich Road between the canal bridges into a divided highway. As part of the Cape Cod Bridges Program, MassDOT proposes to continue coordination with the Town of Bourne to identify ways in which these goals can be accomplished.

The Cape Cod Bridges Program is consistent with a coastal resiliency goal of the Town of Bourne LCP to minimize and mitigate the effect of sea level rise on the town’s infrastructure. To maintain the existing 135-foot federal vertical navigational clearance requirement, MassDOT proposes to increase the elevation of the highway bridges by approximately three feet to account for future sea level rise. As design advances, MassDOT will incorporate design features into Program elements to maximize climate resiliency.

### 3.5.1.3 Open Space Impacts

The Cape Cod Bridges Program is consistent with the open space policy of the LCP to enhance public access to existing conservation land and to establish green corridors and/or connections, as evidenced through the incorporation of a shared-use path for each highway bridge that includes connections to the local roadway network. The Cape Cod Bridges Program would minimize impacts to open space, including the USACE-leased property on the canal, to the greatest extent practicable.

The Cape Cod Bridges Program is consistent with the LCP's goal to protect the public rights for fishing, navigation, and recreation. The replacement highway bridges would maintain and improve navigational passage through Cape Cod Canal, with an increased bridge height to account for future sea level rise and an effective increase in horizontal clearance at the bridges due to the relocation of the bridge foundations outside the waterway. Additionally, as indicated in the selection of the preferred bridge type, MassDOT proposes to incorporate construction means and methods that would minimize impacts to canal navigation.

### 3.5.1.4 Compatibility with Adjacent Land Uses

With in-kind highway bridge replacements updated to comply with federal and state highway and design safety standards, the Cape Cod Bridges Program would not substantially alter existing conditions relative to adjacent land uses. The purpose of the Cape Cod Bridges Program is to address the substandard design of the bridges and their approach roadway networks to comply with current MassDOT and FHWA design and safety standards. While the bridges would provide travel lanes wider than the existing lanes and an entrance and exit (auxiliary) lane to provide a safer interface with the highway interchange access ramps, the Program would not include additional travel lanes on the approaching roadways. To the greatest extent practicable, MassDOT would minimize the Program's construction and operational impacts upon adjacent properties.

The Cape Cod Bridges Program is consistent with the LCP's cultural heritage goal to protect and preserve historic and cultural features of the town's landscape and to ensure that future development respects the town's historic traditions. In coordination with the Massachusetts Historical Commission, MassDOT will identify measures in the Program's Programmatic Agreement and Memorandum of Agreement to mitigate the loss of the historic bridges. Additionally, MassDOT is developing the design of the replacement bridges in coordination with historic stakeholders, including the public.

## 3.5.2 Cape Cod Regional Policy Plan

The Cape Cod Regional Policy Plan (RPP), prepared by the Cape Cod Commission in December 2018, was approved by Barnstable County Ordinance #19-01, effective February 22, 2019. The Cape Cod RPP cites additional regional and local planning efforts that focus on issue-specific regional planning topics, such as the 2016 Regional Transportation Plan, and form the foundation for the RPP. Since the issuance of the RPP, the Cape Cod Commission has issued technical bulletins that clarify how projects can meet the goals and objectives of the RPP. Related to the RPP is the 2021 Cape Cod Climate Action Plan, July 2021, which addresses vulnerabilities in public infrastructure.

MassDOT recognizes the Cape Cod Commission as a key stakeholder in the development and implementation of the Cape Cod Bridges Program. As noted in Section 9.4, MassDOT has solicited the views of the Cape Cod Commission through project briefings. MassDOT will continue to include the Cape Cod Commission in the MEPA and NEPA analysis and documentation processes.

#### 3.5.2.1 Economic Development

The Cape Cod Commission cites climate change and provision of adequate infrastructure as key challenges facing the region noting that the long-term challenge is to maintain and improve the quality of the environment to ensure a stable and robust economy. Further, the RPP states that the Bourne and Sagamore highway bridges are critical to the long-term viability of the Cape Cod region.

The Cape Cod Bridges Program is consistent with the long-term economic goals of the RPP. The Program addresses the challenges of responding to climate change and providing adequate infrastructure. The vertical clearance of the replacement bridges would be adjusted to allow for future sea level rise, thereby incorporating resiliency into the structures. Additionally, the replacement bridges would address the functional obsolescence of the existing structures by incorporating current highway design standards.

The Cape Cod Bridges Program is consistent with a goal of the Cape Cod Regional Transportation Plan (RTP) to improve the efficiency and reliability of freight movement. The RTP acknowledges that congestion and poor travel time reliability affect the freight industry and, by extension, the local economies, noting that efforts to improve the freight network on Cape Cod will support long-term economic stability. To improve the efficiency and reliability of freight movement, the RTP identifies two objectives: reduce delays and improve travel time reliability on the freight network and minimize Cape Cod Canal bridge maintenance impacts. By replacing the functionally obsolete bridges, the Cape Cod Bridges Program would address the existing poor traffic operations and the ongoing maintenance needs of the existing bridges.

#### 3.5.2.2 Adequacy of Infrastructure

Two goals of the Cape Cod RPP are related to the adequacy of infrastructure: capital facilities and infrastructure, and transportation. The Cape Cod Bridges Program is consistent with these goals and their related objectives.

The RPP seeks to guide the development of capital facilities and infrastructure necessary to meet the region's needs while protecting regional resources by ensuring that they promote long-term sustainability and resiliency. MassDOT is designing the replacement highway bridges to maximize sustainability and resiliency. By providing two highway structures at each crossing, MassDOT would be able to completely close one structure in the event of a compromising event, while still accommodating traffic operations on the second structure. Additionally, by incorporating additional height to accommodate sea level rise and by locating the bridge piers outside the waterway, MassDOT would provide for safer and reliable navigation at the bridge sites while improving the resiliency of the structures.

Objectives to meet the RPP's goal of providing and promoting a safe, reliable, and multi-modal transportation system include improving safety and eliminating hazards for all users of Cape Cod's transportation system and providing an efficient and reliable transportation system that will serve the current and future needs of the region and its people. MassDOT is designing the replacement highway bridges to address their functional obsolescence and improve safety conditions. To conform to current highway design standards, MassDOT would incorporate wider travel lanes and an inside shoulder and outside shoulder in each direction.

The Cape Cod Bridges Program is consistent multiple strategies of the Cape Cod Climate Action Plan to address vulnerabilities in public infrastructure and in the road network, manage development in coastal resource areas, and support low and no carbon transportation options. The Program would incorporate stormwater improvements, including best management practices and green infrastructure, where space permits to provide water quality treatment measures. Additionally, by providing shared use paths on the bridges to connect with the local roadway network, the Program would enhance existing bicycle and pedestrian options.

### 3.5.2.3 Open Space Impacts

The Cape Cod Bridges Program is consistent with the open space and related community design and cultural heritage goals of the Cape Cod RPP. The RPP's open space goal is to conserve, preserve, or enhance a network of open space that contributes to the region's natural and community resources and systems. The RPP's community design goal is to protect and enhance the unique character of the region's built and natural environment based on the local context. The RPP's cultural heritage goal is to protect and preserve the significant cultural, historic, and archaeological values and resources of Cape Cod.

MassDOT is designing the replacement bridges to minimize impacts to adjacent land uses, including operational and construction impacts to maritime uses. Additionally, the replacement highways each would include a pedestrian/bicyclist shared use path, which would connect to existing rail trails on both sides of the canal. To address RPP's cultural heritage goal, the Cape Cod Bridges Program would include a Memorandum of Agreement to incorporate measures to mitigate for the demolition of the historic bridges.

## 4 Rare Species Section

This section presents the extent of known and potential habitat for state and federally protected rare, threatened, and endangered species with the Program Study Areas. Additionally, it presents a preliminary habitat impact assessment based on conceptual design.

### 4.1 Existing Conditions

According to the Massachusetts Natural Heritage and Endangered Species Program (NHESP) 15th Edition Natural Heritage Atlas (Attachment 6.1), the Bourne and Sagamore Program Study Areas are within and near mapped Priority Habitat and Estimated Habitat, as shown in Figures 4-1 and 4-2.

The U.S. Fish and Wildlife Service (USFWS) Information for Planning and Consultation Tool (IPAC) identified the potential presence of the federally endangered northern long-eared bat (*Myotis septentrionalis*, NLEB) and endangered Plymouth Redbelly turtle (*Pseudemys rubriventris bangsi*) within the vicinity of the Program Study Areas. There are no critical habitats<sup>6</sup> for either species within either Program Study Area.

The National Oceanic and Atmospheric Administration (NOAA) Fisheries Mapper identified Essential Fish Habitat (EFH)<sup>7</sup> within the Cape Cod Canal for 30 species. The Canal was also identified as a Habitat Area of Particular Concern<sup>8</sup> for Summer Flounder (*Paralichthys dentatus*) and Atlantic Cod (*Gadus morhua*). The National Marine Fisheries Service (NMFS) Section 7 Mapper<sup>9</sup> identified 11 federally protected aquatic species within the Cape Cod Canal.

Section 4.1.1 describes MassDOT's consultations with NHESP, USFWS, and NNMFS, as well as field investigations conducted in 2020 to identify rare, threatened, and endangered species within and near the Program Study Areas.

---

<sup>6</sup> Critical habitat is the specific areas within the geographic area, occupied by the species at the time it was listed, that contain the physical or biological features that are essential to the conservation of endangered and threatened species and that may need special management or protection. Critical habitat may also include areas that were not occupied by the species at the time of listing but are essential to its conservation. (<https://www.fws.gov/sites/default/files/documents/critical-habitat-fact-sheet.pdf>)

<sup>7</sup> Essential Fish Habitat includes coral reefs, kelp forests, bays, wetlands, rivers, and even areas of the deep ocean that are necessary for fish reproduction, growth, feeding, and shelter. Essential fish habitat covers federally managed fish and invertebrates, but it does not apply to strictly freshwater species. ([fisheries.noaa.gov/insight/understanding-essential-fish-habitat](https://fisheries.noaa.gov/insight/understanding-essential-fish-habitat))

<sup>8</sup> Habitat Areas of Particular Concern are subsets of Essential Fish Habitat that exhibit one or more of the following traits: rare, stressed by development, provide important ecological functions for federally managed species, or are especially vulnerable to human impact degradation. (<https://www.fisheries.noaa.gov/southeast/habitat-conservation/habitat-areas-particular-concern-within-essential-fish-habitat>)

<sup>9</sup> <https://www.fisheries.noaa.gov/resource/map/greater-atlantic-region-esa-section-7-mapper>





**Figure 4-1. NHESP Estimated and Priority Habitat in the Bourne Program Study Area**



**Figure 4-2. NHESP Estimated and Priority Habitat in the Sagamore Program Study Area**

#### 4.1.1 Agency Consultation and Coordination

As part of the MRER/EA, the USACE initiated coordination with USFWS and NMFS in 2019 to identify listed and “at-risk” species and critical habitat near the Bourne and Sagamore bridges, including EFH in Cape Cod Canal. Attachments 6.2 and 6.3 provide documentation of these early agency coordination activities.

Beginning in 2016, MassDOT initiated early consultation with the NHESP via a Massachusetts Endangered Species Act (MESA) Information Request to obtain information on state-listed species documented within NHESP Priority Habitat that intersects the Bourne and Sagamore Program Study Areas. NHESP identified 13 MESA-protected species within the Program Study Areas and that could be affected by the proposed work.

MassDOT also coordinated with USFWS early in Program development to assess concerns for the identified rare, threatened, and endangered species. Table 4.1 classifies the identified MESA-protected species by taxonomic group.

**Table 4.1. MESA-Listed Species by Taxonomic Group Identified in the Program Study Areas**

Taxonomic Group	Number of MESA-listed Species Identified in the Program Study Areas
Invertebrate	9
Plant	1
Reptile	1
Mammal	2
Total	13

Coordination with NHESP also identified a request to perform a habitat assessment for the New England cottontail (*Sylvilagus transitionalis*) due to ongoing species recovery efforts in the region under the U.S. Fish and Wildlife Coordination Act.

Section 4.1.2 summarizes the findings of the habitat assessment for the MESA-listed species and the New England cottontail.

#### 4.1.2 Rare, Threatened and Endangered Species Habitat Assessment

In Summer 2020, MassDOT conducted a Rare, Threatened, and Endangered Species (RTE) Habitat Assessment within and adjacent to the Program Study Areas. The assessment utilized NHESP survey methodology<sup>10</sup> to identify and characterize the existing habitats that may be suitable for protected species. A Study Plan for this assessment was submitted and approved by NHESP and USFWS prior to initiating the field survey. NHESP coordinated with MassDOT during the in-progress habitat assessment to discuss existing conditions and initial site observations.

<sup>10</sup>NHESP-approved qualified biologists used the Habitat Assessment: Wildlife guidelines. Available at: <https://www.mass.gov/doc/state-listed-species-habitat-assessment-guidelines-wildlife/download>

The Program Study Areas include transportation infrastructure adjacent to numerous commercial and residential developments. Small and often fragmented forest patches are uncommon and occur near or adjacent to larger tracts of undeveloped land. Joint Base Cape Cod (JBCC) is located south of the Sagamore and Bourne Bridges and represents an area greater than 20,000 acres with multiple land uses, including natural resource management (Camp Edwards Wildlife Management Area). Variations of pitch pine – oak forest are the dominant ecological community within undeveloped areas. This is a matrix forest within the southeastern Massachusetts region and consists of a generally mature forest with overall low species diversity and well drained sandy loam soils. The canopy includes a mix of pitch pine (*Pinus rigida*) and several oaks including most frequently northern red oak (*Quercus rubra*) and white oak (*Quercus alba*). The understory is dominated by shrubs with black huckleberry (*Galussacia baccata*) ubiquitous throughout the community. Additional woody understory species characteristic of this community includes sheep-laurel (*Kalmia angustifolia*), common low-bush blueberry (*Vaccinium angustifolium*), hillside blueberry (*Vaccinium pallidum*), deerberry (*Vaccinium stramineum*), and roundleaf greenbrier (*Smilax rotundifolia*). Herbaceous plants are low in diversity and commonly include wintergreen (*Gaultheria procumbens*), bracken fern (*Pteridium aquilinum*), wild sarsaparilla (*Aralia nudicaulis*), and Pennsylvania sedge (*Carex pensylvanica*).

The RTE Habitat Assessment confirmed that potential suitable habitat for several of the target MESA-listed wildlife and moth species; and New England cottontail occurs south of the Bourne and Sagamore Bridges and adjacent to existing transportation infrastructure within the Program Study Areas, notably Routes 6 and 28. These roadways in some cases represent a barrier to wildlife migration; and the roadside potential suitable habitat represents edge habitat for the targeted species. These habitats also occur along the northern and eastern periphery of JBCC.

In addition to the potential suitable roadside habitats, the 350-foot-wide Eversource electrical transmission right-of-way (ROW), also provides suitable habitat for many of the target species. The field observations of potential suitable habitat coincide with the NHESP's mapping of Priority Habitat within and near the Program Study Areas. No mapped Priority or Estimated Habitat occur within 1,500 feet of the Program Study Area north of the Bourne and Sagamore Bridges.

Black huckleberry (*Gaylussacia baccata*), blueberries (*Vaccinium spp.*), and scrub oak (*Quercus ilicifolia*) are the primary host plants for the MESA-listed moth species and the presence of the host plants may indicate the presence of the moth species within the Program Study Area. The assessment identified the presence of black huckleberry and blueberries south of the Sagamore Bridge, primarily within the existing Eversource ROW. Scrub oak also was identified south of the Sagamore Bridge, primarily within the existing Eversource ROW and south of the Bourne Bridge, located east of Route 28.

Suitable New England cottontail habitat was identified south of the Sagamore Bridge within the existing Eversource ROW. A roadkill possible cottontail rabbit was encountered south of the Sagamore Bridge adjacent to the JBCC along the north side of the Route 6 travel lane during the RTE Habitat Assessment.

No specimens or suitable habitat for MESA-listed plants was observed within the Program Study Areas. The results of the RTE Habitat Assessment were provided to the Massachusetts Division of Fisheries and Wildlife (MassWildlife) for review and consideration as part of the ongoing MESA consultation.

#### **4.1.3 Northern Long-Eared Bat Acoustic Survey**

During the 2020 summer NLEB maternity season (May 15 – August 15), MassDOT commissioned an acoustic bat survey to evaluate the presence or probable absence of NLEB within the Program Study Areas and adjacent areas. The survey was conducted using methods outlined by the USFWS March 2020 Range-wide Indiana Bat Summer Survey Guidelines,<sup>11</sup> and a study plan was submitted and approved by USFWS prior to initiating the field survey. Detectors to identify and record nearby bat vocalizations, of both rare and common species, were positioned in 22 locations on July 20-24, 2020, within potential suitable NLEB habitat along forested edges, railroad corridors, near canopy openings, adjacent to wetlands or near open field areas. The number of and locations for the detectors were based on USFWS survey protocol for linear projects and the USFWS-approved Study Plan. A total of 44-detector nights were conducted (22 detectors deployed for 2 nights each), distributed among five locations. The 2020 acoustic survey did not deploy detectors or include an assessment of NLEB habitat suitability at either bridge due to safety or logistical considerations. Bat biologists analyzed the recorded vocalizations using USFWS-approved software and visual techniques. The survey also characterized potential suitable NLEB bat habitat on either side of both bridges.

The survey results identified suitable forested habitat for some common and rare bats adjacent to existing roads and traversed residential and commercial areas north and south of the Bourne and Sagamore Bridges. The forested habitat is consistent with the pitch pine – oak forest matrix common in the region.

The survey did not identify presence of NLEB within or adjacent to the Program Study Areas, indicating probable absence of NLEB maternity colonies in 2020. The survey confirmed the presence of little brown bat (*Myotis lucifugus*), MESA-listed as endangered,<sup>12</sup> and tricolored bat<sup>13</sup>, MESA-listed as Endangered, east of the south approach to the Bourne Bridge and north of the north approach to the Sagamore Bridge. According to the USFWS March 2020 Range-wide Indiana Bat Summer Survey Guidelines, the survey is valid for a duration of five years from its completion (through July 24, 2025).

---

<sup>11</sup> USFWS indicated that the Range-wide Indiana Bat Summer Survey Guidelines were to be used to detect presence of NLEB and Indiana bats. Available at <https://www.fws.gov/midwest/endangered/mammals/inba/inbasummersurveyguidance.html>

<sup>12</sup> The USFWS is currently reviewing the little brown bat for protection under the Federal ESA.

<sup>13</sup> On September 14, 2022, The USFWS proposed to list the tricolored bat as an endangered species under the Federal ESA. Available at: <https://www.govinfo.gov/content/pkg/FR-2022-09-14/pdf/2022-18852.pdf>

## 4.2 Preliminary Impact Assessment

Early consultations with the NHESP indicate that the Cape Cod Bridges Program could result in a “take” of species protected under MESA.<sup>14</sup> Impacts to rare, threatened, and endangered species habitat will be assessed as the Program design is advanced.

## 4.3 Next Steps

MassDOT will continue coordination with USFWS to determine the need for follow-up acoustic bat surveys to evaluate the presence or probable absence of endangered NLEB within and adjacent to the Program Study Areas. Should future acoustic surveys indicate the presence of federally listed bats, MassDOT will coordinate with USFWS to assess required measures for species protection. MassDOT will continue to coordinate with MassWildlife, USFWS, and NMFS through design to confirm the presence of protected species, critical habitat, and EFH in the Program Study Areas and to identify potential impacts and measures to protect species, critical habitat, and EFH. The DEIR will identify best management practices to meet state and federal performance standards and to address other resource agency recommendations. Additionally, the DEIR will include documentation of agency coordination and consultation activities.

# 5 Wetlands, Waterways, and Tidelands Section

This section presents existing wetland and waterway resources in the Program Study Areas and identifies preliminary impacts of the Program based on conceptual design.

## 5.1 Existing Conditions

A field delineation of wetland resources was completed June 12 - September 18, 2020. Wetlands were delineated in accordance with the *U.S. Army Corps of Engineers (USACE) Wetland Delineation Manual* (1987 edition) and *Regional Supplement to the Corps of Engineers Wetland Delineation Manual: Northcentral and Northeast Region, Version 2.0* to identify resource areas that meet the criteria for both state and federal jurisdiction. Figures 5-1 through 5-4 show the presence and extent of wetlands, waterbodies, and watercourses within the Program Study Areas that meet the criteria for state regulation under the Massachusetts Wetland Protection Act (WPA; 310 CMR 10.00).

The Program Study Areas, as well as all of Cape Cod, are included in the Massachusetts coastal zone boundary. Figure 5-5 shows coastal resources in the Bourne and Sagamore Program Study Areas.

---

<sup>14</sup> In reference to animals, a “take” means to harass, harm, pursue, hunt, shoot, hound, kill, trap, capture, collect, process, disrupt the nesting, breeding, feeding or migratory activity or attempt to engage in any such conduct, or to assist such conduct. In reference to plants, a “take” means to collect, pick, kill, transplant, cut or process or attempt to engage or to assist in any such conduct. Disruption of nesting, breeding, feeding or migratory activity may result from, but is not limited to, the modification, degradation, or destruction of Habitat.

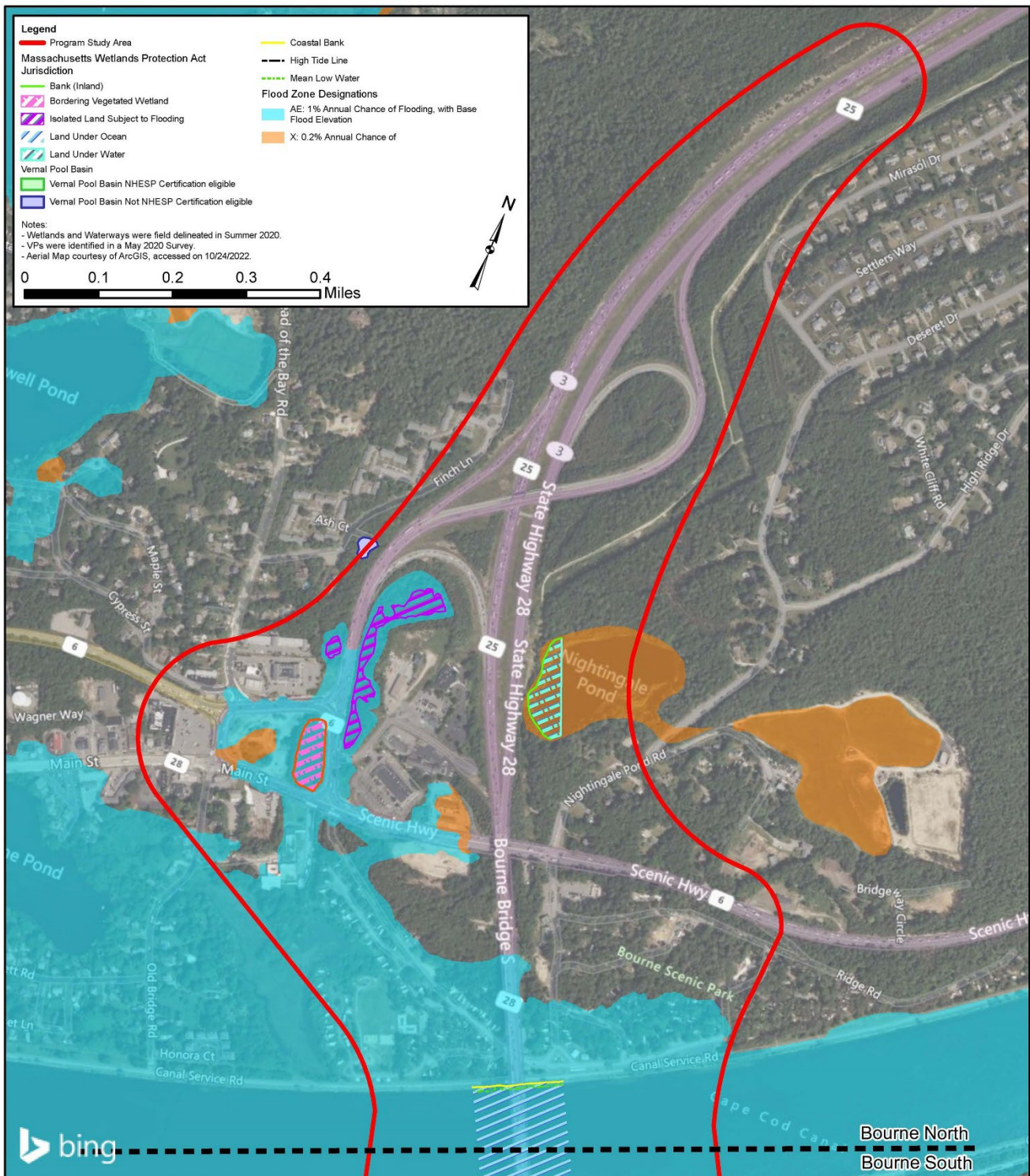


Figure 5-1. Wetlands and Waterways in the Bourne North Program Study Area

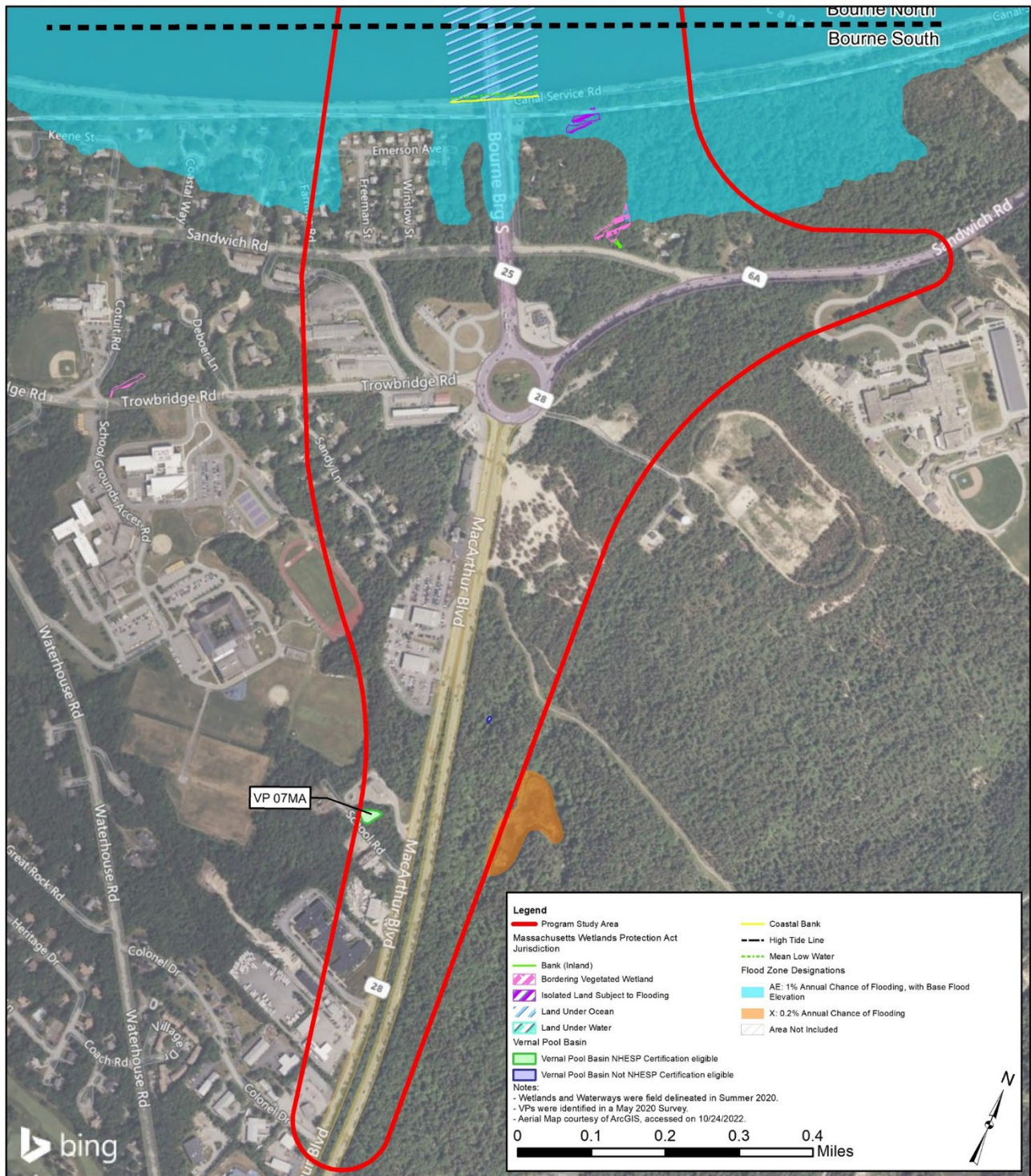
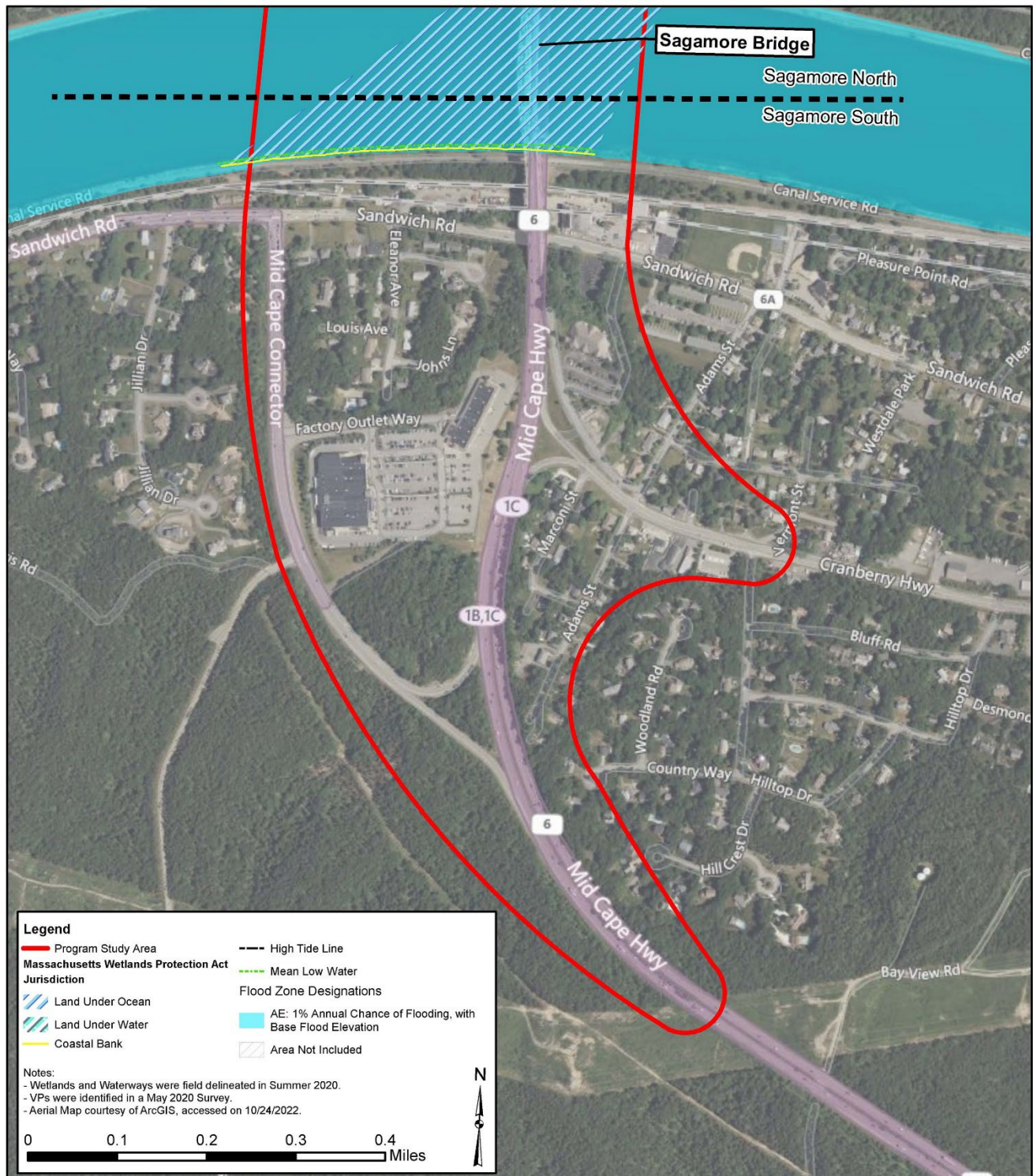


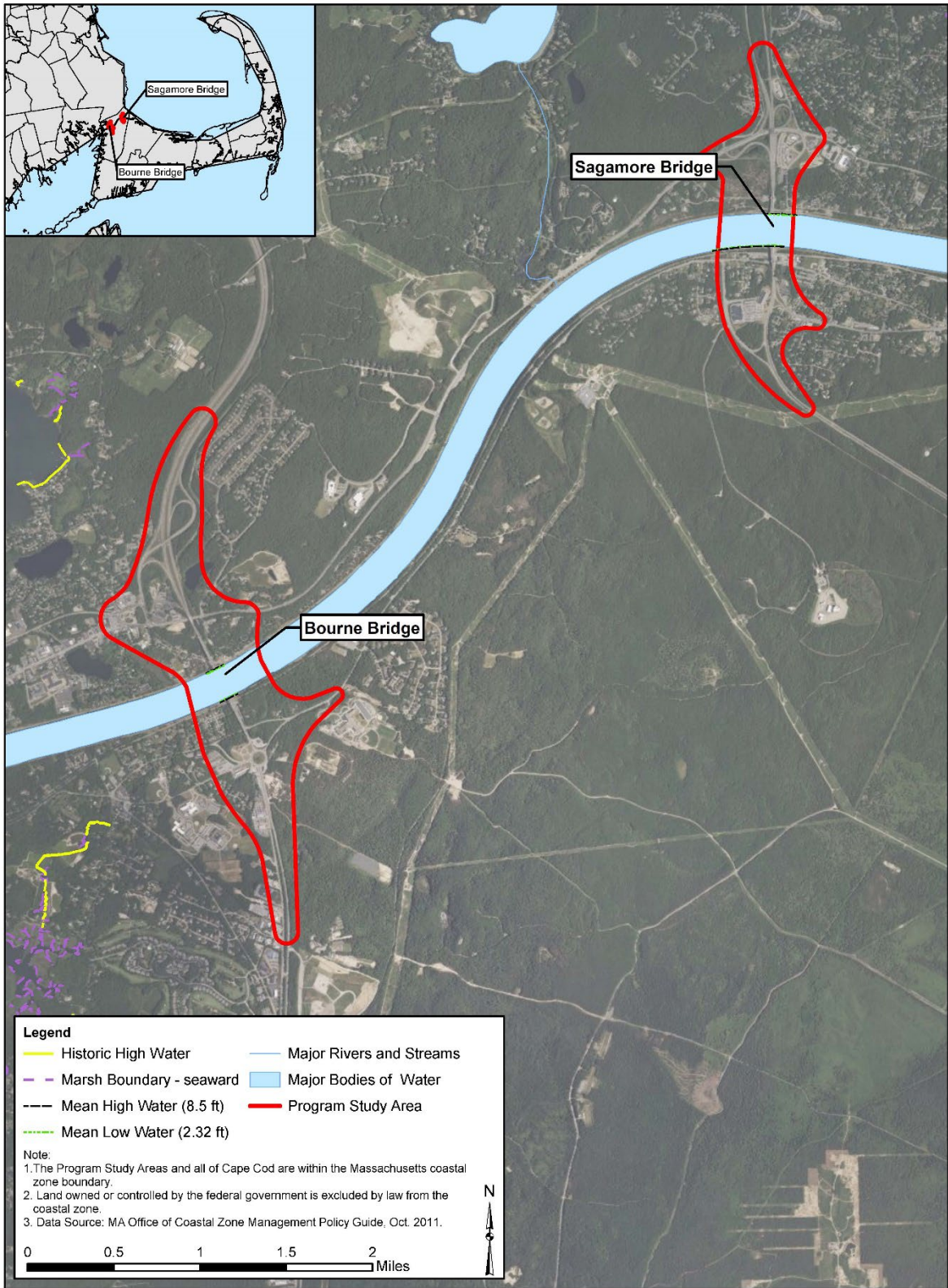
Figure 5-2. Wetlands and WaterMA in the Bourne South Program Study Area







**Figure 5-4. Wetlands and Waterways in the Sagamore South Program Study Area**



**Figure 5-5. Coastal Resources in the Bourne and Sagamore Program Study Areas**

Massachusetts General Law (MGL) Chapter 91 regulates tidelands and other waterways throughout the Commonwealth with a focus on protecting and promoting public use. As submerged land subject to tidal action, Cape Cod Canal meets the definition of flowed tidelands per the Massachusetts Waterways regulations (310 CMR 9.00).

MassDOT filed an Abbreviated Notice of Resource Area Delineation (ANRAD) with the Bourne Conservation Commission in January 2022 to confirm the boundaries of the delineated resource areas. The Bourne Conservation Commission approved the ANRAD and issued an Order of Resource Area Delineation (ORAD) on May 5, 2022.

A field survey to evaluate potential vernal pool habitat was conducted in accordance with the Massachusetts Natural Heritage and Endangered Species Program's (NHESP) 2009 Guidelines for the Certification of Vernal Pool Habitat (NHESP VP Guidelines). During May 13–15, 2020, meander surveys were conducted within the Program Study Areas and adjacent areas. The surveys were part of the preliminary Program design to identify vernal pools that meet the physical characteristics as defined by the NHESP and U.S. Army Corps of Engineers (USACE) in their General Permits for the Commonwealth of Massachusetts. Surveys also evaluated the presence of obligate and facultative vernal pool species as specified in the NHESP VP Guidelines to determine eligibility for certification by NHESP.

The vernal pool survey documented nine vernal pools with at least one egg mass of an obligate species within the vicinity of the Program Study Areas. Of these, two vernal pools (not mapped by NHESP), 08MA located south the Sagamore Bridge (outside of the Program Study Area) and 07MA located south of the Bourne Bridge (within the Program Study Area), were determined to be eligible for NHESP certification. Two vernal pools, 05DN/Certified Vernal Pool (CVP) #555 and 04MA/CVP #556, were previously certified by the NHESP. Vernal pool 04MA/CVP #556 continued to meet NHESP certification criteria, while vernal pool 05DN/CVP #555 contained fish and would have been considered ineligible for certification by the NHESP at the time of the 2020 field survey. The other five of the nine vernal pools did not contain sufficient evidence of obligate or facultative vernal pool species at the time of the survey to meet NHESP certification criteria. Figures 5-1 through 5-4 show the locations of the four documented vernal pools within and directly adjacent to the Program Study Area.

Potential Vernal Pools (PVP) mapped by NHESP were surveyed but contained fish and were artificially constructed and would not meet NHESP certification criteria. Other possible vernal pool habitat identified within several wetland areas did not contain evidence of facultative or obligate vernal pool species, and a few areas within Joint Base Cape Cod and existing stormwater management areas were inaccessible during the field survey, i.e., fenced.

## 5.2 Preliminary Impact Assessment

Section 5.2 presents potential impacts to wetland resource areas within the Program Study Areas associated with the Program. Preliminary permanent impacts to wetland resource areas were calculated

based on an overlay of the Program's bridge replacement structures (including profile and cross section), fully offline inboard mainline alignment location, center span length, paired with the interchange approach alternatives over the delineated resource boundaries. Section 2.1 shows schematics of the preferred mainline alignment location (Figures 2-3 and 2-4) and center span length (Figure 2-6). The ten interchange approach alternatives are presented in Section 2.1.5 and summarized in Table 2-1. Figures 2-7 through 2-16 in Section 2.1 present schematics of the preferred interchange approach alternatives.

Preliminary floodplain impacts were calculated using a Federal Emergency Management Agency (FEMA) Base Flood Elevation (BFE) of 14-foot NAVD88 for impacts associated with the Sagamore Bridge replacement structure, and BFE 16 feet NAVD88 for impacts associated with the Bourne Bridge replacement structure.<sup>15</sup>

Based on conceptual design, bridge replacements at both crossings would permanently impact Land Subject to Coastal Storm Flowage (LSCSF), due to the installation of bridge piers within the rip rap portions of Cape Cod Canal.

Based on conceptual design, MassDOT has identified potential impacts associated with the Bourne and Sagamore interchange approach alternatives. It is anticipated that the Bourne crossing interchange approach alternatives would not result in additional impacts to WPA-regulated coastal resources, including LSCSF, nor would they result in impacts to bank, land under water, isolated vegetated wetlands, Bordering Land Subject to Flooding (BLSF), or Riverfront area. It is anticipated that the Bourne crossing interchange approach alternatives would result in permanent and temporary impacts to Isolated Land Subject to Flooding (ILSF). Impacts to the buffer zones of regulated resources could occur with the interchange approach alternatives.

MassDOT is evaluating the need for design refinements to Belmont Circle, located west of the Route 28 approach to the Bourne Bridge. Improvements associated with Belmont Circle could result in impacts to bordering vegetated wetlands (BVW). Design refinements to Belmont Circle and potential impacts to BVW will be identified and assessed in the DEIR.

It is anticipated that the Sagamore crossing interchange approach alternatives would not result in impacts to any WPA-regulated inland or coastal resources except for LSCSF. There are no resources with jurisdictional buffer zones within the Sagamore Program Study Area; therefore, no buffer zone impacts are anticipated.

---

<sup>15</sup> The Base Flood Elevations used as the estimating elevation for Land Subject to Coastal Storm Flowage (LSCSF) impacts were identified on the FEMA Flood Insurance Program Maps for Barnstable County along the Cape Cod Canal within the Program Study Areas.

Tables 5-1 and 5-2 present potential impacts to WPA-jurisdictional resources and buffer zones in the Bourne Program Study Area. Table 5-3 presents potential impacts to WPA-jurisdictional resources in the Sagamore Program Study Area.

**Table 5-1. Bourne Program Study Area - Estimated Impacts**

WPA Jurisdictional Resources	Bourne Crossing Interchange Approach Alternatives				
	Bourne North Crossing			Bourne South Crossing	
	Northbound On-Ramp	Single Exit Partial Interchange	Directional Interchange	Diamond Interchange	Single-Point Interchange
Land Subject to Coastal Storm Flowage (cf)	85,000	85,000	85,000	73,000	73,000
Isolated Land Subject to Flooding (sf)	5,200	3,600	3,400	0	0

**Table 5-2. Bourne Program Study Area - Estimated Buffer Zone Impacts**

WPA Jurisdictional Resource	Bourne Crossing Interchange Approach Alternatives				
	Bourne North Crossing			Bourne South Crossing	
	Northbound On-Ramp	Single Exit Partial Interchange	Directional Interchange	Diamond Interchange	Single-Point Interchange
Buffer Zone (sf)	38,000	38,000	38,000	32,000	23,000

**Table 5-3. Sagamore Program Study Area – Estimated Impacts**

WPA Jurisdictional Resources	Sagamore Crossing Interchange Approach Alternatives				
	Sagamore North Crossing		Sagamore South Crossing		
	Similar to Existing Configuration	Direct Connection to State Road	Similar to Existing Configuration with Cranberry Highway Extension	Similar to Existing Configuration	Westbound On-Ramp Under Route 6
Land Subject to Coastal Storm Flowage (cf)	70,000	70,000	70,000	70,000	70,000

It is anticipated that the WPA-jurisdictional ILSF impacts identified in Table 5-1 would be classified as federally jurisdictional Waters of the United States (WOTUS), pursuant to the United States Clean Water Act (CWA).

MassDOT has also identified potential impacts to federally protected wetland resources that do not meet the regulatory criteria for WPA-jurisdiction associated with Bourne Crossing Interchange Approach Alternatives BS-2 and BS-2.2. These features were characterized as small, isolated depressions that do not have the potential to confine standing water with a volume of at least 0.25 acre-feet, required to be WPA-jurisdictional as ILSF pursuant to 310 CMR 10.57(2)(b)1. These features do not border on creeks, rivers, streams, ponds, or lakes, required to be WPA-jurisdictional as BLSF pursuant to 310 CMR 10.55(2)(a). It is anticipated that both Interchange Approach Alternatives BS-2 and BS-2.2 would independently result in approximately 3,700 sf of impacts to these federal jurisdictional resources areas that do not meet the criteria for WPA jurisdiction.

### 5.3 Next Steps

MassDOT will refine permanent and temporary impacts to protected wetland resource areas, including the potential to impact Nightingale Pond, as design advances. A detailed analysis of impacts to jurisdictional resource areas, discussion of measures to avoid or minimize impacts, and identification of mitigation measures will be provided in the DEIR.

As recommended by the U.S. Environmental Protection Agency (EPA) in its initial review of the MRER/EA (provided as Attachment 6.4), the DEIR will include a qualitative and quantitative assessment of stormwater management, including an assessment of how the Program will comply with Massachusetts stormwater regulations and regulatory performance standards.

### 5.4 Consistency with Coastal Zone Management Policies

The Office of Coastal Zone Management (CZM) reviewed the USACE MRER/EA to ensure consistency with CZM enforceable Program policies. The MRER/EA indicated that the proposed bridge replacement would have no significant impact on the coastal environment; further, the Program would preserve all coastal resources including the immediate waterfront and waterway for both recreational and vessel-related activities. In a November 26, 2019, letter to the USACE, provided as Attachment 6.5, CZM concurred with the USACE's determination that the Program as proposed is consistent with CZM's enforceable program policies. MassDOT will continue coordination with CZM as design of the Cape Cod Bridges Program advances.

The following sections provide an update on the effects of the Cape Cod Bridges Program on coastal resources or uses. As described within, the Cape Cod Bridges Program is consistent with the CZM's coastal program policies.

#### 5.4.1 Coastal Hazards Policies

##### 5.4.1.1 Coastal Hazards Policy #1

Policy: *Preserve, protect, restore, and enhance the beneficial functions of storm damage prevention and flood control provided by natural coastal landforms, such as dunes, beaches, barrier beaches, coastal banks, land subject to coastal storm flowage, salt marshes, and land under the ocean.*

Consistency: The existing Bourne and Sagamore highway bridges are located within Zone AE (1 percent annual chance of flooding, with BFE). The existing bridge footings are located within the waterway, below mean high water. The replacement bridges would be located adjacent to and inboard of the existing bridges, also within Zone AE. The replacement bridge footings are proposed to be in rip rap above the low tide line of the canal and outside of the navigation channel. Additionally, design of the replacement bridges would account for relative sea level rise (SLR). To maintain a 135-foot vertical navigational clearance, MassDOT proposes to increase the height of the bridges by approximately three feet.

#### 5.4.1.2 Coastal Hazards Policy #2

Policy: *Ensure that construction in water bodies and contiguous land areas will minimize interference with water circulation and sediment transport. Flood or erosion control projects must demonstrate no significant adverse effects on the project site or adjacent or downcoast areas.*

Consistency: The proposed replacement bridge piers would be set in the rip rap and above the low tide line of the canal; well outside the navigation channel to minimize construction within waterbodies. All actions supporting the proposed program, including any future repair or maintenance activities, would be coordinated with affected resource agencies during the design and construction to ensure minimization of impacts to water circulation and sediment transport. Additionally, a Stormwater Management Plan would be developed, and BMPs would be employed to minimize and contain any sediment runoff during construction.

#### 5.4.1.3 Coastal Hazards Policy #3

Policy: *Ensure that state and federally funded public works projects proposed for location within the coastal zone will:*

- *Not exacerbate existing hazards or damage natural buffers or other natural resources.*
- *Be reasonably safe from flood and erosion-related damage.*
- *Not promote growth and development in hazard-prone or buffer areas, especially in velocity zones and Areas of Critical Environmental Concern.*
- *Not be used on Coastal Barrier Resource Units for new or substantial reconstruction of structures in a manner inconsistent with the Coastal Barrier Resource/Improvement Acts.*

Consistency: The proposed work would be designed to avoid, minimize, and mitigate impacts to adjacent natural resources. The Program would provide stormwater management strategies to cost-effectively achieve Massachusetts water quality goals. Replacement of the Bourne and Sagamore bridges would not exacerbate any of the abovementioned existing hazards and would be designed to ensure resiliency to flooding events and erosion. The Program would add approximately three feet to the existing bridge vertical clearance to account for sea level rise and storm surges. The Program would not promote development in hazard-prone areas is not located within Coastal Barrier Resource Units. Approximately 28 acres of the Sagamore Program Study Area occur within the Herring River Watershed ACEC. It is anticipated that proposed work within the ACEC would occur within areas previously disturbed by highway construction.



#### 5.4.1.4 Coastal Hazards Policy #4

Policy: *Prioritize acquisition of hazardous coastal areas that have high conservation and/or recreation values and relocation of structures out of coastal high-hazard areas, giving due consideration to the effects of coastal hazards at the location to the use and manageability of the area.*

Consistency: This policy is not applicable.

### 5.4.2 Energy Policies

#### 5.4.2.1 Energy Policy #1

Policy: *For coastally dependent energy facilities, assess siting in alternative coastal locations. For non-coastally dependent energy facilities, assess siting in areas outside of the coastal zone. Weigh the environmental and safety impacts of locating proposed energy facilities at alternative sites.*

Consistency: This policy is not applicable.

#### 5.4.2.2 Energy Policy #2

Policy: *Encourage energy conservation and the use of renewable sources such as solar and wind power to assist in meeting the energy needs of the Commonwealth.*

Consistency: This policy is not applicable.

### 5.4.3 Growth Management Policies

#### 5.4.3.1 Growth Management Policy #1

Policy: *Encourage sustainable development that is consistent with state, regional, and local plans and supports the quality and character of the community.*

Consistency: As discussed in Section 3.2, the Program is consistent the development goals outlined in the Bourne Local Comprehensive Plan. The proposed work would avoid, minimize, and mitigate impacts to adjacent residences, businesses, natural resources, open space, and historic and archaeological resources to the maximum extent practicable. As such, MassDOT would facilitate the development and operation of a Program that would not reduce the quality or character of the surrounding community.

#### 5.4.3.2 Growth Management Policy #2

Policy: *Ensure that state and federally funded infrastructure projects in the coastal zone primarily serve existing developed areas, assigning highest priority to projects that meet the needs of urban and community development centers.*

Consistency: The Program would serve to meet the needs of urban and community development centers by providing a more efficient and safe system for vehicular transport across the Cape Cod Canal. The Bourne and Sagamore Bridges provide the only vehicular access to 15 towns and nearly 229,000 full time residents and millions of annual visitors to Cape Cod. The bridges also provide access to eight offshore island municipalities through the ferry terminals located on Cape Cod. Safe replacement bridges would supply the only access for residents, commuters, and visitors.

### 5.4.3.3 Growth Management Policy #3

Policy: *Encourage the revitalization and enhancement of existing development centers in the coastal zone through technical assistance and financial support for residential, commercial, and industrial development.*

Consistency: This policy is not applicable.

## 5.4.4 Habitat Policies

### 5.4.4.1 Habitat Policy #1

Policy: *Protect coastal, estuarine, and marine habitats—including salt marshes, shellfish beds, submerged aquatic vegetation, dunes, beaches, barrier beaches, banks, salt ponds, eelgrass beds, tidal flats, rocky shores, bays, sounds, and other ocean habitats—and coastal freshwater streams, ponds, and wetlands to preserve critical wildlife habitat and other important functions and services including nutrient and sediment attenuation, wave and storm damage protection, and landform movement and processes.*

Consistency: The bridge replacement structures would involve the removal of piers from within the waterway, replacing them with piers outside the waterway and within the rip rap, reducing the overall structural footprint in the Canal. Impacts to the waterway and Essential Fish Habitat during removal activities would be temporary and would reduce the in-water footprint of the bridge structures. MassDOT would use BMPs during the entire removal process to minimize impacts to the surrounding environment.

### 5.4.4.2 Habitat Policy #2

Policy: *Advance the restoration of degraded or former habitats in coastal and marine areas.*

Consistency: This policy is not applicable.

## 5.4.5 Ocean Resources Policies

### 5.4.5.1 Ocean Resources Policy #1

Policy: *Support the development of sustainable aquaculture, both for commercial and enhancement (public shellfish stocking) purposes. Ensure that the review process regulating aquaculture facility sites (and access routes to those areas) protects significant ecological resources (salt marshes, dunes, beaches, barrier beaches, and salt ponds) and minimizes adverse effects on the coastal and marine environment and other water-dependent uses.*

Consistency: This policy is not applicable.

### 5.4.5.2 Ocean Resources Policy #2

Policy: *Except where such activity is prohibited by the Ocean Sanctuaries Act, the Massachusetts Ocean Management Plan, or other applicable provision of law, the extraction of oil, natural gas, or marine minerals (other than sand and gravel) in or affecting the coastal zone must protect marine resources, marine water quality, fisheries, and navigational, recreational, and other uses.*

Consistency: This policy is not applicable.

#### 5.4.5.3 Ocean Resources Policy #3

Policy: *Accommodate offshore sand and gravel extraction needs in areas and in ways that will not adversely affect marine resources, navigation, or shoreline areas due to alteration of wave direction and dynamics. Extraction of sand and gravel, when and where permitted, will be primarily for the purpose of beach nourishment or shoreline stabilization.*

Consistency: This policy is not applicable.

### 5.4.6 Ports and Harbors Policies

#### 5.4.6.1 Ports and Harbors Policy #1

Policy: *Ensure that dredging and disposal of dredged material minimize adverse effects on water quality, physical processes, marine productivity, and public health and take full advantage of opportunities for beneficial re-use.*

Consistency: The Cape Cod Bridges Program could require dredging within Cape Cod Canal for removal of the existing bridge piers. The exact means and methods of pier removal will be identified as design advances. As feasible, MassDOT proposes to use Best Management Practices minimize adverse effects on the waterway during pier removal. In-water work would be conducted in coordination with the applicable resource agencies to avoid, minimize, and mitigate impacts to protected resources within and adjacent to the canal.

#### 5.4.6.2 Ports and Harbors Policy #2

Policy: *Obtain the widest possible public benefit from channel dredging and ensure that Designated Port Areas and developed harbors are given highest priority in the allocation of resources.*

Consistency: The Program would not deepen or widen the canal. The Program Study Areas are not located within a Designated Port Area.

#### 5.4.6.3 Ports and Harbors Policy #3

Policy: *Preserve and enhance the capacity of Designated Port Areas to accommodate water-dependent industrial uses and prevent the exclusion of such uses from tidelands and any other DPA lands over which an EEA agency exerts control by virtue of ownership or other legal authority.*

Consistency: This policy is not applicable. The Program Study Areas are not located within a Designated Port Area.

#### 5.4.6.4 Ports and Harbors Policy #4

Policy: *For development on tidelands and other coastal waterways, preserve and enhance the immediate waterfront for vessel-related activities that require sufficient space and suitable facilities along the water's edge for operational purposes.*

Consistency: The Program would preserve the immediate waterfront for vessel-related activities and is therefore consistent with this policy.

#### 5.4.6.5 Ports and Harbors Policy #5

Policy: *Encourage, through technical and financial assistance, expansion of water-dependent uses in Designated Port Areas and developed harbors, re-development of urban waterfronts, and expansion of physical and visual access.*

Consistency: This policy is not applicable.

#### 5.4.7 Protected Areas Policies

##### 5.4.7.1 Protected Areas Policy #1

Policy: *Preserve, restore, and enhance coastal Areas of Critical Environmental Concern, which are complexes of natural and cultural resources of regional or statewide significance.*

Consistency: The Herring River Watershed ACEC overlaps with the northwestern corner of the Sagamore Program Study Area. It is anticipated that proposed work within the ACEC would occur within areas previously disturbed by highway construction.

##### 5.4.7.2 Protected Areas Policy #2

Policy: *Protect state designated scenic rivers in the coastal zone.*

Consistency: This policy is not applicable; there are no state designated scenic rivers in the Program Study Areas.

##### 5.4.7.3 Protected Areas Policy #3

Policy: *Ensure that proposed developments in or near designated or registered historic places respect the preservation intent of the designation and that potential adverse effects are minimized.*

Consistency: In coordination with the Massachusetts Historical Commission, MassDOT will identify stipulations in the Memorandum of Agreement to mitigate the loss of the historic Bourne and Sagamore bridges. Additionally, in coordination with historic stakeholders, including the public, MassDOT is developing the design of the replacement bridges to minimize adverse effects to the National Register of Historic Place (NRHP)-eligible Cape Cod Canal District.

#### 5.4.8 Public Access Policies

##### 5.4.8.1 Public Access Policy #1

Policy: *Ensure that development (both water-dependent or nonwater-dependent) of coastal sites subject to state waterways regulation will promote general public use and enjoyment of the water's edge, to an extent commensurate with the Commonwealth's interests in flowed and filled tidelands under the Public Trust Doctrine.*

Consistency: The Program would minimize impacts to open space, including the USACE-leased property and the Town of Bourne Scenic Park, to the greatest extent practicable. Impacts could include permanent operational impacts, temporary construction-related impacts, or both permanent and temporary impacts. The Program proposes to provide separated shared-use paths on the replacement

bridges, which would provide safe connections to the local roadway network and recreational areas adjacent to the canal.

#### 5.4.8.2 Public Access Policy #2

*Policy: Improve public access to existing coastal recreation facilities and alleviate auto traffic and parking problems through improvements in public transportation and trail links (land- or water-based) to other nearby facilities. Increase capacity of existing recreation areas by facilitating multiple use and by improving management, maintenance, and public support facilities. Ensure that the adverse impacts of developments proposed near existing public access and recreation sites are minimized.*

Consistency: The Program would expand coastal recreational facilities through provision of separated shared-use paths on the replacement bridges. The shared-use paths would provide safe connections to the local roadway network and recreation areas adjacent to the canal. It is anticipated that proposed work would result in both permanent and temporary impacts to recreational areas along the canal. All impacts to recreational facilities would be minimized and mitigated to the maximum extent practicable.

#### 5.4.8.3 Public Access Policy #3

*Policy: Expand existing recreation facilities and acquire and develop new public areas for coastal recreational activities, giving highest priority to regions of high need or limited site availability. Provide technical assistance to developers of both public and private recreation facilities and sites that increase public access to the shoreline to ensure that both transportation access and the recreation facilities are compatible with social and environmental characteristics of surrounding communities.*

Consistency: The Program would expand recreational facilities through the provision of shared-use paths on the proposed replacement bridges. The Program would result in operational and temporary impacts to recreational areas adjacent to the Canal. In coordination with USACE and FHWA, MassDOT would coordinate with the Town of Bourne to develop mitigation measures to compensate for impacts and ensure continued public access to compatible recreational resources.

### 5.4.9 Water Quality Policies

#### 5.4.9.1 Water Quality Policy #1

*Policy: Ensure that point-source discharges and withdrawals in or affecting the coastal zone do not compromise water quality standards and protect designated uses and other interests.*

Consistency: A Stormwater Management Plan would be developed during design in conformance with the standards established by MassDEP Stormwater Management Regulations (310 CMR 10.05).

#### 5.4.9.2 Water Quality Policy #2

*Policy: Ensure the implementation of nonpoint source pollution controls to promote the attainment of water quality standards and protect designated uses and other interests.*

Consistency: MassDOT would use BMPs, including but not limited to sedimentation and erosion controls, water quality swales, deep sump catch basins, and detention basins, to control non-point pollution sources during construction and, as needed, as an operational measure

### 5.4.9.3 Water Quality Policy #3

Policy: *Ensure that subsurface waste discharges conform to applicable standards, including the siting, construction, and maintenance requirements for on-site wastewater disposal systems, water quality standards, established Total Maximum Daily Load limits, and prohibitions on facilities in high-hazard areas.*

Consistency: This policy is not applicable.

## 6 Transportation Section

This section describes the existing transportation network in and near the Program Study Areas and presents potential impacts to transportation facilities due to the Program. Figure 6-1 shows the Program Study Areas within the larger regional transportation setting. Figures 6-2 and 6-3 show the vehicular and the bicycle transportation network within the Bourne and Sagamore Program Study Areas.

### 6.1 Existing Conditions

#### 6.1.1 Bourne and Sagamore Bridges

Bourne Bridge is a 7-span steel truss bridge of 2,684 feet connecting Route 28 in the south with Route 25 in the north. The arched center span is 616 feet long, flanked by truss spans that are each 396 feet long, and two additional approach spans on each side. The overall deck width is 487 feet. The bridge has concrete column piers and abutments. Sagamore Bridge is a 3-span steel truss bridge of 1,833 feet connecting Route 6 (Mid Cape Highway) in the south with Route 3 in the north. It is almost identical to the Bourne Bridge, with a 616-foot center span flanked by 396-foot truss spans supported by concrete abutments. The overall deck width is 487 feet. Both bridges provide a highway of four 10-foot-wide travel lanes, two in each direction, with one 6-foot sidewalk along the east side and a two-foot safety curb along the west side. The two four-lane high-level fixed-span highway bridges, with a 135-foot mean high water (MHW) vertical clearance and a 500-foot horizontal clearance, were authorized by Congress in 1933. The bridges opened to traffic in 1935.

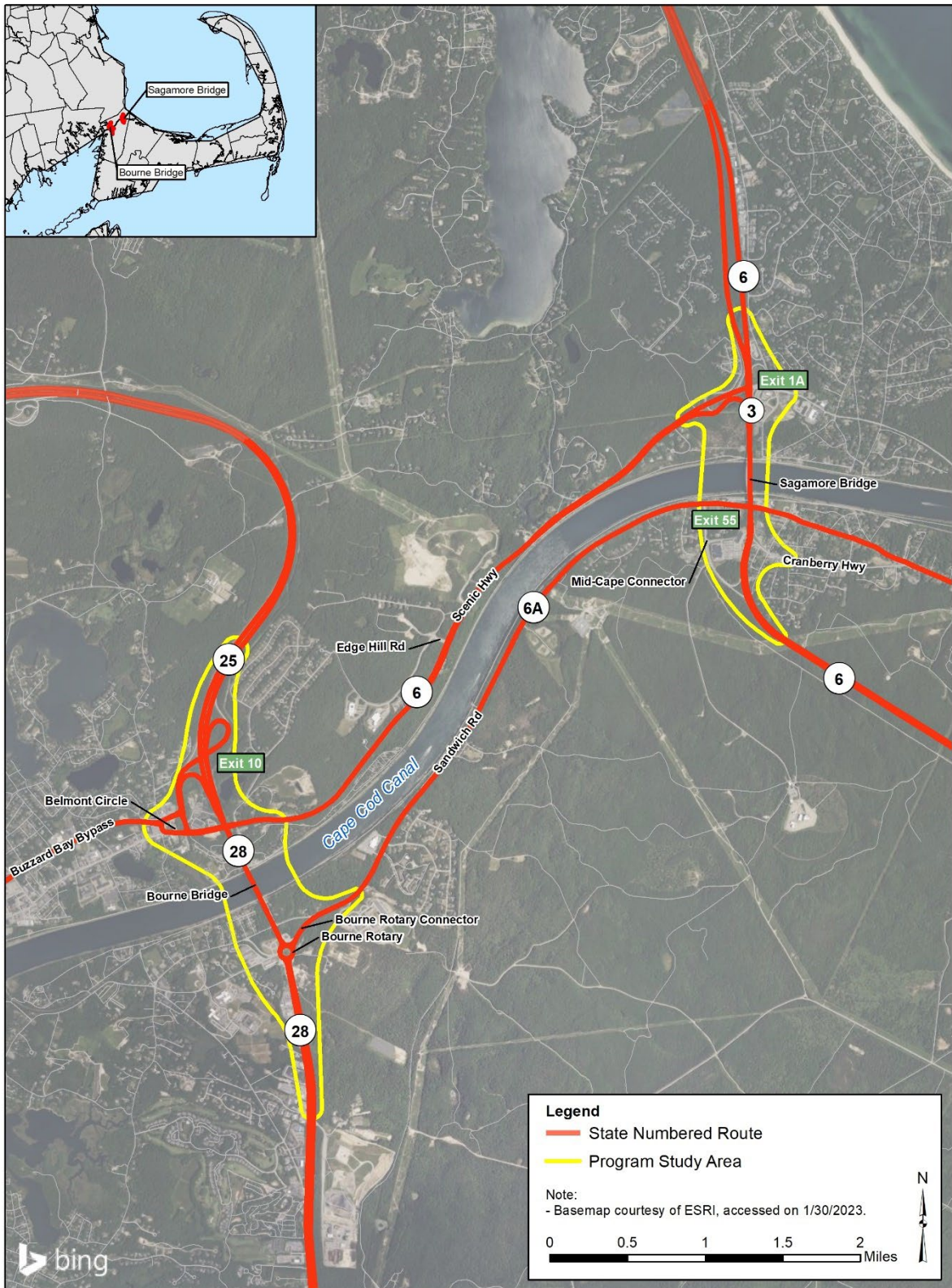
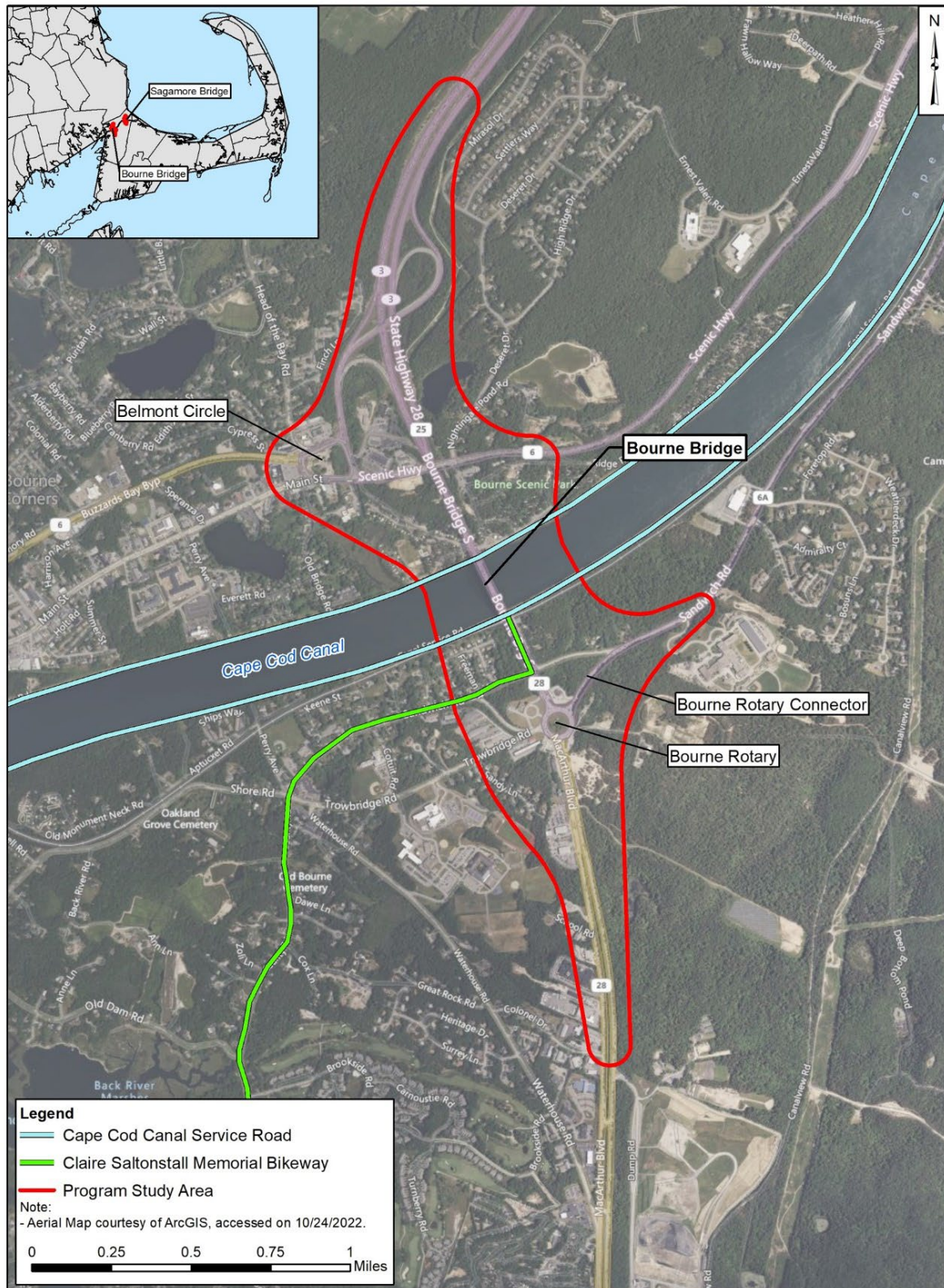
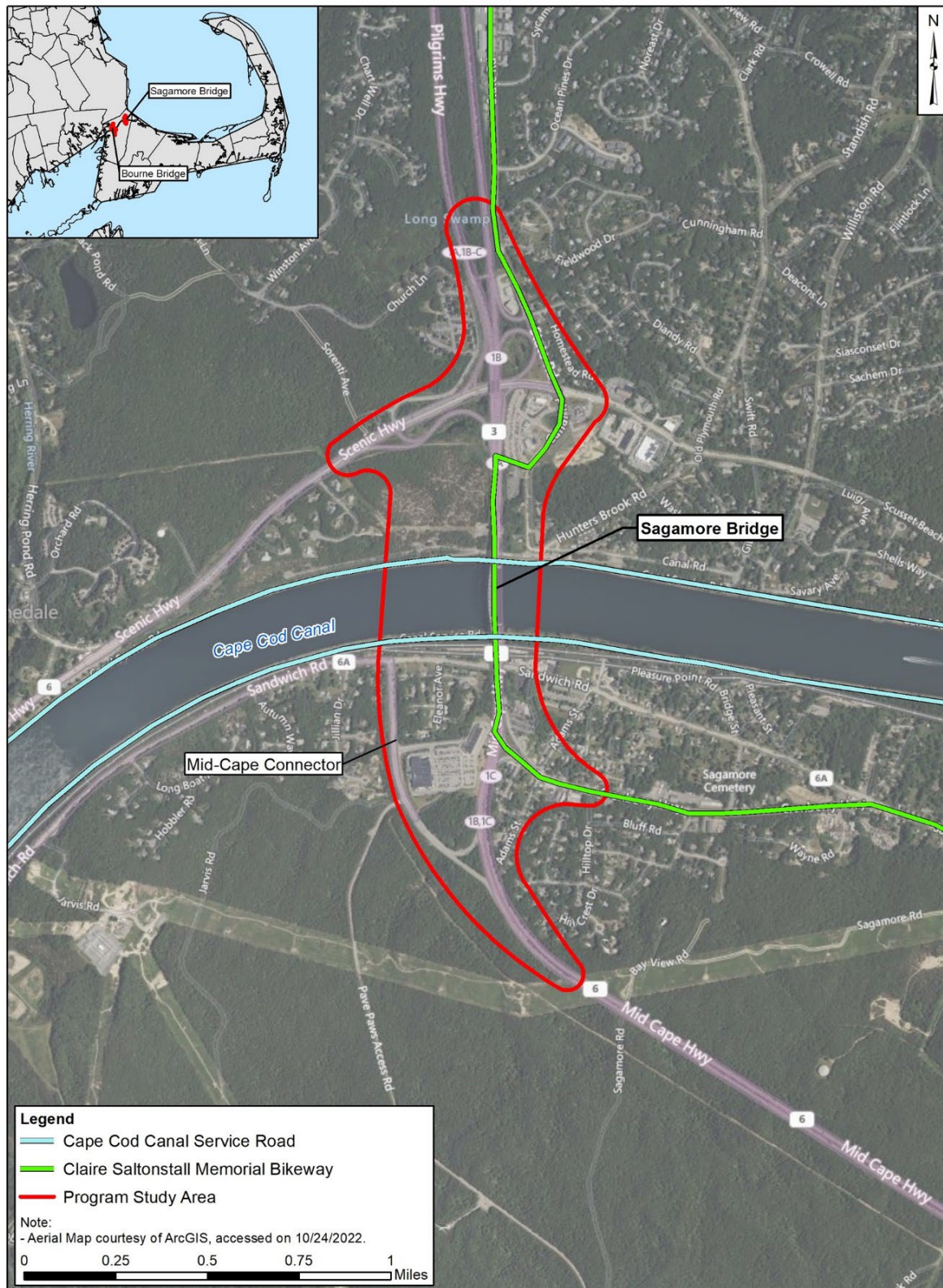


Figure 6-1. Cape Cod Bridges Program Regional Transportation Network



**Figure 6-2. Vehicular and Bicycle Transportation Network in the Bourne Program Study Area**





**Figure 6-3. Vehicular and Bicycle Transportation Network in the Sagamore Program Study Area**

After nearly 90 years of continuous traffic use, both steel truss bridges have deteriorated over time and are now beyond their functional service lives. Based on latest information available from a routine inspection conducted by USACE in October 2020,<sup>16</sup> the Bourne Bridge was classified as structurally deficient due to the poor condition of the bridge superstructure. Although, the Sagamore Bridge was not classified as structurally deficient as of the latest available inspection conducted by the USACE in September 2021<sup>17</sup>, individual bridge components were noted to be in poor condition including fracture critical gusset plates and other connection plates. Due to their deteriorated structural condition, both bridges require frequent maintenance with extended lane closures that are highly disruptive to traffic crossing Cape Cod Canal. In addition to their escalating maintenance needs, these nearly 90-year-old Bourne and Sagamore bridges are functionally obsolete due to their narrow lane widths, lack of shoulders and medians, and inadequate pedestrian and bicycle access. As of the October 2020 and September 2021 inspections conducted by the USACE, it was also noted that the traffic safety features of the Bourne and Sagamore bridges, including the bridge railing, transitions, approach guardrails, and approach guardrail ends, do not conform to current AASHTO or MassDOT Specifications.

### **6.1.2 Major Highways in the Program Study Area**

Major highway corridors in the Sagamore Program Study Area include the Route 3/Sagamore Bridge/Route 6 corridor and the Route 25/Bourne Bridge/Route 28 corridor in the Bourne Program Study Area. These highways are all under MassDOT jurisdiction, while the Bourne and Sagamore bridges are federally owned and maintained by the USACE. Route 6 (Scenic Highway) and Sandwich Road connect these two corridors on the north and south sides of Cape Cod Canal, respectively.

#### **6.1.2.1 Route 3/Sagamore Bridge/Route 6 Corridor**

Route 3, a principal arterial roadway, provides the main highway connection from Boston and other points north to Cape Cod. From the “Braintree Split” (the I 93/Route 3 Interchange in Braintree) south to the Sagamore Bridge, Route 3 generally provides two 12-foot-wide travel lanes in each direction with an eight-foot shoulder separated by a grassed median. This configuration continues into the Program Study Area from the north at the Route 3/Route 3A Interchange Exit 3 (formerly Exit 2) in the Town of Bourne.

Approximately two miles south of the Route 3 Exit 2 at Herring Pond Road interchange, Route 3 passes through the “Sagamore Flyover” (Exit 1A, the interchange of Route 3 with Route 6/Scenic Highway). Approaching this interchange from the north, one of the two travel lanes in Route 3 southbound is dropped to allow travelers from Scenic Highway to merge onto Route 3 at Exit 1A, reinstating the second travel lane.

South of the Sagamore Rotary, the highway designation changes to Route 6 and immediately crosses Cape Cod Canal on the Sagamore Bridge. The cross section of the Sagamore Bridge includes two 10-foot

---

<sup>16</sup> TranSystems Corporation, Routine Inspection Report, Volume I of III; 2020 Routine Inspection of the Bourne Bridge over the Cape Cod Canal, February 2021.

<sup>17</sup> TranSystems Corporation, Routine Inspection Report, Volume I of III; 2021 Routine Inspection of the Sagamore Bridge over the Cape Cod Canal, January 2022.

travel lanes in each direction with no roadway shoulder or median. A 5-foot-wide sidewalk is present on the east side of the bridge. The sidewalk is separated from the roadway by a 12-inch-high granite curb. South of the Sagamore Bridge, Route 6 provides two travel lanes in each direction.

#### 6.1.2.2 Route 25/Bourne Bridge/Route 28 Corridor

Route 25 provides freeway access from the ends of both I-195 and I-495 to the Bourne Bridge. Route 25, which is functionally classified as a principal arterial roadway, provides three 12-foot travel lanes with an eight-foot shoulder in each direction separated by a 90-foot grassed median.

At the Route 25/Route 6 (Scenic Highway) Interchange in Bourne, the highway designation changes to Route 28 and immediately crosses Cape Cod Canal on the Bourne Bridge. The cross section of the Bourne Bridge includes two 10-foot travel lanes in each direction with no roadway shoulder or median. A five-foot wide sidewalk is present on the west side of the bridge. The sidewalk is separated from the roadway by a 12-inch-high granite curb. Continuing south from the Bourne Bridge is the Bourne Rotary, which handles traffic from several roadways, including Route 28, Sandwich Road, and Trowbridge Road.

Route 28 is a principal arterial roadway. Within the study area, it comprises two 12-foot travel lanes in each direction with a 10-foot shoulder separated by a 70-foot forested median. Route 28 provides at-grade access to roadways to the west and has turn around ramps every 0.5 miles.

#### 6.1.2.3 Route 6 (Scenic Highway)

Route 6 (Scenic Highway) is a principal arterial roadway under MassDOT jurisdiction that extends along the north side of Cape Cod Canal from Route 3 at the Sagamore Interchange and continues to the west approximately 3.5 miles to Belmont Circle in Bourne. Scenic Highway provides a connection between the Sagamore Bridge and the Bourne Bridge.

Scenic Highway is signed as an east-west roadway but follows a southwest-northeast alignment through the Program Study Area. Scenic Highway generally provides two lanes in each direction within the Program Study Area. Traveling west from the Sagamore Bridge for approximately one-mile, the roadway is approximately 84-foot-wide consisting of two 12-foot travel lanes in each direction with a 16-foot-wide median and 10-foot-wide shoulders. No marked bicycles lanes or sidewalks are present. Traveling east from Belmont Circle, Scenic Highway is median divided to a signalized intersection with Nightingale Pond Road. Sidewalks are provided on both sides of Scenic Highway between Belmont Circle and Nightingale Pond Road. MassDOT is proposing improvements, including adding shoulders and a center median, to a 1.5-mile section of Scenic Highway between Nightingale Pond Road and Edge Hill Road (MassDOT File No. 606082).

#### 6.1.2.4 Sandwich Road

Sandwich Road is an urban principal arterial roadway under MassDOT jurisdiction that extends east-west for approximately 4.7 miles, parallel to the south side of the canal, from the Route 6A/Route 130 intersection to a four-way intersection with Shore Road, County Road, and Trowbridge Road in Bourne center.

Sandwich Road is generally 22- to 24-foot-wide, consisting of one 11- or 12-foot-wide lane in each direction with little or no roadway shoulder. No marked bicycle lanes or sidewalks are present. Sandwich Road passes under Route 6 at the Sagamore Bridge and provides access to Route 6 eastbound via the Mid-Cape Connector in Bourne and Route 3 via Cranberry Highway. At its western end, Sandwich Road provides access to either Routes 25 or 28 via the Bourne Rotary. An unsignalized left-turn lane is provided at the entrance road to the Upper Cape Cod Regional Technical School from the east, 0.4 miles east of the Bourne Rotary.

### **6.1.3 Major Intersections in the Program Study Area**

Major intersections in the Program Study Area include Belmont Circle, Bourne Rotary, and Route 6 Exit 55 as they lead motorists directly to and from Cape Cod via the Bourne and Sagamore bridges. Since each of these principal intersections suffers from substandard design features and high peak period traffic volumes, they are the main drivers of traffic congestion within the Program Study Area.

#### **6.1.3.1 Belmont Circle**

Belmont Circle is a rotary north of Cape Cod Canal immediately west of the Route 25 approach to the Bourne Bridge in Bourne. The roadway approaches to Belmont Circle include Scenic Highway, Main Street, Buzzards Bay Bypass, Head of the Bay Road, and the ramps to Route 25. The roadway approaches to Belmont Circle generally consist of a single 11-foot lane in each direction. Scenic Highway features two 11-foot lanes in each direction. The rotary itself generally features three 12-foot lanes. The rightmost lane is generally an auxiliary lane for entering and exiting vehicles and the left two lanes operate as circulating lanes around the rotary. MassDOT is proposing interim improvements to address safety issues through and around Belmont Circle (MassDOT Project No. 606900), including upgraded pavement markings and signage, installation of sidewalks and shared use paths and minor geometric modifications to better channelize traffic entering and exiting the rotary.

#### **6.1.3.2 Bourne Rotary**

The Bourne Rotary, immediately south of the Bourne Bridge, is a two-lane rotary with four approaches. These roadway approaches to the Bourne Rotary include Route 28 (on both the north and south sides of the Rotary), Trowbridge Road, and the Bourne Rotary Connector. Sandwich Road provides a roadway connection north of the rotary between Trowbridge Road (via Veterans Way) and the Bourne Rotary Connector. The Route 28 northbound and southbound approaches each consist of two lanes in each direction, which allows vehicles to travel to and from the rotary onto Route 28 from the inside and outside lanes. The Trowbridge Road eastbound approach consists of one lane in each direction. The Bourne Rotary Connector approach to the rotary consists of a single 16-foot lane in each direction.

MassDOT performed a Road Safety Audit (RSA) of the Bourne Rotary in 2013, which identified traffic safety issues related to signage, pavement markings, access management and site distance. MassDOT is proposing interim improvements to address these traffic operations and safety issues through the Bourne Rotary (MassDOT Project No. 610542), including upgraded pavement markings and signage, and minor adjustments to roadway geometry.

### 6.1.3.3 Route 6 Exit 55 Westbound

Immediately south of the Sagamore Bridge, Route 6 Exit 55 (formerly Exit 1C) provides westbound-only exit and entrance ramps to and from Cranberry Highway in Bourne. Exit 55 is the last westbound interchange on Route 6 prior to crossing Cape Cod Canal via the Sagamore Bridge. The geometry of Exit 55 is substandard and not in compliance with current MassDOT highway design standards. The deficiencies of Exit 55 include short acceleration and deceleration lanes, and steep grades approaching the Sagamore Bridge. High traffic volumes are common at the Exit 55 entrance ramp to Route 6 westbound because travelers often use Route 6A to Cranberry Highway to bypass congestion on Route 6 westbound.

### 6.1.4 Pedestrian and Bicycle Facilities

The existing Bourne and Sagamore bridges each provide a single, narrow (approximately 5-foot) sidewalk for pedestrian/bicycle use. The sidewalks have steep grades of between 6 and 6.5 percent that are not compliant with the Americans with Disabilities Act (ADA), are adjacent to high-speed traffic, and have poor connections to local facilities. Bicyclists are instructed to walk their bikes on the sidewalks as the only barrier between the sidewalk and the outside travel lane is a 12-inch-high granite curb.

Per MassDOT's Cape Cod Transportation Study, several of the approach roadways to the bridges lack accessible sidewalk connections. For example, pedestrians can only reach the Bourne Bridge sidewalk from the north on an unmarked sidewalk at the end of the Bridge approach via the end of a shopping area entrance drive. To reach the sidewalk at the south end of the Bourne Bridge, a pedestrian would need to enter the Bourne Rotary, a high-volume traffic circle that lacks sidewalks. Sidewalks that would connect the south end of Sagamore Bridge to either Cranberry Highway or Sandwich Road do not exist.

Route 6, Route 3, and Route 25, limited-access highways in the Program Study Areas, prohibit pedestrian access and do not have sidewalks. Other roadways in the Program Study Areas generally lack sidewalks, including Route 28, Buzzards Bay Bypass, Sandwich Road, Shore Road, County Road, and Scenic Highway (except in the immediate area of the Route 3 interchange).

The Cape Cod Canal Service Roads (Cape Cod Canal bike path), owned and maintained by the USACE as navigational support for the Cape Cod FNP, consist of 8-foot-wide shared use paths on both sides of the canal. The on-Cape (southern) side of the path is 6.5 miles with two roadway crossings. The off-Cape (northern) side is 7 miles long with seven roadway crossings. Currently, there are connection gaps between the pedestrian/bicycle access across the canal and the USACE-maintained 13.5-mile Cape Cod Canal service roads on both sides of the canal.

The Claire Saltonstall Memorial Bikeway<sup>18</sup> extends 165 miles from Boston to Provincetown and consists of a series of interconnected on-road segments and multi-use paths. The primary existing route segment in the town of Bourne runs along Route 3A, to Meetinghouse Lane, to the Sagamore Bridge, to Cranberry Highway, to Sandwich Road/Route 6A, to Route 130 (Figure 6-3). The Falmouth spur of the

---

<sup>18</sup> Also known as Mass Bike Route 1 and the Boston to Cape Cod Bikeway.

Saltonstall Bikeway runs from the Canal Service Road south under Bourne Bridge to Sandwich Road, to County Road, to the Falmouth town line.

Both the Cape Cod Commission and the Town of Bourne are active in advocating for improved connections with existing bicycle routes in the Program Study Areas. In a February 2015 report on recommended route revisions in Bourne for the Saltonstall Bikeway,<sup>19</sup> the Cape Cod Commission cited the high travel volumes and speeds on Sandwich Road/Route 6A and recommended alternatives to Route 6A where feasible. Additionally, the Commission recommended Adams Street as a preferred Sagamore Bridge-canal path connection, which would involve changing Adams Street from a two-way road to a one-way road to would allow for a two-way bike lane.

The Town of Bourne has evaluated the connectivity between town center areas and existing bicycle paths and routes, including identifying areas for sidewalks.<sup>20</sup> A recommended connector for the town within the Bourne Program Study Area includes Old Bridge Road which would connect the Cape Cod Canal bike path to Main Street, consisting of a 0.3-mile segment with share the road treatment options for signage and/or pavement markings. Additionally, the Cape Cod Commission has identified proposed improvements to existing bicycling facilities to create a Cape-wide bicycle route network. Upper Cape projects, which are proximate to or within the Bourne Program Study Area, include ongoing improvements at Belmont Circle, consisting of a shared use path and sidewalks; and a proposed 6.5-mile extension of the Shining Sea Bikeway in Falmouth to the USACE Cape Cod Canal service roads (Bourne Rail Trail Phase), consisting of a 10-foot-wide shared use path.

### **6.1.5 Cape Cod Canal Navigation**

Opening to vessel traffic in 1914, Cape Cod Canal is a sea-level waterway of 17.4 miles that connects Buzzards Bay and Cape Cod Bay. The land cut portion of the canal is 8.1 miles long, with a minimum depth of 32 feet and minimum width of 480 feet (with an average width of 540 feet at the water's surface); it extends from the village of Buzzards Bay in the town of Bourne to Cape Cod Bay in the town of Sandwich. Cape Cod Canal was constructed to provide a shorter and safer navigable intra-coastal shipping route from northern New England ports to other areas on the U.S. eastern seaboard. Part of the Atlantic Intracoastal Highway, the canal continues to serve as an important shipping route for domestic and foreign cargo, and is used extensively by recreational vessels, as well as military and fishing vessels.

According to the USACE, on an annual basis, Cape Cod Canal is used by more than 3,000 cargo vessels, at least 750 fishing vessels, approximately 150 to 200 military vessels, and more than 4,000 recreational vessels. The largest commercial vessels which transit the eastern seaboard, such as large oil tankers and containerships, typically have drafts too deep to use the canal; however, other large commercial vessels with drafts of 30 feet or less, such as cruise ships and automobile carriers, use the canal on a regular basis. The USACE is responsible for the movement of all vessels using Cape Cod Canal. Navigation on

---

<sup>19</sup> Cape Cod Commission. Clair Saltonstall Memorial Bikeway: Cape Cod Segment – Recommended Route Revisions, February 2015.

<sup>20</sup> Town of Bourne Open Space and Recreation Plan, February

Cape Cod Canal is supervised by the District Engineer, USACE, New England Division, per 33 CFR 207. The USACE's management of the Cape Cod Canal FNP includes the 32-foot-deep approach channel; the approximate 8.1-mile canal; two mooring basins, one at the head of Buzzards Bay and one on the north side of the canal; a 600-foot long jetty and 3,000-foot-long breakwater at the entrance to the canal from Cape Cod Bay; a dike in Bourne; and two basins for small boats, one west of the railroad bridge in Bourne and one on the north side of the canal near its entrance from Cape Cod Bay.

The USACE's Waterborne Commerce Statistics Center (WCSC) reports that all foreign and domestic freight traffic through Cape Cod Canal totaled approximately 6,715,000 short tons for calendar year (CY) 2019.<sup>21</sup> Domestic freight represented almost 89 percent of this total and foreign freight accounted for approximately 11 percent of the total. Most commodities consisted of petroleum and petroleum products (gasoline, kerosene, fuel oils), followed by chemical and related products. Of the 675 vessel trips in 2019, the majority were by non-self-propelled tanker or dry cargo vessels. Over 75 percent were traveling upbound (upstream; northerly), with the remainder traveling downbound (downstream; southerly). The WCSC conducts an annual survey to track vessel owners and operators. The *Waterborne Transportation Lines of the United States for Calendar Year 2000*, updated through October 2021, identified 12 vessel companies and their American flagged vessels transporting freight and passengers on Cape Cod Bay and/or Cape Cod Canal.<sup>22</sup>

### 6.1.6 Airports

Four airports are located within approximately 30 miles of the Program Study Areas: New Bedford Regional Airport, in New Bedford; Cape Cod Gateway Airport, in Barnstable; Otis Air National Guard Base Airport, on JBCC; and Martha's Vineyard Airport, in West Tisbury. None of these airports are located within the Bourne or Sagamore Program Study Areas.

### 6.1.7 Transit and Parking Facilities

The Cape Cod Regional Transit Authority's (CCRTA's) year-round fixed public transit service operating in and near the Bourne and Sagamore Program Study Areas consists of the Bourne Run and the Sandwich Line. The Bourne Run travels between Buzzards Bay Train Station and Mashpee Commons, crossing both Bourne and Sagamore highway bridges, with stops at Cape Side Convenience (105 Trowbridge Road), the Bourne Recreation Area, and One Trowbridge Place. The Sandwich Line travels between downtown Hyannis to Buzzards Bay through the town of Sandwich, with stops at Bourne Scenic Park, Sagamore Park and Ride (1 Canal Road), Market Basket (1 Factory Outlet Road), and Canal View Apartments (Sandwich Road). Peter Pan Bus Lines, a private bus carrier, also operates in the Town of Bourne with stops at Cape Side Convenience and Sagamore Park and Ride Lot.

---

<sup>21</sup> U.S. Army Corps of Engineers, Institute for Water Resources. <https://ndc.ops.usace.army.mil/wcsc/webpub/#/report-landing/year/2019/region/1/location/171>. Calendar Year 2019 is the most recent pre-Covid year with a 5-year Cargo Report and 5-year Trips Report.

<sup>22</sup> U.S. Army Corps of Engineers, Institute for Water Resources. *Waterborne Transportation Lines of the United States*, Calendar Year 2000, Volumes 1 through 3 consolidated. Published October 2021. Ferries are included in the listing; floating equipment used in construction work, fishing vessels, and recreational craft are not included in the listing.

The CCRTA operates the CapeFLYER, which provides summer weekend service to Cape Cod through the Middleborough/ Lakeville commuter rail line. The service runs from South Station in Boston to the Hyannis Transportation Center, with a stop at the Bourne Station located on Main Street. Bourne Station consists of a high-level platform that can accommodate a single coach stopped at the platform.

Commuter parking facilities in the Program Study Area include MassDOT’s Sagamore (Bourne) Park and Ride Lot, northeast of the Sagamore Bridge on 2 Canal Street, with 377 parking spaces.

## 6.2 Preliminary Impacts Assessment

Section 6.2 presents potential impacts to transportation facilities within the Program Study Areas associated with the Program. Preliminary permanent impacts include impacts due to the Program’s bridge replacement structures (including profile and cross section), fully offline inboard mainline alignment location, center span length, paired with the interchange approach alternatives. Section 2.1 shows schematics of the preferred mainline alignment location (Figures 2-3 and 2-4) and center span length (Figure 2-6). The ten interchange approach alternatives are presented in Section 2.1.5 and summarized in Table 2-1. Figures 2-7 through 2-16 in Section 2.1 present schematics of the preferred interchange approach alternatives.

### 6.2.1 Transportation Facility Impacts

Tables 6-1 and 6-2 present potential transportation facility impacts in the Bourne and Sagamore Program Study Areas.

**Table 6-1. Bourne Program Study Area – Estimated Transportation Facility Impacts**

Transportation Facility Impacts (rounded)	Bourne Crossing Interchange Approach Alternatives				
	Bourne North Crossing			Bourne South Crossing	
	Northbound On-Ramp	Single Exit Partial Interchange	Northbound On-Ramp	Single Exit Partial Interchange	Northbound On-Ramp
Alteration of bank or terrain located ten or more feet from existing roadway for one-half or more miles (linear feet)	28,600	27,300	29,900	21,800	21,600
Cutting of living public shade trees of 14+ inches in diameter at breast height (Number)	5	6	9	0	0
Elimination of stone wall (linear feet)	0	0	0	126	325



**Table 6-2. Sagamore Program Study Area - Estimated Transportation Facility Impacts**

Transportation Facility Impacts (rounded)	Sagamore Crossing Interchange Approach Alternatives				
	Sagamore North Crossing		Sagamore South Crossing		
	Similar to Existing Configuration	Direct Connection to State Road	Similar to Existing Configuration	Direct Connection to State Road	Similar to Existing Configuration
Alteration of bank or terrain located ten or more feet from existing roadway for one-half or more miles (linear feet)	18,800	17,800	25,200	20,500	25,300
Cutting of living public shade trees of 14+ inches in diameter at breast height (Number)	0	0	0	0	0
Elimination of stone wall (linear feet)	0	0	0	0	0

### 6.2.2 Cape Cod Canal Navigation

The operation of the replacement bridges’ preferred option, a tied-arch bridge on a Delta frame configuration with an approximate 700-foot mainline span length, would not impact navigation. With the location of the bridge piers along the waterline or on land adjacent to the canal, the replacement bridges would improve existing navigation conditions by effectively increasing the horizontal width available for vessel passage.

Demolition and construction activities would temporarily impact navigation. Throughout the construction period, certain activities would require a partial restriction or full closure of the navigation channel.

Activities requiring partial restrictions include the use of a cofferdam for bridge pier construction. Additionally, there would be temporary encroachment into the navigation channel from installation of the pier foundations and the use and positioning of construction equipment in the canal, including equipment, material, and support barges. It is anticipated that for each crossing, demolition of the

existing bridge would require a short-term full channel closure for removal of the center span and horizontal restrictions for removal of the remaining superstructure and substructure elements, and installation of the replacement bridge would require a single, short-term full channel closure.

To the greatest extent practicable, MassDOT would coordinate construction and demolition activities to ensure that activities are taking place in one half of the navigation channel at a time, allowing vessel traffic to travel through the construction area in the open half of the channel.

MassDOT would coordinate construction and demolition activities with the USACE Marine Operations Section. It is anticipated that through the construction period, the Marine Operations Section would monitor vessel traffic for potential impacts, provide marine traffic control and enforce restrictions as needed, and support construction site safety.

Temporary aids to navigation, including navigation lighting, notices to mariners, channel closure signs, stop/slow signs, advance warning signs and lateral guidance, would be used in coordination with the USCG to assist vessels during construction.

### **6.2.3 Airports**

In accordance with 29 USC 44718 and 14 CFR 77, during final design, MassDOT will submit a Notice of Construction and request for review by the Federal Aviation Administration (FAA) to confirm that the replacement bridge structures would not exceed FAA obstruction standards and would not present a hazard to air navigation.

### **6.2.4 Transit and Parking Facilities**

Based on MassDOT's proposed fully offline inboard mainline alignment location for each bridge crossing, impacts to existing transit and parking facilities are not anticipated. As design advances, MassDOT will conduct further evaluation of potential impacts associated with the preferred interchange approach alternative for each crossing. The DEIR will present the results of the impacts evaluation and will identify mitigation measures as needed.

## **6.3 Next Steps**

Concurrent with the development of the preferred interchange approach alternative for each crossing, MassDOT will refine the proposed bicycle and pedestrian connections to the local roadway network and existing bicycle/pedestrian shared used paths, including assessing impacts and identifying mitigation as required.

As design advances, MassDOT will refine impacts to roadways and other transportation facilities associated with the Bourne and Sagamore crossing interchange approach alternatives, including operational and construction impacts. MassDOT will identify mitigation measures to address roadway and transportation facility impacts of the Cape Cod Bridges Program in the DEIR.

## 6.4 Induced Visitor Travel Demand

Based on input received during the MassDOT public information meetings held in fall 2022 through spring 2023, MassDOT noted concerns from local residents that the proposed improvements to highway safety design and traffic operations would encourage additional visitor vehicle travel across the bridges, thus failing to improve traffic congestion. To address these concerns, MassDOT examined the potential for induced visitor travel demand due to proposed Program improvements.

Cape Cod's popularity as a vacation destination creates a strong demand for vehicle access across the Sagamore and Bourne Bridges during summer weekends. The bridges, adjacent highway interchange connections, and other surrounding roadways experience traffic congestion in both peak and non-peak hours each summer as visitors travel to Cape Cod.

The Program is needed to address the substandard design of the bridges and their approach roadway networks, which contribute to poor traffic operations and high crash rates within vicinity of Cape Cod Canal. To comply with current MassDOT and FHWA design and safety standards, the replacement of the existing bridges would include providing travel lanes wider than the existing lanes, an auxiliary lane to provide a safer interface with the adjacent access ramps on each side of the bridges, and shoulders to provide refuge for vehicles in emergency situations, access for first responders, and an additional recovery area for drivers trying to avoid conflicts in the adjoining travel lanes.

Induced travel demand could occur from new trips due to latent demand or from modifications of existing travel patterns. Trips due to latent demand are identified as new trips that drivers would make if travel conditions improved, such as less congestion or higher design speeds. MassDOT assessed the potential for latent visitor demand trips within the context of typical seasonal vacation trips. In general, seasonal trips to Cape Cod are long distance in nature, where visitors travel from mainland Massachusetts, New England, and beyond, and involve stays of multiple days. Compared to the overall trip length, the travel time savings from any operational improvements to the bridges would represent only a minor benefit to the overall trip and represent an even smaller portion of the whole trip. As such, it is not anticipated that the safety and operational improvements of the Program would encourage additional visitor vehicle trips.

In addition to trips due to latent demand, induced travel demand could result from changing travel patterns. The following describes three common causes of induced travel demand that are not due to new travel, but to modifications of existing trip activities. MassDOT examined whether these modifications could apply to the Bourne and/or Sagamore replacement bridges.

1) *Route redistribution, where a driver travels across the replacement bridge as a new route instead of using a previous non-bridge-related route.* The bridges provide the only vehicular access across Cape Cod Canal; therefore, it is impossible for there to be induced travel demand resulting from route redistribution.

2) *Modal shifts from one form of transportation to another, where a transit rider shifts to driving a private vehicle to travel across the bridge.* While on- and off-Cape public and private transit and rail service exists, it is limited. While there is an opportunity for people traveling by other modes to be diverted to personal vehicles, these numbers would represent a small percentage of overall vehicular travel over the bridges.

3) *Shifts from off-peak hour travel to peak hour travel, where a driver deliberately travels on the bridges during off-peak hours to avoid congestion and then returns to peak-hour travel after the bridge replacement.* This example of induced travel demand could happen after completion of the replacement bridges. Based on traffic modeling conducted for the 2045 No-Build and Build conditions, approximately 25 percent of the summer Saturday peak period trip demand could shift to off-peak hours due to added congestion caused by expected visitor growth. This trip demand could then switch back to peak hour travel after the bridge completion and improved travel conditions.<sup>23</sup> No travel shift between peak and off-peak hours is expected during the fall weekday afternoon (PM) peak period. Based on modeling for the Build condition, the travel shifts back to the peak period traffic would be likely to occur during the peak summer months, and would occur mostly during the Saturday peak and, to a lesser extent, during summer weekday PM peak periods.

## 6.5 Consistency with Plans and Policies

The Cape Cod Bridges Program is consistent with state and regional plans and policies related to traffic and pedestrian and bicycle transportation facilities and services, including the Massachusetts Bicycle Plan, the Massachusetts Pedestrian Plan, and the Cape Cod Regional Transportation Plan. Sections 3.2.1.2 and 3.2.2.2 discuss the Program's consistency with the Bourne and Sandwich local comprehensive plans.

While it is cited as a regionally significant future project, replacement of the Cape Cod Canal bridges and their approach networks is not included in the Cape Cod 2023-2027 Transportation Improvement Program (TIP).

### 6.5.1 Massachusetts Bicycle Transportation Plan

By providing a separated pedestrian/bicycle shared use path for each replacement bridge, the Program would incorporate a key initiative to build connected, safe, and comfortable bicycle networks and corresponding actions of the 2019 *Massachusetts Bicycle Transportation Plan*:

- Complete high-comfort bikeway projects on MassDOT-owned roadways to help improve bike and trail connectivity;
- Preserve and ensure adequate right-of-way for high comfort bike networks when selling, leasing, transferring, or providing an easement on MassDOT property;

---

<sup>23</sup> An example of this travel shift would be a weekend Cape Cod visitor who schedules their off-Cape return trip to occur on Saturday night, to avoid Sunday afternoon travel across the bridges and accompanying congestion. Once construction of the replacement bridges is complete, the visitor then returns to Sunday afternoon travel across the bridges.

- Incorporate bike access in transportation projects within a 10-minute bike ride (1.7 miles) to a transit stop or station throughout the project development process.

Additionally, the Program would extend bicycle connectivity to the local roadway networks and the Cape Cod Canal bike path.

### **6.5.2 Massachusetts Pedestrian Transportation Plan**

The inclusion of a separated pedestrian/bicycle shared use path for each replacement bridge, and extension of the pedestrian/bicycle network to the roadway approach networks would incorporate a key initiative of the 2019 *Massachusetts Pedestrian Transportation Plan* to complete prioritized pedestrian-specific projects on MassDOT-owned roadways and bridges that address safety, critical gaps in connectivity, and accessibility.

### **6.5.3 Cape Cod 2020 Regional Transportation Plan**

The Program is consistent with the Cape Cod Metropolitan Planning Commission's *Cape Cod 2020 Regional Transportation Plan, 2020-2040* (endorsed July 15, 2019). Below is a list of applicable objectives from the Regional Transportation Plan, followed by a statement of how the Program would address them:

- *To minimize the negative impacts of the transportation system on the natural environment.* The Program would incorporate best management practices (BMPs), including stormwater management techniques, to minimize impacts to natural resources.
- *To improve the transportation system's resiliency to the effects of sea level rise.* The vertical clearance of the replacement bridges would be increased to address sea level rise.
- *To develop a transportation system that is consistent with the local character of Cape Cod.* The design of the replacement bridges would minimize adverse visual impacts to the NRHP-eligible Cape Cod Canal District.
- *To expand the sidewalk and bicycle network and close gaps in these networks.* Each bridge crossing would include a pedestrian/bicycle shared use path that will extend to and connect with the local roadway network.
- *To minimize the impacts of construction delays on all users, particularly impacts of Cape Cod Canal Bridge maintenance.* For the duration of the Cape Cod Bridges Program construction, MassDOT proposes to maintain existing traffic patterns and reduce construction impacts to the greatest extent possible.
- *To improve the condition of all state and municipally owned bridges.* The Program's preliminary purpose and need is to address the functional obsolescence of the existing highway bridges. Further, MassDOT proposes to incorporate a resilient structure that will accommodate sea level rise.
- *To minimize Cape Cod Canal bridge maintenance impacts.* MassDOT proposes to replace the aging Bourne and Sagamore bridges with new bridges designed and built to modern highway and bridge standards. The new bridges would reduce long-term maintenance requirements and minimize disruptions to traffic flow across the Cape Cod Canal.

## 7 Historic and Archaeological Resources Section

This section presents inventoried historic resources in the Program Study Areas and describes the process for evaluating and addressing potential impacts of the Program upon historic and archaeological resources in compliance with Section 106 of the National Historic Preservation Act.

### 7.1 Existing Conditions

#### 7.1.1 Inventoried Historic Resources

The Bourne and Sagamore Program Study Areas include buildings, structures, sites, landscapes, and objects listed in the Massachusetts Cultural Resource Inventory System (MACRIS) database. Table 7-1 identifies inventoried historic resources included in the MACRIS database within and near the Program Study Areas, as documented in the *Cultural Resources Identification and Evaluation Report* prepared by MassDOT's Cape Cod Canal Transportation Study.<sup>24</sup> Properties listed in the National Register of Historic Places (NRHP) are automatically listed in the Massachusetts State Register of Historic Places (SRHP).

**Table 7-1. Historic Resources in the Bourne and Sagamore Program Study Areas**

MHC ID #	Resource	NRHP & SRHP Status/ MACRIS Inventoried	Inventoried Resources
BOU.919	Bourne Bridge	NRHP-Eligible	Contributing to BOU.AF
BOU.918	Sagamore Bridge	NRHP-Eligible	Contributing to BOU.AF
BOU.AF/FAL.BG/ SWD.Z/WRH.V	Cape Cod Canal Historic District	NRHP-Eligible District; SRHP-Listed	18 contributing resources
BOU.A	Keene Street - Sandwich Road Area	NRHP-Eligible District	28 contributing resources, including NRHP-Listed properties
BOU.AE/BOU.68	Bourne Town Hall Historic District	NRHP and SRHP-Listed District	Multiple listed resources
BOU.AG	Aptucxet Trading Post Museum Historic District	NRHP and SRHP-Listed District	Multiple listed resources
BOU.AH	Shore Road North Area	Inventoried	>12 inventoried resources
BOU.AJ	County Road North Area	Inventoried	>36 inventoried resources
BOU.B	Cape Cod Air Station - Otis Air Force Base (Camp Edwards)	Inventoried	Several inventoried resources
BOU.I	Bournedale Area	Inventoried	16 inventoried resources, including NRHP-Listed & Eligible properties
BOU.J	Main Street Commercial Area	Inventoried	20 inventoried resources
BOU.O	North Sagamore Area	Inventoried	13 inventoried resources
BOU.P	Savery Avenue Area	Inventoried	15 inventoried resources

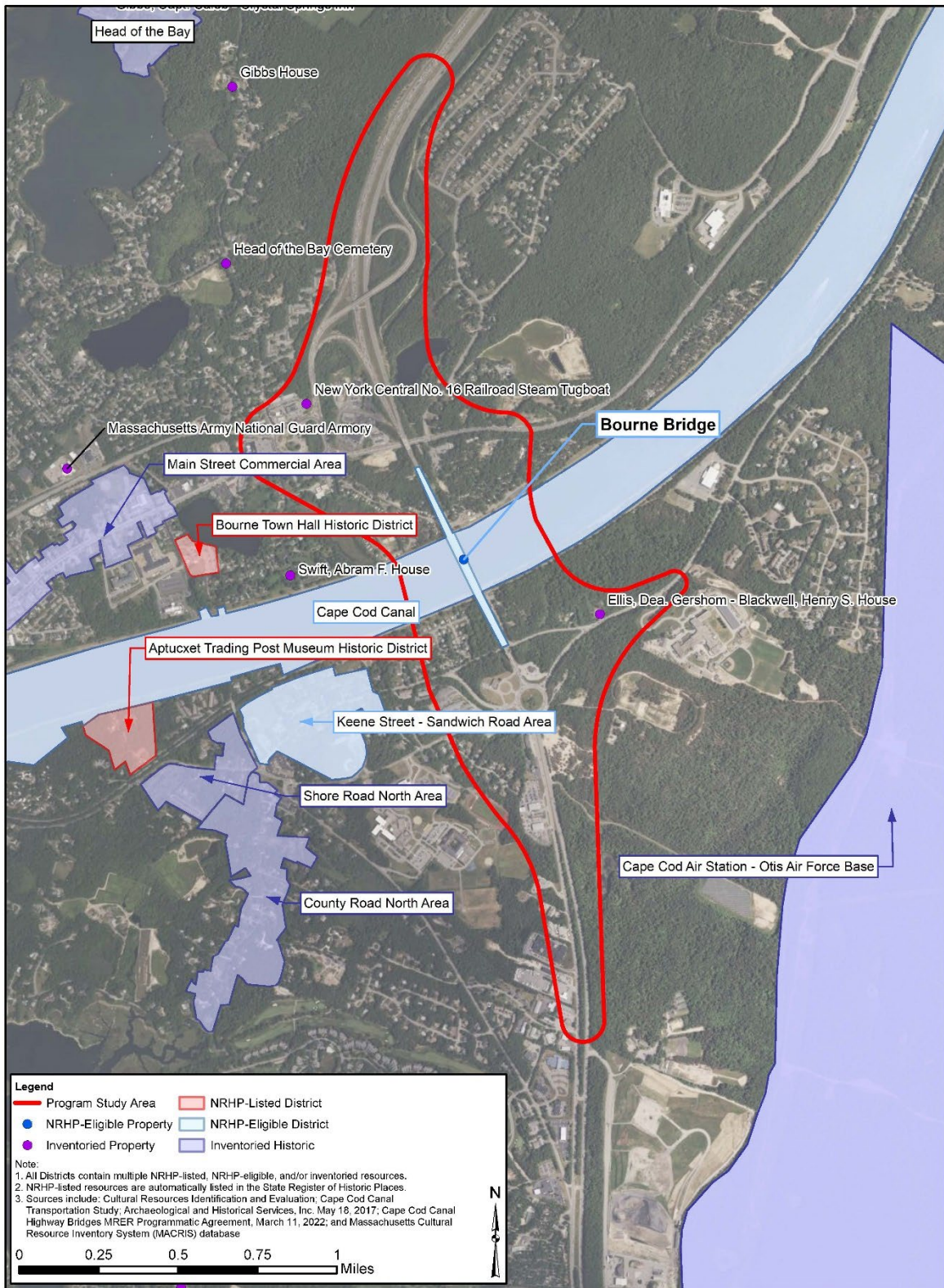
<sup>24</sup> Archaeological and Historical Services, Inc. *Cultural Resources Identification and Evaluation, Cape Cod Transportation Study*. Prepared for Stantec, for submission to the Massachusetts Department of Transportation, May 18, 2017.

MHC ID #	Resource	NRHP & SRHP Status/ MACRIS Inventoried	Inventoried Resources
BOU.U	Sagamore Beach Area	Inventoried	13 inventoried resources
BOU.V	South Sagamore Area	Inventoried/NRHP- Potentially Eligible District	41 inventoried resources
BOU.803	Head of the Bay Cemetery	Inventoried	--

Cape Cod Canal was originally constructed by the Boston, Cape Cod, and New York Canal Company under a Charter issued by the Commonwealth of Massachusetts to provide coastwise shipping with a more direct and safer route from northern New England ports to other areas on the eastern seaboard. The Charter required the Canal Company to build and operate two highway bridges and a railroad bridge over the canal, which were built as low-level draw spans. Construction began in 1909 and the canal was opened to marine traffic in 1914. The Federal government took control of the canal during World War I and operated the canal through the 1920s. The canal was acquired by the Federal government in 1928. Under the authority of the National Industrial Recovery Act of June 1933, the Public Works Administration authorized the construction of three bridges over the canal, two highway and one railroad, in keeping with the terms of the original Massachusetts Charter. The Bourne and Sagamore highway bridges were completed and open to traffic in 1935.

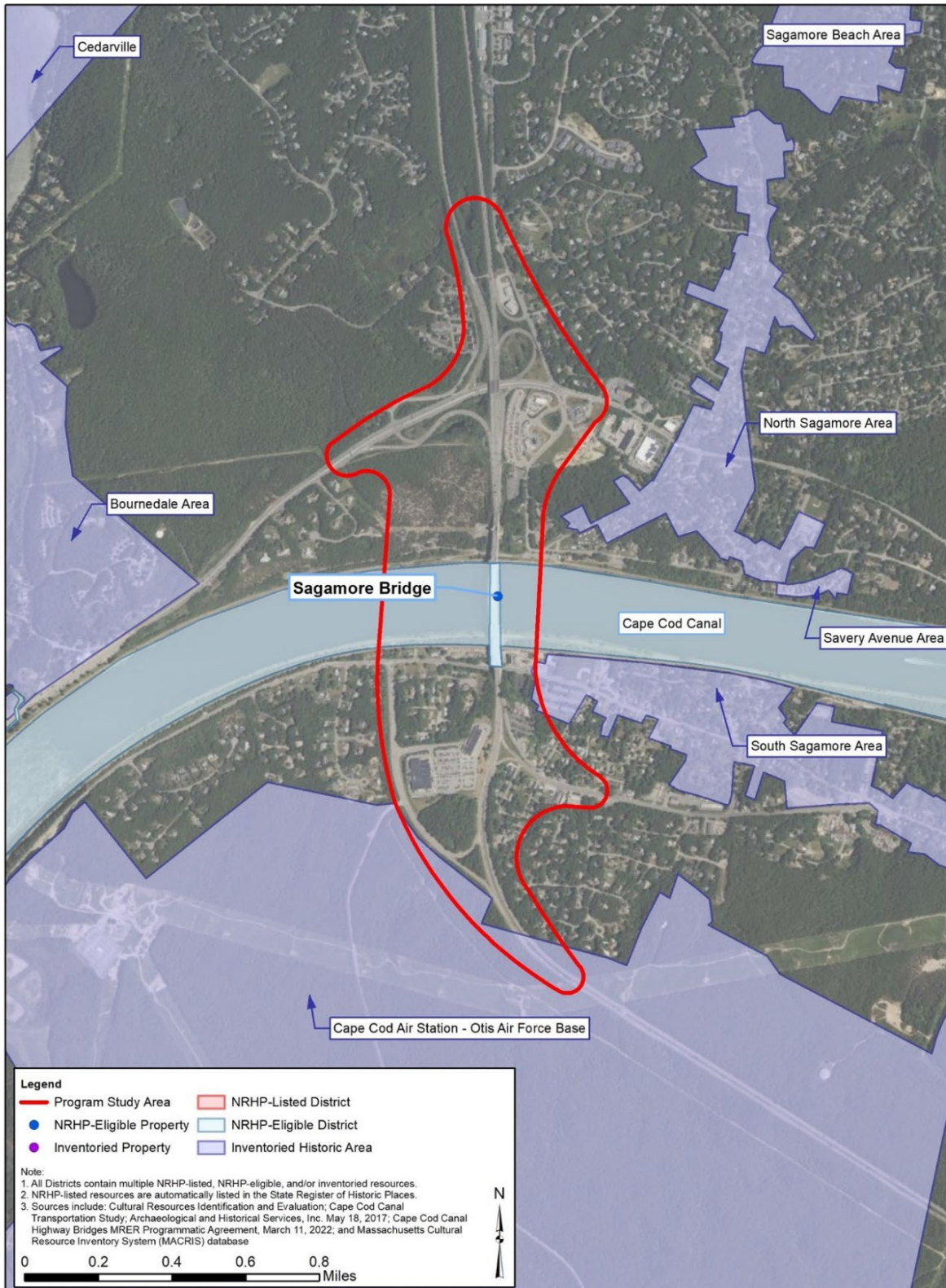
Per the Massachusetts Historical Commission (MHC), the State Historic Preservation Officer (SHPO), the Cape Cod Canal area (BOU.AF/FAL.BG/ SWD.Z/WRH.V) meets the criteria of eligibility for listing in the NRHP as an historic district. It consists of 23 historic resources, 18 of which would be contributing resources. These resources include Bourne Bridge (BOU.919) and Sagamore Bridge (BOU.918), which were formally recommended by MHC in 1991 to be eligible for individual listing in the NRHP and determined to be contributing elements to the Cape Cod Canal Historic District.

In addition to the Cape Cod Canal and historic bridges within the Program Study Areas, multiple historic districts and individual resources are close to the two study area boundaries. Figure 7-1 shows historic properties and areas and their status within and near the Bourne Program Study Area. Figure 7-2 shows historic areas and their status near the Sagamore Program Study Area.



**Figure 7-1. Historic Properties in and near the Bourne Program Study Area**





**Figure 7-2. Historic Properties in and near the Sagamore Program Study Area**

### **7.1.2 Archaeological Resources**

Multiple archaeological resources have been documented in and near the Program Study Areas, including pre-colonial sites and historic-period archaeological sites. The USACE's MRER/EA indicated that there are no recorded archaeological sites within the vicinity of Sagamore Bridge; there are two recorded archaeological sites within the vicinity of Bourne Bridge. Native American Tribes consider the Program Study Area to be culturally and archaeologically sensitive.

## **7.2 Preliminary Impacts Assessment**

The Preferred Alternative, In-Kind Bridge Replacement updated to comply with federal and state highway and design safety standards, would require demolition of Bourne and Sagamore highway bridges. As NRHP-eligible resources, their demolition would cause an adverse effect to those two NRHP-eligible structures in accordance with Section 106 of the NHPA. The removal and replacement of the existing bridges and the creation and use of temporary construction staging, and access areas could result in an adverse effect to the NRHP-potentially eligible Cape Cod Canal Historic District. Additionally, Program actions that would create temporary or permanent impacts to the areas around the bridges and Program Study Areas could affect archaeological resources.

As required by Section 106 of NHPA, MassDOT will establish an Area of Potential Effects (APE) for each bridge crossing, including the replacement bridge and the interchange approach network for each crossing. The APE is defined as the geographic area within which the Program may directly or indirectly cause alterations in the character or use of historic properties.

A professional archaeological firm will prepare an archaeological reconnaissance report for MassDOT to determine areas of archaeological sensitivity within the APE. MassDOT will then conduct a professional archaeological survey based on the Reconnaissance Report, as design options are developed and refined. Any necessary archaeological surveys on federal land shall be conducted under a permit issued in accordance with the U. S. Archaeological Resource Protection Act. Any necessary archaeological survey on non-federal land shall be conducted under a permit issued by the State Archaeologist. MassDOT will consult with the Tribes throughout Program design, including archaeological investigations, and will invite the Tribes to participate in all archaeological field investigations.

## **7.3 Section 106 Consultation**

### **7.3.1 Early Consultation**

During the preparation of the MRER/EA for the Cape Cod Canal Highway Bridges Project, the USACE initiated cultural resources coordination with the Massachusetts State Historic Preservation Officer (SHPO), the Massachusetts Board of Underwater Archaeological Resources (BUAR), the Tribal Historic Preservation Officers (THPOs) of the Mashpee Wampanoag and the Wampanoag Tribe of Gay Head (Aquinnah), the Cape Cod Commission, and the Historical Commissions of the Towns of Bourne and Sandwich. The SHPO and both THPOs participated in the agency scoping meeting and site visit for the MRER/EA on March 19, 2019. Cultural resources coordination letters were sent to the SHPO and Tribes on July 17, 2019. On August 22, 2019, the SHPO concurred with the USACE's determination that the replacement of the Bourne and Sagamore Bridges would have an adverse effect on the two NRHP-

eligible bridges and at least two identified archaeological sites, possible unidentified archaeological resources, and several historic districts. Adverse effects include indirect, visual or viewshed effects, and potential direct (archaeological) effects. Attachment 7.1 includes documentation of previous consultation.

On March 11, 2022, a Programmatic Agreement (PA) was finalized between USACE and MHC as signatories on the Cape Cod Canal Highway Bridges Project (Attachment 7.2). MassDOT was an invited signatory and the BUAR, the Cape Cod Commission, and the Historical Commissions of the Towns of Bourne and Sandwich were concurring parties. The THPOs of the Mashpee Wampanoag and the Wampanoag Tribe of Gay Head (Aquinnah) were invited concurring parties. The PA includes several important determinations, including:

- USACE determination and SHPO concurrence that the Cape Cod Canal area is eligible for listing in the NRHP as an historic district;
- USACE concurrence with SHPO recommendations that the Bourne and Sagamore Bridges meet the criteria for individual listing in the NRHP as well as contributing elements of the Cape Cod Canal historic district;
- USACE determination and SHPO concurrence that the demolition of the Bourne and Sagamore Bridges will have an adverse effect on those two NRHP-eligible structures.

The PA establishes the process for addressing effects to above-ground and below-ground resources to be implemented by USACE in coordination with MassDOT. To address above-ground resources, the PA establishes a process for refining the Area of Potential Effect (APE), conducting viewshed analysis, incorporating a bridge design to avoid adverse effects to the NRHP-eligible Cape Cod Canal Historic District and NRHP-eligible properties within the viewshed of the undertaking, and identifying mitigation measures to resolve adverse effects. Additionally, the PA establishes a process for conducting professional archaeological surveys under appropriate permits on federal and non-federal land, in consultation with the Tribes and SHPO. Attachments to the PA include USACE's procedures for post-review discoveries and MassDOT's special provisions for the discovery of unanticipated archaeological and skeletal remains. The Cape Cod Bridges Program currently is operating under the March 2022 PA.

### **7.3.2 Programmatic Agreement and Memorandum of Agreement**

It is anticipated that an amended PA<sup>25</sup> and a new Memorandum of Agreement (MOA) among FHWA, SHPO, USACE, and MassDOT will be prepared for the Cape Cod Bridges Program. The new PA and MOA will address direct and indirect adverse effects to the historic resources. Indirect effects, consisting of visual or viewshed effects, include those from within the NRHP-eligible Cape Cod Canal Historic District and those from NRHP-eligible historic districts and historic buildings located outside the boundaries of the Cape Cod Canal Historic District. It is anticipated that FHWA, SHPO, USACE, and MassDOT will serve as signatories to the PA and MOA. Local stakeholders, including the Bourne and Sandwich Historical Commissions, and THPOs will serve as concurring parties to the PA and MOA.

---

<sup>25</sup> It is anticipated that the existing PA will be amended to include FHWA as a signatory.

Adverse effects to above-ground resources will be mitigated through measures (stipulations) identified and agreed upon during ongoing agency and stakeholder coordination. Mitigation measures could include activities related to evaluating and documenting historic and archaeological resources in the Program Study Areas, preserving salvageable items from the Bourne and Sagamore Bridges, and consulting with the SHPO to develop designs for the replacement bridges that are visually compatible with the Cape Cod Canal Historic District.

The PA will include an Archaeological Treatment Plan to address Program impacts to archaeological resources. Mitigation measures for archaeological resources will be refined once the types and significance of archaeological resources in the APE are known and Program impacts are defined.

#### 7.4 Next Steps

MassDOT will continue cultural resources consultation with SHPO, the BUAR, stakeholders, and Native American Tribes through design completion of the Cape Cod Bridges Program. In addition to the THPOs of the Mashpee Wampanoag and the Wampanoag Tribe of Gay Head (Aquinnah), FHWA and MassDOT will expand Tribal consultation to include the THPO of the Herring Pond Wampanoag Tribe as a consulting party (Attachment 7.3).

The DEIR will identify the APE to be developed for each bridge crossing and will provide MassDOT's evaluation of potential impacts of the construction and operation of Cape Cod Bridges Program on the APE's historic resources. In accordance with the PA, the DEIR will present the process for identifying and evaluating archaeological resources, including identifying avoidance, minimization, and/or mitigation measures.

It is anticipated that the DEIR will include an amended PA that will supersede the existing March 2022 PA. MassDOT anticipates that the Program MOA will be prepared based on advanced design and refined Program impacts.

#### 7.5 Consistency with Preservation Plans and Policies

The Cape Cod Bridges Program is consistent with state, regional, and local plans and policies related to preserving historical and archaeological resources.

The Program is consistent with the goals and objectives of the Massachusetts State Historic Preservation Plan, 2018-2022 (July 26, 2018) related to identifying and documenting historic and archaeological resources, evaluating, and registering historic resources, and protecting historic resources through education. The Program PA will establish the process for investigating, documenting, and protecting historic resources in the Program Study Areas.

The Program is consistent with the Cape Cod Commission's Regional Policy Plan's community design and cultural heritage goals and the historical and cultural heritage goals of the towns of Bourne and Sandwich. The Regional Policy Plan's community design goal to "protect and enhance the unique

character of the region’s built and natural environment based on the local context” includes the objectives of promoting context-sensitive site design and avoiding adverse visual impacts from infrastructure to scenic resources. The Plan’s cultural heritage goal to “protect and preserve the significant cultural, historic, and archaeological values and resources of Cape Cod” includes the objectives of protecting and preserving forms, layouts, scale, massing, and key character defining features of historic resources; and protecting and preserving archaeological resources and assets from alteration or relocation. The Bourne LCP’s cultural heritage goal includes ensuring that future development respects the traditions and distinctive character of Bourne’s historic village centers. Similarly, the Sandwich LCP sites the need to protect the historic character of the town.

MassDOT will consult with MHC, Section 106 consulting parties, and the community to develop a context-sensitive design of the replacement bridges that is compatible with the NRHP-potentially eligible Cape Cod Canal District and other surrounding historic resources. Additionally, the Program PA will include an Archaeological Treatment Plan for the protection and preservation of archaeological resources identified during cultural resource investigations.

## 8 Climate Change Adaptation and Resiliency Section

This section discusses potential climate change risks that could impact the Program and identifies measures that MassDOT will incorporate to build a climate resilience Program.

### 8.1 Measures to Adapt to Climate Change

In accordance with the MEPA Interim Protocol on Climate Change Adaptation and Resiliency (effective October 1, 2021), the Cape Cod Bridges Program Study Areas and design parameters were input to the “Resilient Massachusetts Action Team” (RMAT) Climate Resilience Design Standards Tool (the RMAT Tool) to identify exposures to climate change risks. The RMAT Tool provides preliminary guidance for state-funded projects to enhance how the Commonwealth of Massachusetts assesses climate resilience as part of its capital planning process through climate change exposure and risk ratings of assets and adaptation best practices.

Based on the Program input parameters, the RMAT Tool Project Reports (provided in Attachment 8) identified “High Risk Exposures” for the Program Study area relative to sea level rise/coastal storm surge, extreme heat, and urban/riverine flooding. The following sub-sections address how the Program will incorporate climate resilience measures for each source of climate exposure identified, resulting in an overall improvement over existing condition.

#### 8.1.1 Sea Level Rise

MassDOT conducted an analysis of best available data to inform the investigation of the proposed replacement bridges’ vulnerability to future risk of sea level rise (SLR) with respect to navigational operational clearance. Table 8-1 lists the climate data sources that were reviewed to inform SLR projections from which to base future Program planning. The analysis was conducted under the assumption that the Bourne and Sagamore bridges would be replaced over a construction duration of

seven years, starting in 2028, with an anticipated completion date of 2035. The bridge useful life is 100-years, extending to the year 2135. The construction start and stop dates identified in this analysis are estimates only and will be revisited as the Program schedule is finalized.

As a best practice, the modeling uncertainty associated with global emissions scenarios and related SLR projections must be considered when planning and designing-for long-lived critical infrastructure. Therefore, SLR projections extending beyond end of century were not considered as part of this analysis.

**Table 8-1. List of Reviewed Climate Data Sources**

Resource/Publication Date	Publication Date	Scale of Analysis - Global Mean Sea Level Rise (GMSL) vs. Downscaled/Relative Sea Level Rise (RSL) <sup>26</sup>
<b>Intergovernmental Panel on Climate Change - Sixth assessment Report (IPCC, AR6)</b>	2022	GMSL
<b>National Oceanic and Atmospheric Administration, Global and Regional Sea Level Rise Scenarios for the United States (NOAA)/Fifth US National Climate Assessment (NCA5 - Forthcoming)</b>	2022	RSL: Local projections for Buzzards Bay Tidal Station and Sandwich Marina Tidal Station following USACE Sea Level Rise Calculator Methodology <sup>27</sup>
<b>Cape Cod Canal Highway Bridges - Bourne, Massachusetts: Major Rehabilitation Evaluation Report and Environmental Assessment, US Army Corps of Engineers (USACE-MRER)</b>	2020	RSL: Local projections for Woods Hole Tidal Station following USACE Sea Level Rise Calculator Methodology <sup>28</sup>
<b>Massachusetts Climate Change Projections (MCCP), MA Executive Office of Energy and Environmental Affairs</b>	2018	Downscaled/RSL: Downscaled projections for Woods Hole Tidal Station
<b>Greater Boston Research Advisory Group (GBRAG)</b>	2022	Downscaled/RSL: Downscaled projections for Boston Harbor

A review of downscaled and relative SLR projections relative to bridge superstructure elevations indicates that the bridge superstructures will remain well outside anticipated future mean high water (MHW) elevations through their design life. Therefore, maintaining the necessary 135-foot vertical

<sup>27</sup> USACE. 2014. Procedures to Evaluate Sea Level Change: Impacts, Responses, and Adaptation. Technical Letter 1100-2-1. U.S. Army Corps of Engineers, Washington, DC, 254 pp. [https://www.publications.usace.army.mil/portals/76/publications/engineertechnicalletters/etl\\_1100-2-1.pdf](https://www.publications.usace.army.mil/portals/76/publications/engineertechnicalletters/etl_1100-2-1.pdf)

<sup>28</sup> USACE. 2014. Procedures to Evaluate Sea Level Change: Impacts, Responses, and Adaptation. Technical Letter 1100-2-1. U.S. Army Corps of Engineers, Washington, DC, 254 pp. [https://www.publications.usace.army.mil/portals/76/publications/engineertechnicalletters/etl\\_1100-2-1.pdf](https://www.publications.usace.army.mil/portals/76/publications/engineertechnicalletters/etl_1100-2-1.pdf)

clearance to accommodate ship traffic (i.e., navigational operational clearance) through Cape Cod Canal is the primary factor for establishing a SLR value for design consideration. Based on preliminary analysis, it is anticipated that the vertical clearance of the replacement highway bridges would be designed to accommodate approximately 3.18 feet of SLR. Following a “High Scenario,” relative SLR data provided by NOAA indicate SLR projections of 3.15 feet and 3.18<sup>29</sup> feet at the Buzzards Bay Tidal Station and Sandwich Marina Tidal Station, respectively, for the year 2070.<sup>30</sup>

### **8.1.2 Coastal Storm Surge**

RMAT identifies coastal storm surge as a High Exposure source of risk for the Program Study Area. In accordance with guidance provided by RMAT where “additional site analyses are recommended to establish design values associated with design criteria,” MassDOT is developing a Program specific, locally based, hydraulic model to inform bridge pier design. This model input will include return period projections derived from best available SLR data provided by Massachusetts Climate Change Projections.

MassDOT would design the bridge piers to account for periodic coastal stormwater inundation, which is a standard practice for bridge design. Application of this Program-specific hydraulic model would inform the necessary site design BMPs and mitigation measures to protect the bridge substructures from storm surge inundation impacts such as scour. The bridge piers would be designed to withstand scour for the 0.5 percent annual exceedance probability storm event in accordance with FHWA requirements and adjusted for SLR. Adaptations examples include deep foundations, rip-rap hardening, and nature-based solutions intended to dissipate wave action and reduce erosion/scour. This hydraulic model would be used to inform related Program elements, such as the design of the interchange approach network and stormwater management. Application of this project-specific hydraulic model also would inform the necessary site design BMPs and mitigation measures to address adverse impacts from urban flooding upon adjacent properties to the maximum extent practicable. Adaptation measures would focus on nature-based solutions.

### **8.1.3 Extreme Heat**

RMAT identifies extreme heat as a High Exposure source of risk for the Program Study Area. This high-risk exposure score is derived from an increase in impervious area, removal of trees as part of the proposed Program, projected increases in extreme heat days over the design life of the Program elements, and the location of the bridges within 100 feet of an existing water body. The bridge materials are not sensitive to extreme heat in the climate range. Regarding temperature related expansion and contraction, the MassDOT Bridge Manual requires bridges to be designed for a temperature range of between -30 degrees Fahrenheit and +120 degrees Fahrenheit. According to the Massachusetts Climate Change Projections<sup>31</sup> developed for MA EEA, temperature extremes greater than 120 degrees Fahrenheit are not projected

---

<sup>29</sup> Relative to baseline year 2000. According to NOAA, local scenarios have been adjusted to 2000 to compare them more easily with the 2017 RSL scenarios. They take into account global mean sea level rise (GMSL), regional changes in ocean circulation, changes in Earth’s gravity field due to ice melt redistribution, and local vertical land motion.

[NOAA Sea Level Rise Viewer](#) – Local Scenarios for Buzzards Bay Tidal Gauge and Sandwich Marina Tidal Gauge

<sup>31</sup> [https://www.mass.gov/doc/climate-change-projections-for-major-drainage-basins-in-massachusetts/download?\\_ga=2.238778053.495521431.1679920128-1282613598.1676906613](https://www.mass.gov/doc/climate-change-projections-for-major-drainage-basins-in-massachusetts/download?_ga=2.238778053.495521431.1679920128-1282613598.1676906613)

through the year 2100. Understanding temperate extremes above 120 degrees Fahrenheit are possible, adaptation measures will be taken to mitigate urban heat island effect across the Program Study Area. Adaptation measures would focus on nature-based solutions. Resources such as the Massachusetts Coastal Resilience Mapping Tool<sup>32</sup> would be used to inform where nature-based solutions can most effectively address extreme heat related hazards and contribute to resilience across the Program Study Area.

#### 8.1.4 Urban Flooding

RMAT identifies urban flooding as a High Exposure source of risk for the Program Study Area. This high-risk exposure score is derived from historic flooding in the Program Study Area, an anticipated increase in impervious area, and an anticipated increase in annual rainfall totals over the design life of the Program elements. A Program-specific, locally based, stormwater model is being developed to inform related Program elements, such as the design of the interchange approach networks and stormwater management, as well as to address potential impacts upon adjacent properties. Drawing from other sources such as the Massachusetts Coastal Resilience Mapping Tool,<sup>33</sup> MassDOT would identify where nature-based solutions can most effectively address natural hazards and contribute to resilience across the Program Study Area.

#### 8.1.5 Riverine Flooding

RMAT identifies riverine flooding as a High Exposure source of risk for the project area. This high-risk exposure score is derived from historic flooding in the Program Study Area, its location within the boundary of mapped FEMA floodplain, its location within 100-feet of a waterbody, and the potential for riverine erosion. A Program-specific, locally based, stormwater model is being developed to inform bridge design and related project infrastructure such as roadways, stormwater management design. Additionally, the model would be used to assess potential impacts to adjacent properties. Drawing from other sources such as the Massachusetts Coastal Resilience Mapping Tool,<sup>34</sup> MassDOT would identify where nature-based solutions can most effectively address natural hazards and contribute to resilience across the Program area.

### 8.2 Conformance with Regional Adaptation Strategies

The Program would contribute to regional adaptation strategies by implementing measures that align with the prioritizes of the Cape Cod Commission, Climate Action Plan (July 2021) and priorities set forth in the Town of Bourne Municipality Vulnerability Preparedness (MVP) Program Community Resilience Building Workshop. Section 8.2 addresses the consistency of the Cape Cod Bridges Program with regional adaptation strategies.

The Cape Cod Commission developed the *Climate Action Plan* (dated July 2021), which outlined goals to reduce greenhouse gas (GHG) emissions from the transportation sector and increase the resiliency of the existing transportation system to climate exposure hazards. The *Climate Action Plan* cites the importance of addressing vulnerabilities in public infrastructure, including adapting critical transportation infrastructure for climate change impacts, as a priority strategy. The *Climate Action Plan*

---

<sup>32</sup> <https://maps.coastalresilience.org/massachusetts/>

<sup>33</sup> <https://maps.coastalresilience.org/massachusetts/>

<sup>34</sup> <https://maps.coastalresilience.org/massachusetts/>



also identified the need for transportation infrastructure that promotes walking, biking, and public transit as an alternative to emissions-producing motor vehicle travel. To address GHG emissions reduction goals and promote alternatives to vehicular travel across Cape Cod Canal, the proposed replacement highway bridges will include provision of a barrier-separated, dedicated shared-use path for pedestrians and bicyclists to promote safe non-motor vehicular travel. MassDOT is designing the shared use paths to tie into the existing local bicycle-pedestrian facilities and roadway networks to the maximum extent possible.

In coordination with the Cape Cod Commission, the Town of Bourne conducted a working group in 2019 to develop 'priority actions' to improve resiliency to climate change. Community feedback included concerns over the adequacy of the Bourne and Sagamore bridges to serve as an evacuation route in the event of severe storms. The Town of Sandwich identified flood risk to regional transportation system as a key source of vulnerability in the community. Bridges throughout the region, and notably the Sagamore Bridge, was identified as an 'area of concern' for climate resiliency during the Town's 2018 Community Resiliency Building Workshop. The proposed Program would address the communities' priority actions. The separate bridge structures at each crossing provide a potential source of redundancy in case of an emergency evacuation in an event where a single bridge structure is compromised. MassDOT will continue to incorporate design features as the Program progresses to maximize climate resiliency.

### 8.3 Alternative Project Locations

The Program proposes to replace the existing Bourne and Sagamore bridges with new immediately adjacent twin bridges, which will minimize the extent of realignments to approach roadways and interchange ramps on the Cape and mainland sides of Cape Cod Canal. No alternative locations were considered regarding climate change risks, as the Bourne and Sagamore bridges provide the only roadway connections on and off Cape Cod, which is separated from the mainland by the Cape Cod Canal. All alternatives considered for providing safe and reliable long-term vehicular access across the Cape Cod Canal share similar high-risk exposure climate impacts relative to sea level rise, coastal storm surge, extreme heat, urban flooding, and riverine flooding. MassDOT will design the replacement highway bridges to account for SLR.

### 8.4 Potential Impacts to Floodwater Flow Paths, Velocities, Floodplain

The Bourne and Sagamore Program Study Areas are located within Land Subject to Coastal Storm Flowage (LSCSF) as defined in the MA WPA (refer to Figures 5-1 through 5-4 in Section 5). MassDOT is developing a Program-specific hydrologic model to assess coastal storm inundation and a Program-specific stormwater model for inland flood areas to better understand potential impacts to floodwater flow paths, velocities, and floodplain. Potential impacts will be evaluated in subsequent design stages and discussed in the DEIR, as applicable.

### 8.5 Next Steps

As needed, MassDOT will rerun the RMAAT Tool as design details, including construction start and stop, are confirmed. The DEIR will report adaptation solutions that MassDOT will develop for the following

high-risk exposures identified by the RMAT Tool: coastal storm surge, extreme heat, urban flooding, and riverine flooding.

As design advances, MassDOT will evaluate potential impacts to floodwater flow paths, velocities, and floodplain related to the Program. Results will be presented in the DEIR, as applicable.

## 9 Environmental Justice Section

The MEPA Office has finalized two MEPA Environmental Justice Protocols with effective dates of January 1, 2022.

- MEPA Public Involvement Protocol for Environmental Justice Populations
- MEPA Interim Protocol for Analysis of Project Impacts on Environmental Justice Populations

The protocols address the new public involvement and analysis requirements for projects undergoing MEPA review as set forth in: Sections 58 and 60 of Chapter 8 of the Acts of 2021: An Act Creating a Next-Generation Roadmap for Massachusetts Climate Policy (the “Climate Roadmap Act” or “the Act”); and the 2021 update to the MA EEA Environmental Justice Policy (the “2021 EJ Policy”). This section identifies the environmental justice (EJ) block groups within both one and five miles of the Cape Cod Bridges Program Study Areas, provides an overview of the character of the Study Areas, and describes the potential of the Program to result in impacts to EJ populations. A more detailed analysis will be completed for the DEIR.

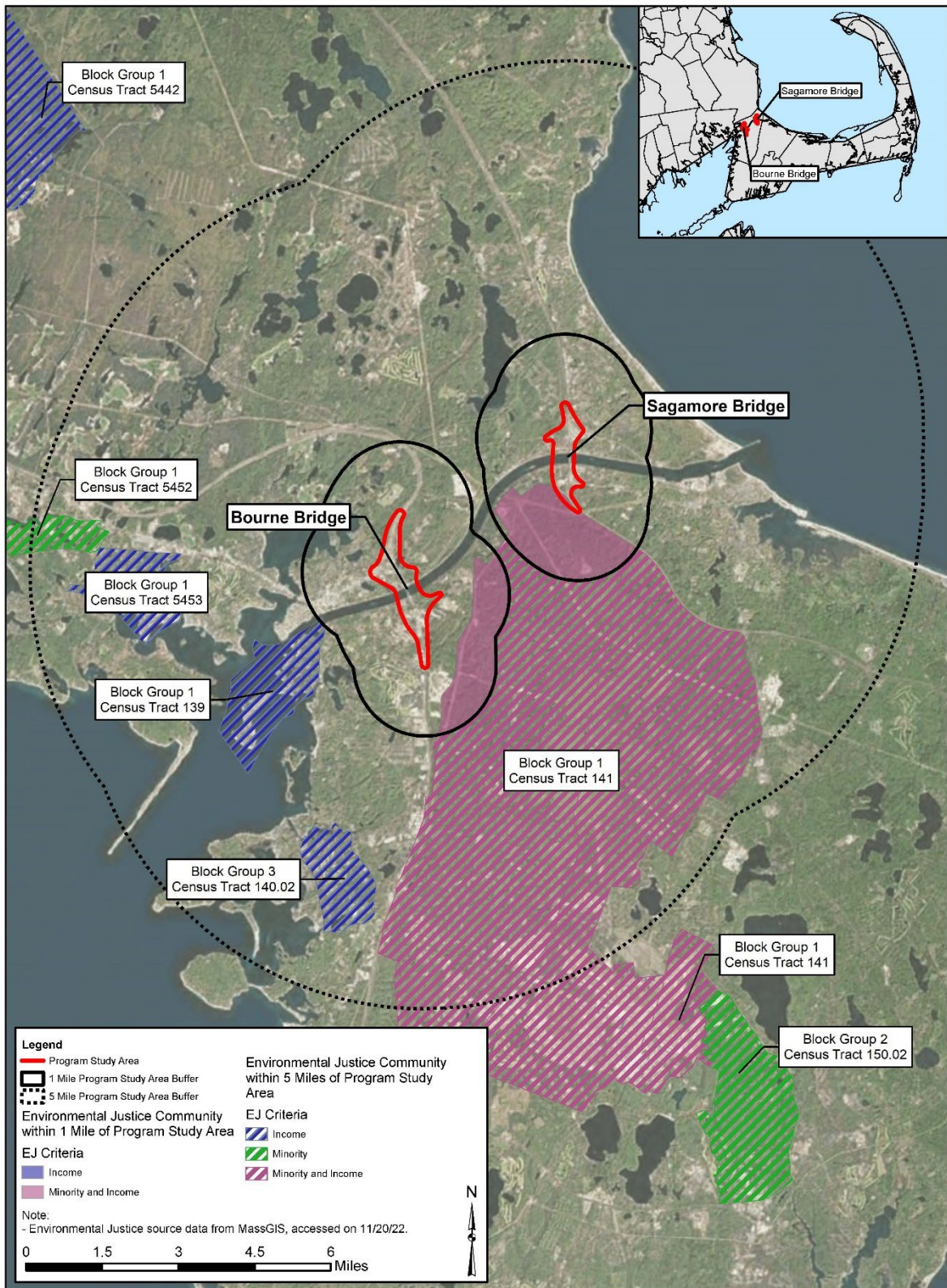
### 9.1 Identifying Characteristics of Environmental Justice Populations

This section describes the identifying characteristics of EJ populations within the Program Study Areas. In Massachusetts, an environmental justice population is a neighborhood where one or more of the following criteria are true:

- Criteria #1: the annual median household income is 65 percent or less of the statewide annual median household income
- Criteria #2: minorities make up 40 percent or more of the population
- Criteria #3: 25 percent or more of households identify as speaking English less than “very well”
- Criteria #4: minorities make up 25 percent or more of the population and the annual median household income of the municipality in which the neighborhood is located does not exceed 150 percent of the statewide annual median household income.

#### 9.1.1 Environmental Justice Populations and Characteristics within One Mile and Five Miles of the Program Study Areas

Figure 9-1 identifies all EJ populations in whole or in part within one and five miles of the Program Study Areas.



**Figure 9-1. Environmental Justice Communities within 1-mile and 5-miles of Program Study Areas**

Tables 9-1 and 9-2 identify EJ populations by Census data located within one and five miles of the Program Study Areas. Note that the municipality determination is made by the MA EEA, as the MA EEA-designated Towns differ from those U.S. Census-designated Places. As a result, a Census block group (BG) may overlap a town boundary [such as BG 1, Census Tract (CT) 141].

**Table 9-1. EJ Populations within One Mile of the Program Study Areas**

Census Geography	Municipality	EJ Criteria Met
<b>Block Group 1, Census Tract 141</b>	Bourne, Barnstable County	Minority and Income
<b>Block Group 1, Census Tract 141</b>	Sandwich, Barnstable County	Minority and Income

Source: <https://www.mass.gov/info-details/massgis-data-2020-us-census-environmental-justice-populations>

**Table 9-2. EJ Populations within Five Miles of the Program Study Areas**

Census Geography	Municipality	EJ Criteria Met
<b>Block Group 1, Census Tract 139</b>	Bourne, Barnstable County	Income
<b>Block Group 3, Census Tract 140.02</b>	Bourne, Barnstable County	Income
<b>Block Group 1, Census Tract 141</b>	Bourne, Barnstable County	Minority and Income
<b>Block Group 1, Census Tract 141</b>	Sandwich, Barnstable County	Minority and Income
<b>Block Group 1, Census Tract 5452</b>	Wareham, Plymouth County	Minority
<b>Block Group 1, Census Tract 5453</b>	Wareham, Plymouth County	Income

Source: <https://www.mass.gov/info-details/massgis-data-2020-us-census-environmental-justice-populations>

The EJ population within a one-mile radius of the Program Study Areas is associated with Joint Base Cape Cod (BG 1, CT 141). EJ populations within five miles of the Program Study Areas south of Cape Cod Canal include the Gray Gables (BG 1, CT 139) and Pocasset (BG 3, CT 140.02) neighborhoods in the town of Bourne. EJ populations within five miles of the Program Study Areas north of the canal include East Wareham (BG 1, CT 5452 and BG 1, CT 5453).

Table 9-3 presents select characteristics considered for environmental justice criteria for the BGs within five miles of the Program Study Areas. While all BGs meet Criteria #1, BG 1 in CT 5452 and CT 5453 also meet Criteria #4. The median household incomes (MHHI) for the EJ BGs are lower than both the municipality and county median household incomes in which they are located.

**Table 9-3. Select Characteristics of EJ BGs within Five Miles of the Program Study Areas**

BGs					Municipality	County
Census Geography	Total pop.	Number of households	Minority pop. (%)	MHHI (\$)	MHHI of Municipality (\$)	MHHI of County
BG 1, CT 139	596	361	4.7	42,569 (50.4%*)	\$76,823 (91%*)	\$76,863 (91%*)
BG 3, CT 140.02	713	447	4.5	31,266 (37.1%*)	\$76,823 (91%*)	\$76,863 (91%*)
BG 1, CT 141	797	306	32.5	53,108 (62.9%*)	\$76,823 (91%*)	\$76,863 (91%*)
BG 1, CT 5452	673	295	30.9	\$61,199 (72.5%*)	\$66,695 (79%*)	\$92,906 (110%*)
BG 1, CT 5453	1,617	631	23.9	\$33,614 (39.8%*)	\$66,695 (79%*)	\$92,906 (110%*)

Source: <https://www.mass.gov/info-details/massgis-data-2020-us-census-environmental-justice-populations>.

\*Represents the percentage of the MHHI for Massachusetts

### 9.1.2 Languages

The “Languages Spoken in Massachusetts” tab of the EJ Maps Viewer was reviewed to identify languages spoken within the Program Study Areas. The 2015 American Community Survey layer identifies CTs where at least five percent of the population has speakers who report that they do not speak English “very well,” aligning with the U.S. Department of Transportation’s “safe harbor” definition. This criterion is not met by CTs within one or five miles of the Program Study Areas. However, there are CTs within 13 miles of the Program Study Areas within the Cape Cod region meeting this criterion for Portuguese or Portuguese Creole in the town of Barnstable, Barnstable County. Additionally, the Massachusetts Department of Elementary and Secondary Education (DESE) layer showing languages spoken in the homes of public-school students by zip codes identifies Portuguese language speakers within the Sagamore Program Study Area.

### 9.1.3 Approved Languages for Public Involvement

Based on the “Languages Spoken in Massachusetts” mapping within the Cape Cod region and in coordination with the MassDOT Office of Diversity and Civil Rights, Spanish and Portuguese translation services have been provided and will continue to be available at all public information meetings. Relevant program materials, such as the Program comment forms and informational handouts, have been and will continue to be translated into Spanish and Portuguese. American Sign Language and Communication Access Realtime Translation (CART) services have been and will continue to be provided at all public meetings. All other translation services of meetings and materials continue to be available upon request.

### 9.1.4 Existing Unfair Inequitable Environmental Burdens

The Massachusetts Department of Public Health Environmental Justice Tool (MA DPH EJ Tool) facilitates the use of the EEA EJ Policy by identifying health outcome data classified by location (e.g., state, county, or CT). The vulnerable EJ health criteria for childhood lead exposure and low birth weight

are evaluated at the CT level. The vulnerable EJ health criteria for childhood lead exposure or low birth weight are not met by CTs located in whole, or in part, within one mile of the Program Study Areas.

The vulnerable EJ health criteria for heart attacks and childhood asthma are evaluated at the municipal level for those municipalities located in whole, or in part, within one mile of the Program Study Areas (Bourne, Sandwich, and Wareham). The vulnerable EJ health criterion for heart attacks is met for Bourne. The vulnerable EJ health criteria for both heart attacks and childhood asthma are met for Wareham. Table 9-5 provides further vulnerable EJ health criteria details.

**Table 9-5. Vulnerable EJ Health Criteria**

Municipality	Health outcome	Year range	Municipality rate	110 percent of statewide rate	Vulnerable Health EJ Criteria met by at least one block group
<b>Bourne</b>	Heart Attack	2013-2017	36.8	29.1	Yes
<b>Wareham</b>	Heart Attack	2013-2017	43.5	29.1	Yes
<b>Wareham</b>	Childhood Asthma	2013-2017	98.1	91.4	Yes

Source: <https://www.mass.gov/info-details/massgis-data-2020-us-census-environmental-justice-populations>

## 9.2 Overview of Adjacent Communities

Figure 9-2 shows the general location of the villages within the vicinity of the Program Study Areas. The areas are outlined by zip code, as not all communities in Bourne are defined Census designated places. The land bordering the canal on either side is dedicated to the Cape Cod Canal FNP.

On the north side of the canal ("off-Cape"), moving west to east, are the more commercialized villages of Buzzards Bay (west of Route 25) and Bournedale (east of Route 25 and west of Route 3) in Bourne, as well as the seaside village of Sagamore Beach (east of Route 3) in Sagamore. The southeastern-most area off-Cape and north of Cape Cod Canal is within the town of Sandwich; it is largely dedicated to open space land owned by the Town of Sandwich or the USACE.

On the south side of the canal ("on-Cape") west of Route 28, and moving north to south, are the seaside villages of Gray Gables (containing EJ BGs), Monument Beach, Pocasset (containing EJ BGs), and Cataumet in Bourne. The area between Route 28 and Route 6 along Sandwich Road in Bourne is interspersed with community resources and rural streets with single family lots, while the remainder of land to the south is primarily dedicated to the Massachusetts Military Reservation (MMR), Camp Edwards Training Area, which is part of JBCC (containing EJ BGs). The area of Bourne around Route 6 near the Sagamore Bridge is within the southern portion of Sagamore village. To the east is the town of Sandwich.



As shown in Table 9-6, the communities in and adjacent to the Program Study Areas are generally less urbanized with median ages that are typically above that of the statewide median age of 39.6 for Massachusetts. The populations are predominantly white alone, with Hispanic or Latino persons generally comprising the largest proportions of minority populations in each village or town. These adjacent communities are generally less diverse as compared to Massachusetts.

**Table 9-6. Demographics Profiles - Communities within the Vicinity of the Program Study Areas**

Demographics	Buzzard's Bay and Gray Gables (02532)	Sagamore north of the Canal, Sandwich north of the Canal (02562)	Monument Beach (02553)*	Pocasset (02559)	Cataumet (02534)	MMR Camp Edwards Training Area (02542)	Sagamore south of the Canal (02561)	Sandwich (02563)	East Sandwich (02537)	Massachusetts
<b>Total Population (#)</b>	<b>13,443</b>	<b>2,814</b>	<b>96</b>	<b>3,228</b>	<b>1,082</b>	<b>948</b>	<b>257</b>	<b>9,728</b>	<b>6,824</b>	<b>6,873,003</b>
Median age (years) of population	52.9	42.1	-	59	52.4	25.5	56	54.4	44.3	39.6
<b>Percent Hispanic or Latino (of any race)</b>	<b>3.1</b>	<b>3.4</b>	<b>-</b>	<b>0.3</b>	<b>6.7</b>	<b>9.4</b>	<b>-</b>	<b>2.4</b>	<b>0.5</b>	<b>12</b>
Mexican	0.1	-	-	-	4.0	1.9	-	0.3	-	0.7
Puerto Rican	0.9	-	-	-	1.4	2.2	-	1.4	0.3	4.7
Cuban	0.1	0.9	-	-	-	-	-	-	0.2	0.2
Other Hispanic or Latino	1.9	2.6	-	0.3	1.3	5.3	-	0.7	-	6.4
<b>Percent Not Hispanic or Latino</b>	<b>96.9</b>	<b>96.6</b>	<b>100.0</b>	<b>99.7</b>	<b>93.3</b>	<b>90.6</b>	<b>100.0</b>	<b>97.6</b>	<b>99.5</b>	<b>88.0</b>
White alone	87.0	88.7	100.0	99.2	91.2	81.2	100.0	90.7	89.7	70.8
Black or African American alone	1.0	0.6	-	0.3	2.1	3.1	-	0.2	4.4	6.8
American Indian and Alaska Native alone	0.3	-	-	-	-	-	-	0.4	-	0.1
Asian alone	2.6	5.4	-	-	-	2.7	-	2.3	4.2	6.7
Native Hawaiian and Other Pacific Islander alone	-	-	-	-	-	-	-	-	-	0.0
Some other race alone	3.8	0.2	-	-	-	-	-	2.4	-	0.8
Two or more races	2.3	1.6	-	0.2	-	3.6	-	1.5	1.2	2.7

Source: Table DP05: ACS DEMOGRAPHIC AND HOUSING ESTIMATES (2020 5-Year Estimates)

\*Monument Beach data is limited.



Most housing units in each municipality are owner-occupied, as shown in Table 9-7, with higher home ownership in and near the Program Study Areas as compared to Massachusetts. Many households include individuals that are at least 60 years of age, consistent with an older average population as compared to the statewide average. The communities of Sagamore north of the canal and Sandwich north of the canal have the largest proportion of households with one or more individual under 18 years old.

**Table 9-7. Household Profiles - Communities within the Vicinity of the Program Study Areas**

Households	Buzzard's Bay and Gray Gables (02532)	Sagamore north of the Canal, Sandwich north of the Canal (02562)	Monument Beach (02553)	Pocasset (02559)	Cataumet (02534)	MMR Camp Edwards Training Area (02542)	Sagamore south of the Canal (02561)	Sandwich (02563)	East Sandwich (02537)	Massachusetts
<b>Total households (#)</b>	<b>5,950</b>	<b>1,151</b>	<b>96</b>	<b>1,596</b>	<b>369</b>	<b>306</b>	<b>105</b>	<b>4,099</b>	<b>2,518</b>	<b>2,913,009</b>
Owner-occupied housing units (%)	77.7	81.1	100	73.2	91.1	5.2	74.3	87	93	62.5
Renter-occupied housing units (%)	22.3	18.9	-	26.8	8.9	94.8	25.7	13	7	37.5
Households with one or more people under 18 years (%)	17.6	29.3	-	16.2	25.2	61.4	13.3	20.8	25.6	28.8
Households with one or more people 60 years and over (%)	58.1	39	100	69	59.9	0	86.7	61.2	49.8	41.1
Householder living alone (%)	35.8	19.6	100	39.5	11.4	11.1	40	25.8	21.4	28.4
Householder living alone - 65 years and over	16.4	8.6	100	27.4	2.4	0	40	16.4	10.4	12.1

Source: Table S1101: HOUSEHOLDS AND FAMILIES (2020 5-Year Estimates)

A large portion of the population does not participate in the workforce within the Program Study Areas and the median ages of workers is generally closer to 50 years of age, as shown in Table 9-8, indicating that the permanent population likely includes many retired individuals. Median earnings are typically above the low-income threshold. More workers are employed in educational services, and health care

and social assistance; followed by arts, entertainment, and recreation, and accommodation and food services; professional, scientific, management, and administrative and waste management services; and retail. While more than half of workers in the area are employed within their county of residence, a large proportion travel outside of their county of residence for work. Most households own at least one vehicle. However, nearly half of workers in the Sagamore community south of the bridge do not own a car. There is less of a pattern regarding commute times for workers. The areas south of the Canal have a high proportion of workers commuting less than 10 minutes to work. There are around 10 percent or more of workers commuting 60 or more minutes from many of the areas. Reportedly no workers from Sagamore south of the Canal commute 60 minutes or more, with most commuting between 24 and 59 minutes.

**Table 9-8. Employment Profiles - Communities within the Vicinity of the Program Study Areas**

Employment Information for Workers 16 Years and Over	Buzzard's Bay and Gray Gables (02532)	Sagamore north of the Canal, Sandwich north of the Canal (02562)	Monument Beach (02553)	Pocasset (02559)	Cataumet (02534)	MMR Camp Edwards Training Area (02542)	Sagamore south of the Canal (02561)	Sandwich (02563)	East Sandwich (02537)	Massachusetts
<b>Total number of workers (#)</b>	<b>6,853</b>	<b>1,725</b>	<b>-</b>	<b>1,524</b>	<b>403</b>	<b>425</b>	<b>199</b>	<b>5,348</b>	<b>3,123</b>	<b>3,815,083</b>
Median age (years)	49.7	45.1	-	50.8	50.7	30.1	49.4	53.4	47.6	-
<b>Not in Labor Force (#)</b>	<b>4,187</b>	<b>582</b>	<b>-</b>	<b>1,297</b>	<b>537</b>	<b>188</b>	<b>58</b>	<b>3,079</b>	<b>2,145</b>	<b>1,862,942</b>
<b>Earnings in the past 12 months</b>										
\$1 to \$9,999 or less (%)	9.8	14.5	-	2.9	9.4	13.2	7	12.4	13.4	10.4
\$10,000 to \$14,999 (%)	4.5	4.8	-	6.4	17.4	0	17.1	4.8	5.5	4.8
\$15,000 to \$24,999 (%)	13.7	2.8	-	14.9	0	10.4	0	11.6	3.7	9.5
\$25,000 to \$34,999 (%)	12.6	12	-	18.5	4.7	15.8	13.1	11.3	2.8	10.5
\$35,000 to \$49,999 (%)	14.4	15.5	-	12.7	4.7	23.8	9.5	13.9	13.4	14
\$50,000 to \$64,999 (%)	13.5	13.6	-	11.1	13.4	19.8	7	11.2	10.4	12.7
\$65,000 to \$74,999 (%)	8.3	3.4	-	4.7	19.1	2.1	24.6	6.8	7.9	6.5
\$75,000 or more (%)	23.3	33.4	-	28.8	31.3	15.1	21.6	28	42.9	31.5
Median earnings (dollars)	44,026	50,193	-	41,350	65,129	38,064	61,161	43,440	65,600	50,627
Total at or above 150 percent of the poverty level (%)	94	91.6	-	96.5	85.9	89.2	100	95.4	97.3	92.8

Employment Information for Workers 16 Years and Over	Buzzard's Bay and Gray Gables (02532)	Sagamore north of the Canal, Sandwich north of the Canal (02562)	Monument Beach (02553)	Pocasset (02559)	Cataumet (02534)	MMR Camp Edwards Training Area (02542)	Sagamore south of the Canal (02561)	Sandwich (02563)	East Sandwich (02537)	Massachusetts
<b>Percent of workers by industry</b>										
Construction	11	6	-	10	0	0	7	9	8	6
Manufacturing	6	5	-	7	18	0	0	6	8	9
Wholesale trade	5	3	-	1	0	1	8	5	3	2
Retail trade	15	15	-	7	9	5	8	12	8	10
Transportation and warehousing, and utilities	5	5	-	5	0	0	0	7	2	4
Information and finance and insurance, and real estate and rental and leasing	6	11	-	2	5	1	16	8	9	10
Professional, scientific, management, and administrative and waste management services	9	12	-	17	11	5	10	9	9	15
Educational services, and health care and social assistance	23	22	-	29	29	12	14	25	37	28
Arts, entertainment, and recreation, and accommodation and food services	12	13	-	15	15	4	17	9	7	8
Other services (except public administration)	3	3	-	6	4	0	0	2	5	4
Public administration	4	4	-	1	9	5	22	9	4	4
Armed forces	1	1	-	0	0	67	0	1	1	0
<b>Place of work (%)</b>										
Worked in county of residence percent	64.1	52.8	-	76.2	60.3	93.9	67.3	75.2	72.6	-

Employment Information for Workers 16 Years and Over	Buzzard's Bay and Gray Gables (02532)	Sagamore north of the Canal, Sandwich north of the Canal (02562)	Monument Beach (02553)	Pocasset (02559)	Cataumet (02534)	MMR Camp Edwards Training Area (02542)	Sagamore south of the Canal (02561)	Sandwich (02563)	East Sandwich (02537)	Massachusetts
Worked outside county of residence percent	34.5	46.3	-	23	39.7	4.7	32.7	19.5	22.8	-
<b>Vehicles available by household (%)</b>										
No vehicle available	2	1	0	10	0	0	40	1	6	6
1 vehicle available	41	22	100	35	11	28	16	27	23	23
2 vehicles available	36	56	0	35	49	69	12	44	43	42
3 vehicles available	15	17	0	8	19	2	0	19	19	-
4 or more vehicles available	5	4	0	12	21	0	31	8	9	-
<b>Commute to work by car (%)</b>										
Less than 10 minutes	15.6	10.2	-	25.1	21.5	39.4	33.2	19.2	5.3	10.3
10 to 14 minutes	12.1	8	-	7.4	4.1	16.8	0	12.7	12.9	11.5
15 to 19 minutes	14.9	10.1	-	11.1	10.3	5.1	8	11.4	20.1	12.7
20 to 24 minutes	11.1	13.8	-	13.9	14.1	6.4	0	17	16.3	12.4
25 to 29 minutes	11.9	6.8	-	7	0	25.2	7.5	7.8	5.3	5.9
30 to 34 minutes	11.2	21.4	-	5.1	9.2	0	24.1	10.4	12.5	14.0
35 to 44 minutes	4.3	7.9	-	6.2	15.5	0	9.6	3.6	5.1	8.6
45 to 59 minutes	8.9	11.2	-	5.7	7.3	2.3	17.6	4.9	7.4	10.9
60 or more minutes	9.9	10.7	-	18.6	17.9	4.8	0	13	15.2	13.7

Source: Table S2001: EARNINGS IN THE PAST 12 MONTHS (IN 2020 INFLATION-ADJUSTED DOLLARS) (2020 5-Year Estimates); TABLE S0804: MEANS OF TRANSPORTATION TO WORK BY SELECTED CHARACTERISTICS FOR WORKPLACE GEOGRAPHY (2020 5-Year Estimates)

\*Monument Beach data is limited.

Outdoor community resources exist within the areas surrounding the bridges on either side of the canal. The canal and bordering land serve as a hub of activity in Bourne by providing opportunities for scenic views and recreational activities, including boating, fishing, walking, biking, in-line skating, birdwatching, and picnicking. There are access spots, viewing areas, and rest facilities along the length of the waterway. The Buzzard's Bay downtown area serves as the Main Street for Bourne and the economic

and governmental center of the area. There are few grocery stores within the vicinity of the bridges. The Bourne Intermediate, Middle School, and High School are collocated to the southwest of the Bourne Rotary South, while the Bourne Elementary School is located off-Cape along Route 6 between the Bourne and Sagamore bridges. Bourne public school buses run on either side of the Canal to and from the respective schools. The area has many assisted living facilities, consistent with a higher proportion of older adults. Other community facilities are scattered throughout, consistent with a dependence on vehicular travel. The area is served by public transportation through the CCRTA; services include fixed routes connecting the 15 communities of Cape Cod, Dial-A-Ride Transportation door-to-door service, SmartDart ride-hail service for Yarmouth and Barnstable, CapeFLYER summer weekend passenger train from South Station to Hyannis with an initial stop in Bourne, Boston Hospital Transportation from Cape Cod to all major hospitals in the Boston area, and ADA Paratransit services for those whose disabilities prevent them from using CCRTA's accessible fixed route buses. These facilities for intermodal travel are interspersed throughout the area.

## 9.3 Potential Effects on Environmental Justice Populations

### 9.3.1 Program Benefits

Overall, the Cape Cod Bridges Program would improve cross-canal mobility and accessibility and traffic operations and safety within the Cape Cod Canal area roadway system. The replacement bridges would simplify inspection and maintenance and maximize resiliency. The transportation improvements would facilitate military training and/or response missions that are critical to national security. Additionally, it is anticipated that the Program would improve emergency vehicle response times and the ability to expedite traffic off Cape Cod in the event of an emergency.

Improving connectivity and mobility across the canal are essential to maintaining livability and quality of life on Cape Cod. Travel via the bridges represents an important part of the daily commute for employees living off-Cape. As reported in MassDOT's CCTS, almost 34,000 commuters in Barnstable County use either the Bourne or Sagamore bridges each workday as part of their daily commute, including over 32 percent of workers in Bourne and 19 percent of workers in Sandwich. Nearly 90 percent of those commuters use private automobiles to travel to work, accounting for the most important component of commuter transportation. Additionally, employees of on-Cape businesses commute to work from the surrounding off-Cape urban areas of New Bedford, Plymouth, Brockton, Fall River, and other communities with historically underrepresented groups and unemployment higher than the state average. For on- and off-Cape residents, anticipated travel time savings from reduced congestion would provide positive economic benefits, as well as an improved quality of life.

The Program would provide new ADA-compliant shared used paths along the bridges and to the approach network access roads. MassDOT is designing the shared use paths to tie into the existing local bicycle-pedestrian facilities and roadway networks, and address gaps in accessible connections, to the maximum extent possible. These efforts would support an overall goal of creating an integrated multimodal transportation system for Cape Cod, which would benefit the local and regional economy.

### 9.3.2 Overall Potential Impacts and Mitigation Measures

The Cape Cod Bridges Program is anticipated to take approximately eight years to complete. Therefore, MassDOT is evaluating Program design options that would maximize constructability, reduce complexity relative to staging and the need for temporary structures, and limit impacts upon the traveling public. As indicated in Section 2.3, bridge construction would include maintaining two traffic lanes in each direction at each crossing and maintaining connections to the local roadway network. The Program would deploy Smart Work Zones and real-time traffic management devices to manage traffic and increase safety for construction workers and the traveling public. Sensors, cameras, and changeable message signs would be deployed to provide real-time information to motorists such as travel times, speed warnings, dynamic merge feedback, queue warnings, and truck warnings.

The proposed improvements would not trigger ENF or mandatory EIR review thresholds for air quality, hazardous waste, or wastewater. Due to the replacement of the NRHP-eligible Bourne and Sagamore bridges, the Program would result in an Adverse Effect to these two historic resources under Section 106 of the NHPA. MassDOT is designing the bridge replacements to avoid and/or minimize impacts to the NRHP-eligible Cape Cod Canal District. The following list describes those MEPA review thresholds (310 CMR 11.03) that are anticipated to be triggered by the Program:

- 301 CMR 11.03(1)(a)1. Direct alteration of 50 or more acres of land.
- 301 CMR 11.03(1)(a)2. Creation of ten or more acres of impervious area.
- 301 CMR 11.03(6)(b)1.b. Widening of an existing roadway by four or more feet for one-half or more miles.
- 301 CMR 11.03(6)(b)2.a. Construction/widening of a roadway or its right-of-way that will alter the bank or terrain located ten more feet from the existing roadway for one-half or more miles.
- 301 CMR 11.03(6)(b)2.b. Construction/widening of a roadway or its right-of-way that will cut five or more living public shade trees of 14 or more inches in diameter at breast height.

Throughout Program design, MassDOT would incorporate measures to avoid and minimize impacts to protected resources. For unavoidable impacts, MassDOT would provide mitigation in consultation with the applicable resource agencies.

Right-of-way impacts have been evaluated based on conceptual design. None of the takings potentially required for the Program are anticipated to occur within EJ designated areas. As design advances and impacts are confirmed, MassDOT proposes to implement the right-of-way acquisition process in compliance with the Relocation Assistance and Real Property Acquisition Policies Act of 1970 (Uniform Act) (amended in 1987), and Massachusetts General Laws, primarily Chapter 79.

MassDOT is committed to ensuring that no person is excluded from participation, denied benefits, or otherwise subjected to discrimination, regardless of race, color, national origin, sex, age, or disability. The MassDOT Title VI/Nondiscrimination Program for FHWA oversees civil rights compliance in the

Massachusetts Highway Division. MassDOT has a Diversity and Civil Rights External Operations Program for federally funded projects.

In coordination with FHWA and MEPA, MassDOT developed a robust Public Involvement Plan (PIP) guided by the principles of comprehensive outreach, as well as a Community Demographic Analysis and Engagement Plan. Together, the PIP and the Community Demographic Analysis and Engagement Plan set forth measures of effectiveness that are used to evaluate outreach and adapt as needed, particularly in historically underserved communities.

### **9.3.3 Anticipated Effects upon Environmental Justice Communities**

There are no displacements anticipated to occur within EJ populations. The improvements to travel patterns across the bridges and reduced congestion at the interchanges could serve to decrease the sense of separation between the portions of Bourne located to the north and south of the canal. Additionally, improvements at the interchanges would increase east-west connectivity on either side of the canal. It is anticipated the safety and design upgrades to facilities for alternative modes of travel and new portions of multimodal facilities would increase trips by pedestrians and bicyclists, which could contribute positively to health outcomes in the area. These benefits would be experienced by both EJ and non-EJ populations.

The Program would correct existing operational deficiencies and improve safety conditions at the bridges and approach intersections, thereby reducing congestion, improving travel times, and maintaining and enhancing connectivity. Proposed improvements to critical transportation infrastructure and multimodal connectivity within the vicinity of Cape Cod Canal would facilitate the safer, more efficient, and dependable movement of people, goods and services to and from Cape Cod, which is essential to enhancing public safety, social welfare, and economic development in the Cape Cod region. In consideration of the overall transportation, public safety, and quality of life benefits to the immediate locale and region, disproportionately high and adverse impacts to EJ populations are not anticipated.

## **9.4 Public Involvement Activities**

The following describes the Program's public involvement (PI) activities conducted to date.

### **9.4.1 MEPA Advance Notice**

Consistent with 301 CMR 11.05(4), any project that (i) meets or exceeds mandatory EIR thresholds, or (ii) will seek to avail itself of expedited review procedures under 301 CMR 11.06(8) and (13), must provide advance notification of the project no later than 45 days, and no earlier than 90 days, prior to filing the ENF. The advance notification takes the form of a completed "EJ Screening Form" that is to be provided to the list of contacts on the EJ Reference List as detailed in Attachment 9-1. The EJ Reference List was requested from the EEA EJ Director and the MEPA Office through emailed correspondence to [MEPA-EJ@mass.gov](mailto:MEPA-EJ@mass.gov). The MEPA Office notes the EJ Reference List should be utilized as a starting point, not as a "definitive" contact list. Therefore, additional organizations and community organizations that have been coordinated with through the outreach process were added. Although translations were not required, the EJ Screening Form and accompanying email was translated into Spanish and Portuguese.

The accompanying email explained the purpose of the notification and was translated into English, Spanish, and Portuguese.

Those listed on the EJ Reference List for the Program were sent the advanced notification on Monday, March 13, 2023. The EJ Screening Form provides opportunity for written comments and a method for contacting to request a formal briefing. To date, no requests have been received. In addition to the advanced notification, robust outreach is conducted prior to public events and meetings, as described in Section 9.4.2, to reach historically underserved populations that may experience barriers to participation.

#### **9.4.2 Program Outreach**

Since the 2020 signing of the MOU, USACE and MassDOT have worked in partnership to utilize both traditional and non-traditional outreach strategies for engaging the public in the Cape Cod Bridges Program. MassDOT and USACE meet with FHWA on a recurring basis to discuss program status and make decisions deliberately and collaboratively. MassDOT and USACE have a strong history of collaboration and continue to partner with jurisdictional stakeholders to understand community needs and ensure that meaningful benefits are being created. Prior to the formal launch of the PI process, the Program team met with legislators and targeted stakeholders, including the Cape Cod Metropolitan Planning Organization, Regional Transit Authorities, Regional Planning Agencies, Chambers of Commerce, and the Town of Bourne to apprise them of the previous USACE and MassDOT planning processes for the bridge replacements and approach roadway network improvements. Informal meetings were also held with representatives of the Mashpee Wampanoag Tribe, the Wampanoag Tribe of Gay Head (Aquinnah), and the Herring Pond Wampanoag Tribal Council during the MassDOT Cape Cod Transportation Study.

MassDOT developed the Cape Cod PIP, provided as Attachment 9-2, at the onset of the Program in September 2021. The purpose of the PIP is to guide the public involvement process in compliance with the outreach strategies set forth by MassDOT's overarching Public Participation Plan and recent guidance developed for Virtual Public Involvement (VPI) practices. MassDOT continues to execute robust public involvement efforts through the Program PIP to engage as many diverse people and communities as possible. MassDOT has identified historically underrepresented populations that may be impacted by the Program to support public outreach efforts and Program planning. For example, MassDOT recognizes the diversity in age demographics on Cape Cod. Due to the significance in older populations, all engagement materials are prepared well in advance to accommodate different mobility and technology needs. The Program team provides call-in options for all virtual meetings and notifies local councils on aging of upcoming public meetings to engage these populations.

Prior to meetings, communications methods that are used are as follows:

- Emails: Sent to stakeholders and interested parties to provide program updates, public meeting notifications and reminders, meeting invites and coordination, and details on upcoming outreach activities



- Letters: Notifying individuals of field work and providing formal response to stakeholder comments or inquiries
- Phone calls: Responding to stakeholder phone call inquiries and coordinating stakeholder meetings
- Press releases: Notifying media outlets of important Program milestones, developments, and public meetings
- Newspaper advertisements: Included in print and digital publications in English and non-English languages to advertise public meetings.

To date, the Program PI program has involved five rounds of public meetings. Rounds 1 through 4 each consisted of two identical meetings. The Round 1 public outreach was launched in June 2021 and attended by 686 individuals. It was followed by Round 2 public outreach held in November 2021 and attended by 566 individuals, Round 3 public outreach held in November 2022 and attended by 1,257 individuals, and Round 4 public outreach held in January 2023 and attended by 991 individuals. The two Round 5 public outreach meetings were held in March 2023 and were attended by 694 individuals; the first meeting focused on Bourne crossing updates and the second meeting focused on Sagamore crossing updates. In total, 4,193 individuals attended these five rounds of meetings. MassDOT anticipates that future round of public outreach will follow.

Each round of public outreach includes a presentation by MassDOT, followed by an extensive question and answer period, with opportunities presented to submit written comments via the Program website, email, and U.S. mail. Additionally, for each round of outreach, legislative briefings and targeted stakeholder meetings are conducted to identify concerns and shape the presentations for public meetings, to ensure the content being presented is responsive to the concerns and questions of these organizations' constituencies. To date, all meetings have been held virtually. During and following each public meeting, MassDOT collects comments from the public through Public Involvement Management Application (PIMA), a cloud-based tool for tracking engagement data and comment topics. The PIMA data is then used to determine salient topics for future public information meetings.

Communication during all previous and planned meetings has and will continue to be two-way, ensuring that equal opportunity is provided for all participants to both listen to the presentation, ask questions, and receive answers regardless of language or ability. Each public information meeting includes Spanish, Portuguese, American Sign Language, and Communication, Access, Realtime Translation (CART) interpreters; other language interpreters and services are available by request. Additionally, dial in service is available for individuals without internet access.

As of April 17, 2022, MassDOT has received over 1,700 comments and questions related to the Cape Cod Bridges Program from the online comment form, emails, phone calls, and public meetings. This has included feedback on a wide variety of topics including construction, cost, traffic impacts, bridge design, right of way, and numerous other subjects.

MassDOT has utilized polls during public meetings to encourage effective participation. For instance, in Round 2, participants were asked to select their top three priorities for improvements based on the list of Program needs, which resulted in most people selecting “Structural Condition,” “Traffic Operations,” and “Traffic Safety.” When asked to select the most effective outreach strategy, email was ranked number one, followed by social media.

In addition to the rounds of public information meetings, MassDOT offers meetings to interested parties, including abutting businesses, to directly receive input and provide information. This has included meetings with representatives from Market Basket and Christmas Tree Shops. Further, MassDOT conducts reviews of “lessons learned” from each round of outreach to broaden the effectiveness of public engagement.

MassDOT advertises all public meetings in advance through an email to the stakeholder database comprised of 4,000 persons and entities, which is detailed below. The meetings are advertised in English and non-English in several newspapers, including *Portuguese Times*, *El Planeta*, *Provincetown Independent*, *Provincetown Banner*, *Cape Cod Chronicle*, *Cape Cod Times*, *Bourne Enterprise*, and *Barnstable Patriot*. The cumulative circulation of these outlets is over 250,000 readers. Facebook, Instagram, and Twitter have been used to expand the reach of engagement by appealing to demographics who may be less likely to respond to newspaper advertisements or physical mail.

Prior to Round 3, MassDOT conducted an analysis of engagement effectiveness to analyze and improve methods of community outreach. As a result, community organizations representing EJ groups on Cape Cod and the Islands were thoroughly researched and communicated with one-on-one via phone and email. Some of these groups include the Cape Organization for the Rights of the Disabled, Sandwich Council on Aging, Woods Hole Diversity Advisory Committee, and Cape Cod Pride.

The Round 4 public information meetings in January 2023 included a discussion of the status of the Program, bridge types, proposed bridge lane configurations, potential bridge locations, and next steps. The meetings included robust discussions, with questions focused on topics such as highway alignment, right of way impacts, multimodal accommodations, and bridge design. These meetings were attended by a total of 991 individuals.

The Round 5 public information meetings were held in March 2023. The first meeting of this round of public engagement included a presentation on the status of the Program, interchange alternatives for the Bourne Bridge, and next steps. The second meeting consisted of a presentation about the program status, interchange alternatives for the Sagamore Bridge, and next steps. Each meeting included a questions and answer portion on topics such as right-of-way impacts, potential roadway changes, multimodal accommodations, and traffic. These meetings were attended by a total of 694 individuals.

The five rounds of meetings were therefore attended by a cumulative total of 4,193 individuals. In response to comments and questions received during the Rounds 1 through 4 public information

sessions, MassDOT created and distributed via email two different Cape Cod Bridges Program Frequently Asked Questions (FAQ) Sheets in addition to individualized responses as provided in Attachment 9-3 and 9-4. MassDOT will continue to provide and expand the accessibility and language accommodations procured in Rounds 1 through 5 throughout the duration of Program design. As design advances, MassDOT will continue to provide opportunities for the public to provide input on Program recommendations through the Program website, which can be found at: <https://www.mass.gov/cape-bridges>. The Program website provides the public with opportunities to give feedback on all steps of the Program design and evaluation process.

Additionally, MassDOT will be holding an informal, in-person “Open House” in May 2023 to provide the public with the opportunity to meet with Program team, ask questions, and learn about Program updates in an informal setting. Open houses are beneficial as they afford the Program team more flexibility and creativity in providing meaningful experiences for stakeholder participation, and they provide an opportunity for stakeholders to interact with each other and the Program team in an organized and engaging setting.

Information on the public meetings and targeted public events is provided in Tables 9-9 and 9-10.

**Table 9-9. Program Public Meetings**

Outreach	Public Meeting	Date	Topics
Round 1 Outreach	Public Information Meeting	June 29, 2021	<ul style="list-style-type: none"> <li>Field investigations data collection</li> <li>Regional transportation improvement needs</li> <li>Program scope and timeline</li> </ul>
		June 30, 2021	
Round 2 Outreach	Public Information Meeting	November 16, 2021	<ul style="list-style-type: none"> <li>Draft Purpose and Need</li> <li>Draft Measures of Effectiveness</li> <li>Draft Analyses</li> </ul>
		November 18, 2021	
Round 3 Outreach	Public Information Meeting	November 15, 2022	<ul style="list-style-type: none"> <li>Purpose and Need</li> <li>Bridge Types</li> <li>Program Updates</li> <li>Next Steps</li> </ul>
		November 17, 2022	
Round 4 Outreach	Public Information Meeting	January 24, 2023	<ul style="list-style-type: none"> <li>Program status</li> <li>Bridge types</li> <li>Proposed bridge lane configurations</li> <li>Potential bridge locations</li> <li>Next steps</li> </ul>
		January 26, 2023	
Round 5 Outreach	Public Information Meeting	March 22, 2023	<ul style="list-style-type: none"> <li>Program Status</li> <li>Interchange Alternatives - Bourne Crossing</li> <li>Next Steps</li> </ul>
		March 29, 2023	

Outreach	Public Meeting	Date	Topics
Open House	Public Information Meeting	May 17, 2023 (pending)	<ul style="list-style-type: none"> <li>Meet the Program Team</li> <li>Program Status</li> <li>Next Steps</li> </ul>

**Table 9-10. Program Targeted Public Events**

Event	Date
State Legislative Briefing	March 26, 2021
Town of Bourne Briefing	April 8, 2021
ACEC Meeting	May 7, 2021
Federal Delegation Briefing	May 10, 2021
Military-Civilian Community Council (MC3) Joint Base Cape Cod (JBCC)	May 12, 2021
Cape Cod Commission Briefing	June 21, 2021
Cape Cod Metropolitan Planning Organization Briefing	June 21, 2021
Regional Transit Authorities Briefing	June 21, 2021
Regional Planning Agencies Briefing	June 21, 2021
Cape Cod Canal Chamber, Cape Cod Chamber of Commerce, and Town of Bourne Briefing	June 23, 2021
State and Federal Legislative Briefing	November 1, 2021
Town of Bourne Briefing	November 3, 2021
Chambers of Commerce Briefing	November 9 2021
Regional Planning Agencies Briefing	November 10, 2021
Regional Transit Authorities Briefing	November 10, 2021
Federal Delegation Briefing	October 25, 2022
State Delegation Briefing	October 27, 2022
Regional Transit Authorities Briefing	November 7, 2022
Regional Planning Agencies Briefing	November 8, 2022
Chamber of Commerce Briefing	November 9, 2022
Town of Bourne Briefing	November 9, 2022
Cape Cod Commission Briefing	January 17, 2023
Town of Bourne Briefing	January 17, 2023
Cape Cod Chamber of Commerce Briefing	January 18, 2023
Regional Transit Authorities and Regional Planning Agencies Briefing	January 19, 2023
Town of Bourne Briefing	February 23, 2023
State and Federal Delegation Briefing	March 9, 2023
Regional Transit Authorities Briefing	March 13, 2023
Chambers of Commerce Briefing	March 14, 2023
Cape Cod Commission Briefing	March 15, 2023
Bourne Board of Selectmen Meeting	March 21, 2023

### 9.4.3 Program Contacts

MassDOT has developed a stakeholder database to disseminate Program information throughout Program development. The Program database drew from the Cape Cod Canal Transportation Study and MRER/EA stakeholder lists. Messaging to the database includes schedule updates, public meeting invites and reminders, Program milestones, and public engagement opportunities.

The Program database has grown since the initial launch of meetings, as stakeholders subscribe to updates, submit comments, and attend virtual or in-person meetings. The database is being managed and updated on a regular basis through MassDOT's Public Involvement Management Application (PIMA). The Program database consists of 4,000 stakeholders (as of April 17, 2023), which include, but are not limited to the following:

- Local, State, and Congressional Officials
- Abutters
- Residents and local property owners
- Businesses
- Environmental agencies
- Planning Commissions
- Chambers of Commerce
- Neighborhood associations
- Transit authorities
- Transportation groups
- Community/advocacy groups
- Bike and pedestrian groups
- Tourism sites/groups
- Hospitality groups
- Emergency services
- Education institutions
- Recreation areas
- Tribal councils
- Council on Aging
- Senior Centers
- Members of the public

The Program has established ongoing communication with organizations that identify as serving specific populations as follows:

- Appalachian Mountain Club
- Browning the GreenSpace
- Chappaquiddick Tribe of the Wampanoag Nation
- Chappaquiddick Tribe of the Wampanoag Nation, Whale Clan
- Chaubunagungamaug Nipmuck Indian Council
- Clean Water Action
- Community Action Works
- Conservation Law Foundation
- E4TheFuture
- Environment Massachusetts
- Environmental League of MA
- Healthcare without Harm
- Herring Pond Wampanoag Tribe
- Mass Audubon
- Mass Climate Action Network (MCAN)
- Mass Land Trust Coalition
- Mass Rivers Alliance
- Massachusetts Commission on Indian Affairs (MCIA)
- Neighbor to Neighbor
- Nipmuc Nation (Hassanamisco Nipmucs)

- North American Indian Center of Boston
- Ocean River Institute
- Sierra Club MA
- The Trust for Public Land
- Unitarian Universalist Mass Action Network
- Wampanoag Tribe of Gay Head (Aquinnah)

Communications are distributed regularly to the stakeholder database regarding key milestones such as public meetings, as well as Program information.

## 9.5 Next Steps

Throughout Program development, MassDOT will incorporate measures to avoid and minimize impacts to community and protected resources. MassDOT will continue to execute robust public involvement efforts through the Program PIP. If localized populations meeting the criteria for EJ designation are determined during community engagement efforts, MassDOT will revise the PIP and identify strategies to determine community impacts and develop appropriate mitigation measures.

# Attachment 2 ENF Distribution List

# Cape Cod Bridges Program ENF Distribution List

Cape Cod Bridges Program ENF Distribution List	
State	
<p><b>Massachusetts Environmental Policy Act (MEPA) Office</b>            100 Cambridge Street, Suite 900            Boston, MA 02114  <a href="mailto:MEPA@mass.gov">MEPA@mass.gov</a></p>	<p><b>MEPA Office</b>            Attn: EEA EJ Director            100 Cambridge Street, Suite 900            Boston, MA 02144  <a href="mailto:MEPA-EJ@mass.gov">MEPA-EJ@mass.gov</a></p>
<p><b>Massachusetts Department of Environmental Protection (MassDEP) Southeastern Regional Office</b>            Attn: MEPA Coordinator            20 Riverside Drive            Lakeville, MA 02347  <a href="mailto:George.Zoto@mass.gov">George.Zoto@mass.gov</a>  <a href="mailto:Jonathan.Hobill@mass.gov">Jonathan.Hobill@mass.gov</a></p>	<p><b>MassDEP - Boston Office Commissioner's Office</b>            One Winter Street            Boston, MA 02018  <a href="mailto:Helena.boccadoro@mass.gov">Helena.boccadoro@mass.gov</a></p>
<p><b>Massachusetts Department of Transportation (MassDOT) Public/Private Development Unit</b>            10 Park Plaza, Suite #4150            Boston, MA 02116  <a href="mailto:MassDOTPPDU@dot.state.ma.us">MassDOTPPDU@dot.state.ma.us</a></p>	<p><b>MassDOT - District #5</b>            Attn: MEPA Coordinator            1000 County Street            Taunton, MA 02780  <a href="mailto:Cindy.McConarty@dot.state.ma">Cindy.McConarty@dot.state.ma</a></p>
<p><b>The Massachusetts Historical Commission</b>            The MA Archives Building            220 Morrissey Boulevard            Boston, MA 02125  <a href="mailto:mhc@sec.state.ma.us">mhc@sec.state.ma.us</a>            [BY MAIL]</p>	<p><b>Massachusetts Natural Heritage and Endangered Species Program Division of Fisheries and Wildlife</b>            1 Rabbit Hill Road            Westborough, MA 01581  <a href="mailto:Melany.cheeseman@mass.gov">Melany.cheeseman@mass.gov</a>  <a href="mailto:Emily.holt@mass.gov">Emily.holt@mass.gov</a></p>
<p><b>Massachusetts Division of Marine Fisheries - South Shore</b>            Attn: Environmental Reviewer            836 South Rodney French Boulevard            New Bedford, MA 02744  <a href="mailto:DMF.EnvReview-South@mass.gov">DMF.EnvReview-South@mass.gov</a></p>	<p><b>Coastal Zone Management</b>            Attn: Project Review Coordinator            251 Causeway Street, Suite 800            Boston, MA 02108  <a href="mailto:Robert.Boeri@mass.gov">Robert.Boeri@mass.gov</a>  <a href="mailto:Patrice.bordonaro@mass.gov">Patrice.bordonaro@mass.gov</a></p>



<p><b>Massachusetts Department of Public Health</b>  Attn: Director of Environmental Health  250 Washington Street  Boston, MA 02108  <a href="mailto:DPHToxicology@massmail.state.ma.us">DPHToxicology@massmail.state.ma.us</a></p>	<p><b>Massachusetts Commission on Indian Affairs</b>  John Peters, Executive Director  <a href="mailto:john.peters@mass.gov">john.peters@mass.gov</a></p>
<p><b>Massachusetts Department of Conservation and Recreation</b>  Attn: MEPA Coordinator  251 Causeway Street, Suite 600  Boston, MA 02108  <a href="mailto:andy.backman@mass.gov">andy.backman@mass.gov</a></p>	
<b>Tribal Organizations</b>	
<p><b>Herring Pond Wampanoag Tribe</b>  Melissa Harding-Ferretti, Chair  128 Herring Pond Road  Plymouth, MA, 02360  <a href="mailto:melissa@herringpondtribe.org">melissa@herringpondtribe.org</a></p>	<p><b>Nipmuc Nation (Hassanamisco Nipmucs)</b>  Cheryll Toney Holley, Chair  <a href="mailto:crwritings@aol.com">crwritings@aol.com</a></p>
<p><b>Wampanoag Tribe of Gay Head (Aquinnah)</b>  Bettina Washington, Tribal Historic Preservation Officer  <a href="mailto:thpo@wampanoagtribe-nsn.gov">thpo@wampanoagtribe-nsn.gov</a></p>	<p><b>Chappaquiddick Tribe of the Wampanoag Nation</b>  Alma Gordon, President  <a href="mailto:tribalcouncil@chappaquiddick-wampanoag.org">tribalcouncil@chappaquiddick-wampanoag.org</a></p>
<p><b>Chaubunagungamaug Nipmuck Indian Council</b>  Kenneth White, Council Chairman  <a href="mailto:acw1213@verizon.net">acw1213@verizon.net</a></p>	<p><b>Mashpee Wampanoag Tribe</b>  Brian Weeden, Chair  <a href="mailto:Brian.weeden@mwtribe-nsn.gov">Brian.weeden@mwtribe-nsn.gov</a></p>
<b>Regional Planning Agencies</b>	
<p><b>Cape Cod Commission (CCC)</b>  <a href="mailto:Ksenatori@capecodcommission.org">Ksenatori@capecodcommission.org</a>  <a href="mailto:regulatory@capecodcommission.org">regulatory@capecodcommission.org</a></p>	<p><b>Martha's Vineyard Comission (MVC)</b>  <a href="mailto:turner@mvcommission.org">turner@mvcommission.org</a>  <a href="mailto:morrison@mvcommission.org">morrison@mvcommission.org</a></p>
<p><b>Nantucket Planning and Economic Development Commission (NPEDC)</b>  <a href="mailto:avorce@nantucket-ma.gov">avorce@nantucket-ma.gov</a></p>	<p><b>Southeastern Regional Planning and Economic Development District (SRPEDD)</b>  <a href="mailto:jwalker@srpedd.org">jwalker@srpedd.org</a>  <a href="mailto:gking@srpedd.org">gking@srpedd.org</a>  <a href="mailto:hincavage@srpedd.org">hincavage@srpedd.org</a>  <a href="mailto:bnap@srpedd.org">bnap@srpedd.org</a></p>
<p><b>Old Colony Planning Council</b>  <a href="mailto:mwaldron@ocpcrpa.org">mwaldron@ocpcrpa.org</a>  <a href="mailto:kmowatt@ocpcrpa.org">kmowatt@ocpcrpa.org</a>  <a href="mailto:ckilmer@ocpcrpa.org">ckilmer@ocpcrpa.org</a></p>	

## Environmental Justice Community Based Organizations

<p><b>Unitarian Universalist Mass Action Network</b> Tali Smookler, Organizing Director <a href="mailto:tsmookler@umassaction.org">tsmookler@umassaction.org</a></p>	<p><b>Appalachian Mountain Club</b> Heather Clish, Director of Conservation and Recreation Policy <a href="mailto:hclish@outdoors.org">hclish@outdoors.org</a></p>
<p><b>Browning the GreenSpace</b> Kerry Bowie, Board President <a href="mailto:Kerry@msaadapartners.com">Kerry@msaadapartners.com</a></p>	<p><b>Mass Audubon</b> Heidi Ricci, Director of Policy 208 South Great Road Lincoln, MA 01773 <a href="mailto:hricci@massaudubon.org">hricci@massaudubon.org</a></p>
<p><b>Clean Water Action</b> Cindy Luppi, New England Director 88 Broad Street, Lower Level Boston, MA 02118 <a href="mailto:cluppi@cleanwater.org">cluppi@cleanwater.org</a></p>	<p><b>Mass Climate Action Network (MCAN)</b> Sarah Dooling, Executive Director <a href="mailto:Sarah@massclimateaction.net">Sarah@massclimateaction.net</a></p>
<p><b>Community Action Works</b> Sylvia Broude, Executive Director 294 Washington Street #500 Boston, MA, 02108 <a href="mailto:sylvia@communityactionworks.org">sylvia@communityactionworks.org</a></p>	<p><b>Conservation Law Foundation</b> Stacy Rubin, Senior Attorney 62 Summer Street Boston, MA, 02110 <a href="mailto:srubin@clf.org">srubin@clf.org</a></p>
<p><b>E4TheFuture</b> Pat Stanton, Project Manager 205 Newbury Street Framingham, MA 01707 <a href="mailto:pstanton@e4thefuture.org">pstanton@e4thefuture.org</a></p>	<p><b>Environment Massachusetts</b> Ben Hellerstein, MA State Director 292 Washington St., Suite 500 Boston, MA 02108 <a href="mailto:ben@environmentmassachusetts.org">ben@environmentmassachusetts.org</a></p>
<p><b>Environmental League of Massachusetts</b> Nancy Goodman, Vice President for Policy 15 Court Square, Suite 1000 Boston, MA 02108 <a href="mailto:ngoodman@environmentalleague.org">ngoodman@environmentalleague.org</a></p>	<p><b>Healthcare Without Harm</b> Tim Cronin, MA Director of Climate Policy 12110 Sunset Hills Road Suite 600 Reston, VA, 20190 <a href="mailto:tcronin@hcwh.org">tcronin@hcwh.org</a></p>
<p><b>Mass Land Trust Coalition</b> Robb Johnson, Executive Director <a href="mailto:robb@massland.org">robb@massland.org</a></p>	<p><b>Mass Rivers Alliance</b> Julia Blatt, Executive Director <a href="mailto:Juliablatt@massriversalliance.org">Juliablatt@massriversalliance.org</a></p>
<p><b>Neighbor to Neighbor</b> Elvis Mendez, Organizing Director <a href="mailto:elvis@n2nma.org">elvis@n2nma.org</a></p>	<p><b>North American Institute Center of Boston</b> Raquel Halsey, Executive Director <a href="mailto:rhalsey@naicob.org">rhalsey@naicob.org</a></p>
<p><b>Ocean River Institute</b> Rob Moir, Executive Director <a href="mailto:rob@oceanriver.org">rob@oceanriver.org</a></p>	<p><b>Sierra Club MA,</b> Deb Pasternak, Director of the MA Chapter <a href="mailto:debpasternak@sierraclub.org">debpasternak@sierraclub.org</a></p>

<b>The Trust for Public Land</b> Kelly Boling, MA & RI State Director <a href="mailto:Kelly.boling@tpl.org">Kelly.boling@tpl.org</a>	<b>Community Action Committee of Cape Cod &amp; Islands</b> Kristina Dower, Executive Director <a href="mailto:info@cacci.cc">info@cacci.cc</a>
<b>Cape Cod Climate Action Collaborative</b> Barry Margolin, Chair, Policy & Program Committee <a href="mailto:info@capecodclimate.org">info@capecodclimate.org</a>	<b>Groundwork South Coast</b> Maura Valdez, Executive Director <a href="mailto:MValdez@groundworksouthcoast.org">MValdez@groundworksouthcoast.org</a>
<b>Town of Bourne</b>	
<b>Town of Bourne Planning Board</b> Jennifer Copeland, Town Planner 24 Perry Ave, Room 201 Buzzard Bay, MA 02532 <a href="mailto:jcopeland@townofbourne.com">jcopeland@townofbourne.com</a>	<b>Town of Bourne Board of Health</b> Terry Guarino, Health Agent 24 Perry Ave, Room 201 Buzzards Bay, MA 02532 <a href="mailto:sburgess@townofbourne.com">sburgess@townofbourne.com</a> <a href="mailto:tguarino@townofbourne.com">tguarino@townofbourne.com</a> <a href="mailto:duitti@townofbourne.com">duitti@townofbourne.com</a>
<b>Town of Bourne Board of Selectmen</b> Peter Meier, Chairman 24 Perry Ave, Room 101 Buzzard Bay, MA 02532 <a href="mailto:pmeier@townofbourne.com">pmeier@townofbourne.com</a>	<b>Town of Bourne Conservation Commission</b> Robert Gray, Chairperson 24 Perry Ave, Room 201 Buzzards Bay, MA 02532 <a href="mailto:rgray@townofbourne.com">rgray@townofbourne.com</a>
<b>Town of Sandwich</b>	
<b>Town of Sandwich Planning Board</b> Ralph Vitacco, Director of Planning and Economic Development <a href="mailto:rvitacco@sandwichmass.org">rvitacco@sandwichmass.org</a>	<b>Town of Sandwich Board of Selectmen</b> Shane Hctor, Chairman <a href="mailto:shoctor@sandwichmass.org">shoctor@sandwichmass.org</a>
<b>Town of Sandwich Conservation Commission</b> David DeConto, Chairperson <a href="mailto:ddeconto@sandwichmass.org">ddeconto@sandwichmass.org</a>	<b>Town of Sandwich Health Department</b> Darren Meyer, Assistant Director of Health <a href="mailto:dmeyer@sandwichmass.org">dmeyer@sandwichmass.org</a>

# Attachment 3 List of Anticipated Approvals and Permits

## Cape Cod Bridges Program - List of Anticipated Approvals and Permits

Authority	Regulation	Permit/Regulatory Approval
<b>Federal</b>		
<b>Federal Highway Administration (FHWA)</b>	National Environmental Policy Act (NEPA)	NEPA Decision
<b>FHWA, Official(s) with Jurisdiction</b>	Section 4(f) of the United States Department of Transportation Act	Section 4(f) Approval
<b>Federal Aviation Administration</b>	29 USC 44718 and 14 CFR 77	Notice of Construction/ Determination of No Hazard to Air Navigation
<b>U.S. Army Corps of Engineers (USACE)</b>	Section 404 of the Clean Water Act; Section 10 of the Rivers and Harbors Act	Section 404/10 Permit
	Section 14 of the Rivers and Harbors Act	Section 408 Permission to Alter a USACE Civil Works Project
	43 CFR 7.00; Protection of Archaeological Resources	Federal Archaeologist Permit
<b>U.S. Coast Guard</b>	Section 9 of the Rivers and Harbors Appropriations Act	U.S. Coast Guard Section 9 Bridge Permit
<b>U.S. Fish and Wildlife Service</b>	Section 7 of the Endangered Species Act	Section 7 Consultation
	Migratory Bird Treaty Act	Review
	Bald and Golden Eagle Protection Act	Review
	Fish and Wildlife Coordination Act	Review

Authority	Regulation	Permit/Regulatory Approval
National Marine Fisheries Service, Greater Atlantic Regional Fisheries Office	Magnuson-Stevens Fishery Conservation and Management Act	Essential Fish Habitat Consultation/ Assessment
	Marine Mammal Protection Act of 1972	Review
	Section 7 of the Endangered Species Act	Section 7 Consultation
U.S. Environmental Protection Agency (EPA)	National Pollution Discharge Elimination System (NPDES)	Construction Stormwater General Permit
EPA and Massachusetts Department of Environmental Protection (MassDEP)		Massachusetts Small Municipal Separate Storm Sewer Systems (MS4) Permit
FHWA, Massachusetts Department of Transportation (MassDOT) and Massachusetts State Historic Preservation Officer (MA SHPO)	Section 106 of the National Historic Preservation Act	Memorandum of Agreement
FHWA, USACE, MassDOT, and MASHPO		Amended Programmatic Agreement
<b>State</b>		
Massachusetts Executive Office of Energy and Environmental Affairs	Massachusetts Environmental Policy Act (MEPA); 301 CMR 11.00	Secretary's Certificate
Massachusetts Historical Commission	950 CMR 70.00 Massachusetts State Historical Commission	State Archaeologist Permit
Massachusetts Office of Coastal Zone Management	Coastal Zone Management Act (CZM); 301 CMR 21.00	CZM Federal Consistency Review
MassDEP	Section 401 of the U.S. Clean Water Act	Section 401 Water Quality Certificate

Authority	Regulation	Permit/Regulatory Approval
	Massachusetts Public Waterfront Act, Chapter 91; 310 CMR 9.00	Chapter 91 Waterways License
<b>Massachusetts Division of Fisheries and Wildlife</b>	Massachusetts Endangered Species Act (MESA); 321 CMR 10	MESA Conservation & Management Permit (to be determined)
<b>Local</b>		
<b>Bourne Conservation Commission</b>	Massachusetts Wetlands Protection Act (MA WPA); 310 CMR 10	Order of Conditions

# Attachment 4 Alternatives Analysis Report



## Table Of Contents

<b>Executive Summary</b> .....	<b>1</b>
<b>U.S. Army Corps of Engineers Major Rehabilitation Evaluation Report/Environmental Assessment - Cape Cod Canal Highway Bridges</b> .....	<b>4</b>
<b>1 Introduction</b> .....	<b>4</b>
<b>2 Identification and Screening of Initial Alternatives</b> .....	<b>5</b>
2.1 Base Condition – Alternative A.....	7
2.2 Major Rehabilitation of Both Bridges – Alternative B .....	8
2.3 Replacement of One or Both Highway Bridges with New Bridges Limited to Four Lanes Each – Alternative C .....	8
2.4 Replacement of One or Both Highway Bridges with New Bridges with Four Through-Traffic Lanes and Two Auxiliary Lanes – Alternative D.....	9
2.5 Replacement of One or Both Highway Bridges with New Bridges with Additional (More than Four) Non-Federally Funded Through Traffic Lanes, plus Two Auxiliary Lanes – Alternative E.....	9
2.6 Replacement of Both Highway Bridges with a Single New Bridge – Alternative F .....	10
2.7 Construction of a Third Highway Bridge– Alternative G .....	10
2.8 Replacement of One or Both Highway Bridges with a Single Tunnel or Tunnels – Alternative H.....	10
2.9 Replacement of Both Bridges with a Single Tunnel – Alternative I .....	11
2.10 Replacement of One or Both Bridges with Low-Level Draw Spans – Alternative J.....	11
2.11 Replacement of Both Bridges with Low-Level Causeways – Alternative K .....	12
2.12 Deauthorization and Closure of Cape Cod Canal – Alternative L.....	12
<b>3 Detailed Alternatives Evaluation</b> .....	<b>12</b>
3.1 Alternative A – Base Condition .....	14
3.2 Alternative B – Major Rehabilitation .....	14
3.3 Alternative D – Bridge Replacement with Six Lanes.....	15
<b>4 MRER/EA Highways Bridges Preferred Alternative</b> .....	<b>16</b>
<b>Massachusetts Department of Transportation Cape Cod Bridges Program Phase 1 and Phase 2 Assessments</b> .	<b>18</b>
<b>1 Introduction</b> .....	<b>18</b>
1.1 Cape Cod Bridges Program Study Area.....	18
1.2 Program Purpose and Need .....	21
1.2.1 Program Purpose .....	21
1.2.2 Program Needs .....	21
1.3 MassDOT’s Alternatives Assessment Process.....	21
<b>2 Phase 1 Bridge Highway Assessments</b> .....	<b>22</b>

2.1	Bridge Highway Cross-Section .....	22
2.2	Shared Use Path .....	23
3	<b>Phase 1 Bridge Assessment: Vertical and Horizontal Clearances</b> .....	24
3.1	Bridge Vertical Clearance .....	24
3.2	Bridge Horizontal Clearance .....	24
4	<b>Phase 1 Bridge Assessment: Main Span Length and Bridge Pier Location</b> .....	25
4.1	Main Span Length and Pier Location Options .....	25
4.2	Main Span and Bridge Pier Screening Methodology .....	25
4.3	Main Span and Bridge Pier Screening Results.....	25
4.3.1	Option Advanced for Further Evaluation: Out-of-Water Piers .....	26
4.3.2	Option Dismissed from Further Evaluation: In-Water Piers .....	28
5	<b>Phase 1 Bridge Assessment: Bridge Deck Configuration</b> .....	29
6	<b>Phase 1 Bridge Assessment: Bridge Types</b> .....	31
6.1	Bridge Type Selection.....	31
6.1.1	Truss Bridge .....	32
6.1.2	Tied-Arch Bridge .....	33
6.1.3	Cable-Stayed Bridge .....	33
6.1.4	Box Girder Bridge .....	34
6.2	Bridge Type Screening Methodology .....	35
6.3	Bridge Type Phase 1 Screening Results .....	36
6.3.1	Bridge Type Options Advanced for Further Evaluation .....	38
6.3.2	Bridge Type Options Dismissed from Further Evaluation.....	40
7	<b>Phase 2 Bridge Assessment: Bridge Type Secondary Screening</b> .....	41
7.1	Highway Geometrics Assessments.....	42
7.2	Constructability Assessments .....	42
7.2.1	Bridge Deck Configuration.....	42
7.2.2	Bridge Fabrication and Erection Methodologies .....	43
7.3	Public Review of Preliminary Recommendations .....	44
7.3.1	Community Considerations and Bridge Aesthetics .....	44
7.3.2	Public Polling Results .....	50
7.4	Bridge Type Phase 2 Screening Results .....	51
8	<b>Mainline Alignment Location Assessment</b> .....	53
8.1	Mainline Alignment Location Options.....	53
8.2	Mainline Alignment Screening Methodology .....	53
8.3	Bourne Bridge Mainline Alignment Location Screening Results .....	54
8.3.1	Option Advanced for Further Evaluation: Fully Offline Inboard.....	56
8.3.2	Options Dismissed from Further Evaluation.....	57

8.4	<b>Sagamore Bridge Mainline Alignment Location Screening Results .....</b>	<b>62</b>
8.4.1	Option Advanced for Further Evaluation: Fully Offline Inboard .....	64
8.4.2	Options Dismissed from Further Evaluation.....	65
<b>9</b>	<b><i>Phase 1 Highway Interchange Approach Assessments.....</i></b>	<b>71</b>
9.1	<b>Initial Investigations .....</b>	<b>73</b>
9.2	<b>Interchange Approach Conceptual Screening Methodology .....</b>	<b>73</b>
9.3	<b>Bourne North Crossing Interchange Approach Screening Results.....</b>	<b>75</b>
9.3.1	Options Advanced for Further Evaluation .....	75
9.3.2	Option Dismissed from Further Evaluation: Option BN-10 .....	85
9.4	<b>Bourne South Crossing Interchange Approach Screening Results.....</b>	<b>88</b>
9.4.1	Options Advanced for Further Evaluation .....	89
9.4.2	Options Dismissed for Further Evaluation.....	94
9.5	<b>Sagamore North Crossing Interchange Approach Screening Results.....</b>	<b>103</b>
9.5.1	Options Advanced for Further Evaluation .....	104
9.5.2	Options dismissed from Further Evaluation .....	110
9.6	<b>Sagamore South Crossing Interchange Approach Screening Results.....</b>	<b>116</b>
9.6.1	Options Advanced for Further Evaluation .....	116
9.6.2	Options Dismissed from Further Evaluation.....	126
9.7	<b>Summary of Phase 1 Interchange Approach Assessments .....</b>	<b>144</b>
<b>10</b>	<b><i>Conclusions and Next Steps.....</i></b>	<b>145</b>
<b>Appendix A</b>	<b><i>Cape Cod Bridge Replacements Initial Screening Report.....</i></b>	<b>148</b>
<b>Appendix B</b>	<b><i>Cape Cod Bridge Replacements Constructability Assessment.....</i></b>	<b>149</b>
<b>Appendix C</b>	<b><i>Cape Cod Bridges Replacements Phase II Screening Report.....</i></b>	<b>150</b>
<b>Appendix D</b>	<b><i>Cape Cod Bridges Program Interchange Approach Concepts.....</i></b>	<b>151</b>

## Figures

<b>Figure ES-1</b>	<b><i>Bourne and Sagamore Bridges Location Map.....</i></b>	<b>2</b>
<b>Figure 4-1</b>	<b><i>MRER/EA Preferred Alternative: Conceptual Bridge Replacement .....</i></b>	<b>17</b>
<b>Figure 1-1</b>	<b><i>Cape Cod Bridges Program - Bourne Program Study Area.....</i></b>	<b>19</b>
<b>Figure 1-2</b>	<b><i>Cape Cod Bridges Program – Sagamore Program Study Area .....</i></b>	<b>20</b>
<b>Figure 2-1</b>	<b><i>Replacement Bridge Highway Cross-Section .....</i></b>	<b>24</b>
<b>Figure 4-1</b>	<b><i>Main Span and Pier Location Out-of-Water Option – Approximate 700-Foot Span Length.....</i></b>	<b>26</b>
<b>Figure 4-2</b>	<b><i>Main Span Out-of-Water Option – Approximate 820-Foot Span Length .....</i></b>	<b>27</b>
<b>Figure 4-3</b>	<b><i>Main Span In-Water Option – Approximate 525-Foot Span .....</i></b>	<b>28</b>
<b>Figure 4-4</b>	<b><i>Main Span In-Water Option –Approximate 616-Foot Span Length.....</i></b>	<b>29</b>

<i>Figure 5-1. Bridge Structure Configuration with a Single Deck</i> .....	30
<i>Figure 5-2. Bridge Structure Configuration with Separate Decks</i> .....	30
<i>Figure 6-1. Bridge Type by Cost and Span Length</i> .....	32
<i>Figure 6-2. Schematic of Truss Bridge Option</i> .....	32
<i>Figure 6-3. Schematic of Tied-Arch Bridge Option – Longer Arch (Non-Delta Frame)</i> .....	33
<i>Figure 6-4. Schematic Of Tied-Arch Bridge Option – Delta Frame</i> .....	33
<i>Figure 6-5. Schematic of Cable-Stayed Bridge Option – Single-Tower</i> .....	34
<i>Figure 6-6. Schematic of Cable-Stayed Bridge Option – Two-Towers</i> .....	34
<i>Figure 6-7. Schematic of Concrete Box Girder Bridge Option</i> .....	34
<i>Figure 7-1. Rendering of Existing Bridge – Cape Cod Canal Viewpoint</i> .....	45
<i>Figure 7-2. Rendering of Existing Bridge – Driver Viewpoint</i> .....	46
<i>Figure 7-3. Rendering of Tied Arch Bridge with Delta Frame – Cape Cod Canal Viewpoint</i> .....	47
<i>Figure 7-4. Rendering of Tied Arch Bridge with Delta Frame – Driver Viewpoint</i> .....	47
<i>Figure 7-5. Rendering of Two-Tower Cable Stayed Bridge – Cape Cod Canal Viewpoint</i> .....	48
<i>Figure 7-6. Rendering Of Two-Tower Cable Stayed Bridge – Driver Viewpoint</i> .....	49
<i>Figure 7-7. Rendering of Concrete Box Girder Bridge – Cape Cod Canal Viewpoint</i> .....	50
<i>Figure 7-8. Rendering Of Concrete Box Girder Bridge – Driver Viewpoint</i> .....	50
<i>Figure 8-1. Bourne Bridge Fully Offline Inboard Option</i> .....	56
<i>Figure 8-2. Bourne Bridge Partially Offline Inboard Option</i> .....	57
<i>Figure 8-3. Bourne Bridge Partially Offline Outboard Option</i> .....	59
<i>Figure 8-4. Bourne Bridge Fully Offline Outboard Option</i> .....	60
<i>Figure 8-5. Bourne Bridge Split Option</i> .....	61
<i>Figure 8-6. Sagamore Bridge Fully Offline Inboard Option</i> .....	64
<i>Figure 8-7. Sagamore Bridge Partially Offline Inboard Option</i> .....	65
<i>Figure 8-8. Sagamore Bridge Partially Offline Outboard Option</i> .....	67
<i>Figure 7-9. Sagamore Bridge Fully Offline Outboard Option</i> .....	68
<i>Figure 8-10. Sagamore Bridge Split Open</i> .....	70
<i>Figure 9-1. Bourne and Sagamore Program Study Area Quadrants</i> .....	72
<i>Figure 9-2. Bourne North Crossing Interchange Approach Option BN-6.1</i> .....	77
<i>Figure 9-3. Bourne North Crossing Interchange Approach Option BN-13.1</i> .....	80
<i>Figure 9-4. Bourne North Crossing Interchange Approach Option BN-14.4b</i> .....	83
<i>Figure 9-5. Bourne North Crossing Interchange Approach Option BN-10</i> .....	86

<i>Figure 9-6. Bourne South Crossing Interchange Approach Option BS-2.....</i>	<i>90</i>
<i>Figure 9-7. Bourne South Crossing Interchange Approach Option BS-2.2.....</i>	<i>92</i>
<i>Figure 9-8. Bourne South Crossing Interchange Approach Option BS-6.1.....</i>	<i>95</i>
<i>Figure 9-9 Bourne South Crossing Interchange Approach Option BS-9.....</i>	<i>98</i>
<i>Figure 9-10. Bourne South Crossing Interchange Approach Option BS-9.1.....</i>	<i>101</i>
<i>Figure 9-11. Sagamore North Crossing Interchange Approach Option SN-1A.....</i>	<i>105</i>
<i>Figure 9-12. Sagamore North Crossing Interchange Approach Option SN-8A.....</i>	<i>108</i>
<i>Figure 9-13. Sagamore North Crossing Interchange Approach Option SN-3A.....</i>	<i>111</i>
<i>Figure 9-14. Sagamore North Crossing Interchange Approach Option SN-4A.....</i>	<i>114</i>
<i>Figure 9-15. Sagamore South Crossing Interchange Approach Option SS-1.....</i>	<i>118</i>
<i>Figure 9-16. Sagamore South Crossing Interchange Approach Option SS-1.1.....</i>	<i>121</i>
<i>Figure 9-17. Sagamore South Crossing Interchange Approach Option SS-3.1A.....</i>	<i>124</i>
<i>Figure 9-18. Sagamore South Crossing Interchange Approach Option SS-3.....</i>	<i>127</i>
<i>Figure 9-19. Sagamore South Crossing Interchange Approach Option SS-3.1.....</i>	<i>130</i>
<i>Figure 9-20. Sagamore South Crossing Interchange Approach Option SS-3.2.....</i>	<i>133</i>
<i>Figure 9-21Sagamore South Crossing Interchange Approach Option SS-9 .....</i>	<i>136</i>
<i>Figure 9-22. Sagamore South Crossing Interchange Approach Option SS-9.1.....</i>	<i>139</i>
<i>Figure 9-23. Sagamore South Crossing Interchange Approach Option SS-9.1A.....</i>	<i>142</i>

## Tables

<i>Table 2-1 Screening of Initial Alternatives.....</i>	<i>6</i>
<i>Table 3-1. Alternatives Advanced for Detailed Analysis.....</i>	<i>13</i>
<i>Table 4-1. Summary of Main Span Length and Bridge Pier Location Options.....</i>	<i>26</i>
<i>Table 6-1. Summary of Bridge Phase 1 Screening – 700-Foot Main Span.....</i>	<i>36</i>
<i>Table 6-2. Summary of Bridge Phase 1 Screening – 820-Foot Main Span.....</i>	<i>37</i>
<i>Table 7-1. Public Review: Bridge Replacement Considerations.....</i>	<i>51</i>
<i>Table 7-2. Public Review: Bridge Type Options.....</i>	<i>51</i>
<i>Table 7-3. Summary of Bridge Phase 2 Screening – 700-Foot Mainline Span Length .....</i>	<i>52</i>
<i>Table 7-4. Summary Of Bridge Phase 2 Screening – 820-Foot Mainline Span Length.....</i>	<i>52</i>
<i>Table 8-1. Screening Results of Bourne Bridge Mainline Alignment Location Options.....</i>	<i>55</i>
<i>Table 8-2. Screening Results of Sagamore Bridge Mainline Alignment Location Options .....</i>	<i>62</i>
<i>Table 9.1. Screening Results of Bourne North Crossing Interchange Approach Options.....</i>	<i>75</i>

**Table 9-2. Screening Results of Bourne South Crossing Interchange Approach Options..... 88**  
**Table 9-3. Screening Results of Sagamore North Crossing Interchange Approach Options ..... 104**  
**Table 9-4. Screening Results of Sagamore South Crossing Interchange Approach Options ..... 116**  
**Table 9-5. Bourne and Sagamore Crossing Interchange Approach Alternatives for Further Screening ..... 144**  
**Table 10-1. Summary of Cape Cod Bridges Program Design Parameters ..... 145**

# Executive Summary

The Bourne and Sagamore highway bridges span Cape Cod Canal, located in the town of Bourne, Barnstable County, Massachusetts (Figure ES-1). As part of the Cape Cod Federal Navigation Project (FNP), the bridges are federally owned and managed by the New England District of the U.S. Army Corps of Engineers (USACE).

The current bridges were constructed beginning in 1933 and opened to traffic in 1935. At nearly 90 years old, the Bourne and Sagamore bridges are in deteriorated condition and are determined to be functionally obsolete.<sup>1</sup> Both highway bridge crossings over Cape Cod Canal are vital components of the local and regional transportation network, as they provide the only vehicular access on and off Cape Cod for the 230,000 year-round residents of Barnstable County, and millions of visitors to the Cape each year during the height of the summer tourist season from Memorial Day through Labor Day. The bridges and their approach roadway network no longer meet the needs of the traveling public. The combination of today's high traffic volumes and substandard design features of the Bourne and Sagamore bridges and their approach roadway network substantially impairs traffic operations and safety within vicinity of the Cape Cod Canal.

The Alternatives Analysis Report for the Cape Cod Bridges Program presents the results of two major development phases of a multi-agency examination of the best means to address the functionally obsolete Bourne and Sagamore highway bridges and their operationally deficient highway approach networks.

Phase One of the Alternatives Analysis consists of the U.S. Army Corps of Engineers' (USACE's) Major Rehabilitation Evaluation (MRE) of the Bourne and Sagamore bridges. The MRE, which was initiated in the fall of 2018, examined the relative merits of rehabilitating or replacing the two high-level highway bridges. The USACE's analysis included an Environmental Assessment (EA) pursuant to the National Environmental Policy Act (NEPA). The USACE acknowledged that its MRE Report (MRER) and its accompanying NEPA document were the first phase in examining the future of the Cape Cod Canal Highway Bridges. The purpose of the Phase One evaluation was to examine whether standard operation and maintenance, a program of repair and major rehabilitation, or replacement of one or both bridges, would provide the most reliable fiscally responsible solution. The MRER investigated the problem, developed and evaluated potential alternatives, screened out less practicable alternatives, and

---

<sup>1</sup> TranSystems Corporation, Routine Inspection Report, Volume I of III; 2020 Routine Inspection of the Bourne Bridge over the Cape Cod Canal, February 2021. TranSystems Corporation, Routine Inspection Report, Volume I of III; 2021 Routine Inspection of the Sagamore Bridge over the Cape Cod Canal, January 2022.

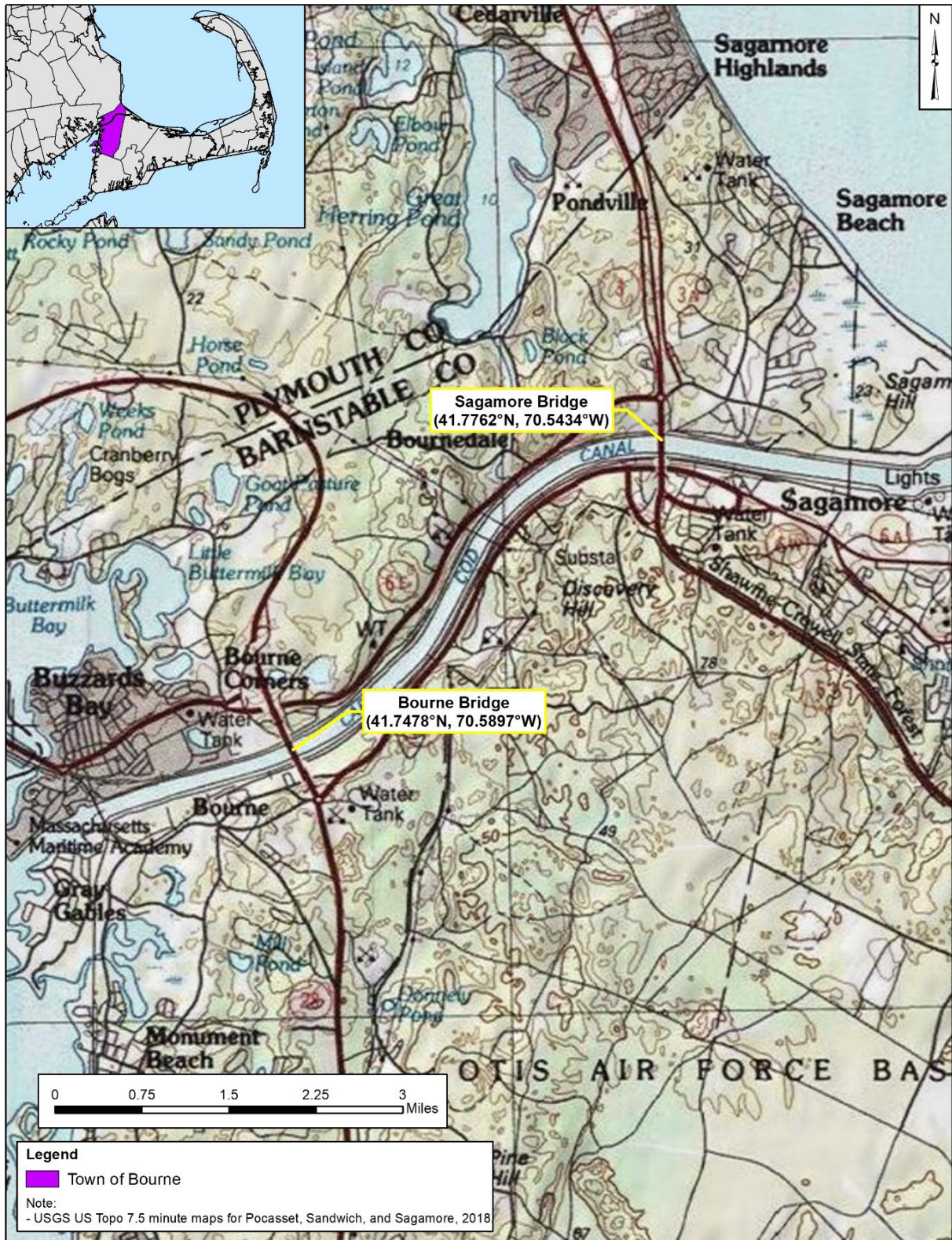


Figure ES-1. Bourne and Sagamore Highway Bridges Location Map



recommended the most cost-effective course of action for meeting future needs. The Federal Highway Administration (FHWA) and the Massachusetts Department of Transportation (MassDOT) were cooperating agencies in the NEPA process. The USACE further acknowledged that the Commonwealth of Massachusetts would be a necessary partner in any rehabilitation or replacement project, indicating that the Commonwealth's principal role would involve redesign and relocation of connecting highways and roadways if bridge replacement is pursued. The MRER and EA resulted in a decision to replace both bridges with new bridges that conform to modern highway design standards. In March 2022, the USACE formally issued a Finding of No Significant Impact (FONSI) for the proposed action to replace the Bourne and Sagamore bridges.

In July 2020 during the preparation of the MRER and EA, a Memorandum of Understanding (MOU) was executed between the USACE and MassDOT regarding the future ownership, operations, and maintenance of the Bourne and Sagamore highway bridges. According to the terms of the agreement, the USACE is responsible for the ownership, operation, and maintenance of the two existing bridges until replacement bridges are built and operational. MassDOT is responsible for leading Program delivery (including the feasibility study, alternatives analysis, preliminary design, and environmental permitting processes), as well as overseeing procurement and construction of the new bridges. MassDOT will then own, operate, and maintain the completed bridges and approaches as part of the system of state highways to be maintained by MassDOT.

Phase Two of the Alternatives Analysis consists of MassDOT's follow-up analysis of the replacement bridges and the highway approach network on both sides of Cape Cod Canal. Utilizing the findings of the USACE's MRER/EA as the foundation for the Cape Cod Bridges Program, MassDOT's subsequent analyses, conducted in coordination with the USACE and FHWA, incorporate the Phase One assessment decision to replace both highway bridges with new bridges with four through-traffic lanes and two auxiliary lanes (In-Kind Bridge Replacement, updated to comply with federal and state highway and design safety standards). MassDOT evaluated, confirmed, and refined the design parameters of the MRER/EA's Preferred Alternative for the Bourne and Sagamore replacement structures through an assessment of the proposed bridge span and pier locations, bridge deck configuration, bridge type, and mainline alignment location. MassDOT also developed and screened initial concepts for the highway interchange approaches at each bridge crossings. Based on a preliminary assessment relative to its highway design evaluation criteria, MassDOT has identified alternatives for the off-Cape and on-Cape highway interchange approach networks at the two bridge crossings. MassDOT is conducting further design and analysis to identify the preferred alternatives for the Bourne and Sagamore bridge highway connections.

# U.S. Army Corps of Engineers Major Rehabilitation Evaluation Report/Environmental Assessment - Cape Cod Canal Highway Bridges

## 1 Introduction

In March 2020, the U.S. Army Corps of Engineers (USACE) completed a multi-year Major Rehabilitation Evaluation (MRE) of the Bourne and Sagamore highway bridges. The USACE is required to complete an MRE whenever infrastructure maintenance construction costs are expected to exceed \$20 million and would take more than two years of construction to complete. The MRE is a four-part evaluation: a structural engineering risk and reliability analysis of the current structures, cost engineering, economic analysis, and environmental evaluation of all feasible alternatives.

The USACE completed the first program of major rehabilitation of both bridges in the early 1980s. Both bridges are now scheduled to undergo their second major rehabilitation. In 2025-2027, the USACE proposes to rehabilitate the Sagamore Bridge, estimated at \$185 million; and in 2029-2031, the USACE proposes to rehabilitate the Bourne Bridge, estimated at \$210 million. The USACE determined that the major rehabilitation would have transportation impacts on- and off-Cape, as well as on Martha's Vineyard, Nantucket, and the Elizabeth Islands (the Islands). The USACE determined that lengthy lane closures and full bridge closures would be necessary during the major rehabilitation efforts. Closures of the canal to marine traffic would also be necessary during some bridge work for the superstructure and deck. These closures would result in costs due to traffic delays, congestion, and re-routing, in addition to the costs of bridge rehabilitation itself. Further, the USACE anticipated that another major rehabilitation of both bridges would occur in the 2065-2069 timeframe.

Given the high cost of major rehabilitation, the impacts expected to result from such actions, and the fact that major rehabilitation would not address the issues with current and anticipated traffic volumes, modern day highway and bridge design standards, and the escalating costs of normal maintenance and repairs, the USACE conducted the MRE to identify and evaluate conceptual alternatives to determine whether major rehabilitation or bridge replacement would provide the most cost effective, safe, efficient, and reliable means of providing long-term vehicular crossings of Cape Cod Canal. The USACE examined bridge performance, benefits, costs, and impacts in the context of continued rehabilitation versus replacement over a 50-year period of analysis, per USACE regulation and policy. The alternatives were measured against a common Base Condition of continued maintenance and repair of the bridges as needed, but without major rehabilitation. In addition to the Base Condition, the USACE identified and screened other alternatives for crossing Cape Cod Canal. The study resulted in publication of the MRE Report (MRER), which evaluated the risk and reliability of the Bourne and Sagamore bridges, as well as the economic impacts and benefits of numerous alternatives.

As part of the MRE process, the USACE completed an Environmental Assessment (MRER/EA) pursuant to the requirements of the National Environmental Policy Act (NEPA).<sup>2</sup> The USACE determined that the purpose of the USACE’s Cape Cod Canal Bourne and Sagamore Bridges Project is *to restore or replace the existing deteriorated bridges to provide structures which will maintain reliability of service, improve safety and ease of maintenance, and provide safe, secure, and cost effective access across the Cape Cod Canal*. The Federal Highway Administration (FHWA) and the Massachusetts Department of Transportation (MassDOT) participated in the MRER/EA as cooperating agencies. With the alternatives developed and assessed at a concept level only, the USACE considered the MRER and the NEPA document to be the first phase in examining the future of the Cape Cod highway bridges.

Based on a detailed evaluation of costs and benefits of all feasible alternatives presented in the MRER/EA, the USACE determined that replacement of both bridges with new bridges that conform to modern highway design standards would be the most cost-effective practicable alternative for providing critical public transportation access across the Cape Cod Canal. This recommendation considered the safety and reliability of the bridges and the Cape Cod Canal for both vehicular and maritime transportation. After the completion of an extended public comment period on the recommendation, the USACE and Assistant Secretary of the Army for Civil Works officially announced their decision to replace the current Sagamore and Bourne bridges with two new bridges built to modern-day standards on April 3, 2020.

Based on the findings of the MRER/EA and receipt of public comments, the USACE determined that the replacement of both highway bridges with new bridges (Preferred Alternative) would not have significant adverse impact on the environment. On March 29, 2022, the USACE formally issued a Finding of No Significant Impact (FONSI) for the proposed action to replace the Bourne and Sagamore bridges.<sup>3</sup>

## 2 Identification and Screening of Initial Alternatives

In addition to the Base Condition (Alternative A), the USACE identified eleven initial alternatives, Alternatives B through L. Per NEPA regulations, federal agencies are required to identify a reasonable range of alternatives that meet the purpose included those that are practical or feasible from a technical and economic standpoint. The USACE reported that many of the initial alternatives presented in the MRER/EA were introduced during a series of five public information sessions held in December 2018 to discuss the future of the bridges.

The initial alternatives were evaluated and screened to reduce the alternatives to those which would be implementable with respect to the following:

---

<sup>2</sup> USACE, New England District. Major Rehabilitation Evaluation Report and Environmental Assessment, Cape Cod Canal Highway Bridges, Bourne, Massachusetts. March 2020.

<sup>3</sup> The MRER/EA and supporting documentation are available via the USACE New England District’s website.

- Functionality (Project Purpose), considering whether the alternative would provide safe, reliable, long-term vehicular access connecting Cape Cod with the mainland;
- Cost, considering whether the alternative could be implemented at a reasonable cost, measured over the USACE’s 50-year period of analysis;
- Impacts, considering whether the alternative could be implemented without significant environmental, social and cultural resource impacts;
- Navigability, considering whether the alternative would allow for continued maritime use of Cape Cod Canal as a safe passage for deep-draft and shallow-draft vessels, consistent with the Congressional authorization for the Cape Cod Canal Federal Navigation Project (FNP);
- Authority, considering whether the alternative would be within the USACE’s existing authorization for the Cape Cod Canal FNP.

Table 2-1 lists the twelve alternatives presented in the MRER/EA and the initial screening results. Alternatives that failed more than one of the screening measures or those alternatives that were not within the USACE’s existing authorization were eliminated from further consideration and were not advanced for further analysis.

Table 2-1 Screening of Initial Alternatives

Initial Alternative	Screening Criteria				
	Retains Functionality	Excessive Cost	Significant Impact	Maintains Navigation	Within USACE Authority
<b>A - Base Condition (No-Action) Alternative. Fix as Fails.</b>	Base Plan/No Action advanced per NEPA requirements.				
B - Major Rehabilitation	Yes	No	Yes	Yes	Yes
C - Replacement - Four Lanes Each	No	No	Yes	Yes	Yes
D – Replacment – Six Lanes Each	Yes	No	No	Yes	Yes
E – Replacement – Additional Through Lanes	Yes	Yes	No	Yes	No
F - Replacement - Single New Bridge	Yes	Yes	Yes	Yes	No
G - Construction of Third Highway Bridge	Yes	No	No	Yes	No

Initial Alternative	Screening Criteria				
	Retains Functionality	Excessive Cost	Significant Impact	Maintains Navigation	Within USACE Authority
H - Replacement - Two Tunnels	Yes	Yes	No	Yes	No
I - Replacement - Single Tunnel	Yes	Yes	No	Yes	No
J - Replacement - Low Level Draw Spans	No	No	Yes	No	Yes
K - Replacement - Causeways	No	No	Yes	No	No
L - Deauthorization and Closure of Cape Cod Canal	No	Yes	Yes	No	No

Note: Red font indicates screening criterion failure.

Sections 2.1 through 2.12 present a further description of the initial alternatives and a summary of the USACE’s determination to dismiss the alternative or advance the alternative for further evaluation.

## 2.1 Base Condition – Alternative A

Alternative A is the No-Action Alternative and consists of implementing the ongoing program of continued inspections and maintenance and repair of both existing bridges as needed to maintain safety (Fix as Fails). No major rehabilitation efforts, which would involve extensive repairs and replacement of major bridge components, would be conducted in this alternative. Structural components would be repaired, and critical elements would be replaced only when inspections indicate unsatisfactory reliability ratings.

In Alternative A, it is expected that over time, routine maintenance and minor component replacement of the bridges would result in an unacceptable structural condition. The MRER/EA indicated that both highway bridges are in deteriorated condition, well beyond the state in which actions and funding from the USACE’s operations and maintenance program could correct the deficiencies and restore and sustain reliability. It is likely that as the bridges continue to age, the repairs would not fully address the safety, efficiency, and effectiveness of the bridges. As a result, it is likely that lower vehicle weights, traffic volume restrictions, and speed limits would be required and posted to maintain continued bridge safety.

Per NEPA requirements, the USACE advanced Alternative A for detailed analysis as the base condition against which all other alternatives were compared and evaluated.

## 2.2 Major Rehabilitation of Both Bridges – Alternative B

Alternative B consists of a program of repairs and major rehabilitation of both bridges to maintain safety and avoid future restrictions on bridge weight postings. Major Rehabilitation of Both Bridges Alternative would be required for extensive repair and/or replacement of major bridge components, and it would address all known structural and other deficiencies and replace obsolete components for both bridges. As indicated in Section 1, the MRER/EA indicated that the bridges would undergo a major rehabilitation within the next ten years; thereafter, major rehabilitation of each bridge would be required about every 45 years. The USACE indicated that Alternative B would be carried out to the extent needed to delay bridge replacement for as long as practicable. However, as the bridges would continue to age and deteriorate, each instance of repair or rehabilitation could be expected to be more costly, and perhaps more frequent, than the previous instance.

The USACE advanced Alternative B to a second level of analysis to examine the ability to avoid the cost of replacement by extending the life of the bridges.

## 2.3 Replacement of One or Both Highway Bridges with New Bridges Limited to Four Lanes Each – Alternative C

The USACE identified three scenarios for highway bridge replacements for the Bourne and Sagamore Bridges, identified as Alternatives C, D, and E.

Alternative C consists of construction of two new high-level highway bridges located immediately adjacent and in similar alignment to the existing Bourne and Sagamore bridges, offset by the width of the new bridge and the needs for construction access. This alternative would retain the current two-crossing system of the existing bridges. In this alternative, each existing bridge would remain in service until the new bridge was completed.

Alternative C would, at a minimum, maintain the roadway configuration of the existing highway bridges, consisting of four travel lanes, two in each direction, and a single pedestrian/bicycle lane. In Alternative C, the width of the existing 10-foot travel lanes would be increased to 12 feet. Additional improvements would include providing for a separated and wider pedestrian and bicycle lane, limiting the bridge grades to approximately four percent, and adding shoulders. Additionally, the USACE would review and update the existing vertical clearance of 135 feet above mean high water (MHW) to account for sea level rise (SLR) projections.

Alternative C is within the USACE's authority to replace features of the FNP as necessary to serve its authorized project purposes, including the existing highway bridges. However, the USACE determined that advancing Alternative C would be contrary to best engineering practices. Alternative C would not include acceleration/deceleration (auxiliary) lanes on the bridges (proposed in Alternative D), which would not be consistent with modern highway design standards, including FHWA and MassDOT design standards. As a result, the USACE dismissed Alternative C from further evaluation.

## 2.4 Replacement of One or Both Highway Bridges with New Bridges with Four Through-Traffic Lanes and Two Auxiliary Lanes – Alternative D

Alternative D consists of Alternative C plus the additional construction of two auxiliary lanes, one in each direction, as a safety measure. In Alternative D, the replacement bridges would be constructed using current MassDOT and FHWA standards and guidelines for highway and bridge design.

Currently, there is an abrupt transition between the Bourne and Sagamore bridges and the connecting surface roads. The outer lanes of both bridges in each direction double as the acceleration/deceleration lanes to facilitate entering and exiting the bridge onto adjoining roadways. This existing condition limits unrestricted through traffic flow to one lane in each direction. In Alternative D, the proposed bridge(s) would include one auxiliary lane in each travel direction (six lanes total). The additional auxiliary lanes in each travel direction would improve traffic safety and operations by easing the effects of entering and exiting traffic merging on through traffic. Alternative D would allow for two unobstructed through travel lanes each way. Operational and safety impacts to vehicles in the right-hand travel lane in each direction due to merging and decelerating ramp traffic would be reduced. The new bridges also would include a separated path for pedestrian and bicycle traffic.

As part of the Cape Cod Canal FNP, the current Federal authorization for the Bourne and Sagamore Highway Bridges is for the maintenance of bridges with two through-travel lanes in each direction. Because the inclusion of auxiliary lanes would bring the highway bridges to current FHWA and MassDOT design and safety standards and does not add additional through-travel lanes, Alternative D is within the USACE's existing authority for operation, maintenance, repair, rehabilitation, and replacement of the Cape Cod Canal FNP project features.

With the additional auxiliary lane in each direction, Alternative D would provide two unimpeded through-traffic lanes in each direction, while improving safety for exiting and merging vehicles, and avoiding the back-up of exiting vehicles onto the through-travel portions of the bridge deck. The MRER/EA indicated that in Alternative D, improvements to the regional highway system would consist of State-implemented modifications and realignment of approach roads. The USACE noted that impacts from bridge and supporting state highway construction would be minimized by locating new bridges near the existing bridges. As a result, the USACE advanced Alternative D to a second level of analysis.

## 2.5 Replacement of One or Both Highway Bridges with New Bridges with Additional (More than Four) Non-Federally Funded Through Traffic Lanes, plus Two Auxiliary Lanes – Alternative E

Alternative E consists of Alternative D plus the construction of additional through-traffic lanes in one or both directions. With the additional through-traffic lanes, Alternative E would enable the replacement bridges to accommodate additional traffic capacity.

Alternative E is not within the USACE’s existing authority for operation, maintenance, repair, rehabilitation, and replacement of the Cape Cod Canal FNP project features. The USACE indicated that there has been not request from any non-Federal partner to include additional lanes. Therefore, the USACE dismissed Alternative E from further consideration.

## 2.6 Replacement of Both Highway Bridges with a Single New Bridge – Alternative F

Alternative F consists of replacing the existing bridges with a new single high-level fixed span highway bridge more centrally located along the canal. The single replacement highway bridge would need to meet the traffic demands of the existing bridges, which would require at least four lanes in each direction. In this alternative, the existing bridges would remain in service until the new bridge was completed.

The existing surface road system and regional highways have been designed to connect with the two existing bridges. Replacement of both bridges with a single bridge crossing would require extensive redesign of the local surface roads and regional highway connections both north and south of the canal, including utility corridors. Additionally, this alternative could require extensive property acquisitions, including from Joint Base Cape Cod, as well as substantial impacts to and/or displacement of wetlands, recreational facilities, and residential and commercial uses. Due to the relocation impacts, the USACE determined that this alternative would be substantially more expensive than constructing two smaller bridges at the existing crossing locations. As a result, the USACE dismissed Alternative F from further consideration.

## 2.7 Construction of a Third Highway Bridge– Alternative G

Alternative G consists of construction of a third highway bridge that could occur with either an ongoing system of maintenance and repairs of existing bridges (Alternative A), or major rehabilitation or replacement of the existing bridges (Alternatives B and C). The USACE noted that while a third highway bridge would reduce demand and load on the two existing bridges, this alternative would not address the underlying structural and roadway design deficiencies of the existing Bourne and Sagamore bridges and would not alleviate the need to repair, rehabilitate, or eventually replace the two bridges. Further, this alternative would require modifications to existing approaches and connecting roads.

Alternative G is not within the USACE’s existing authority for operation, maintenance, repair, rehabilitation, and replacement of the Cape Cod Canal FNP elements. While the USACE included Alternative G in its initial list of alternatives due to previous State and public interest in a third bridge, the USACE dismissed Alternative G from further consideration.

## 2.8 Replacement of One or Both Highway Bridges with a Single Tunnel or Tunnels – Alternative H

Alternative H consists of replacing one or both existing bridges with highway tunnels beneath Cape Cod Canal. The replacement tunnels would need to meet the traffic demands of the existing bridges, which would require at least four lanes in each direction. In this alternative, the existing bridges would remain in service until completion of the tunnel(s).



Replacement of one or both bridges with tunnels would have construction and operation impacts. Depending upon the method of construction and the depth of the tunnel, this alternative could require extensive relocation and realignment of the state and local road systems accessing the tunnels. Pedestrian and bicycle traffic is not permitted in tunnel due to air quality and other life safety issues. In addition, this alternative could affect future dredging and modification of the canal as a deep draft waterway. Mitigating this potential impact on the canal's future use would require incorporating additional depth into the tunnel design, resulting in additional costs, tunnel length, and modifications to the surface road network. The USACE estimated that a single 4-lane tunnel would cost more than twice that of a replacement bridge at the same location. Additional modifications to the tunnels to address potential impacts to Cape Cod Canal and would further increase costs. As a result, the USACE dismissed Alternative H from further consideration.

## 2.9 Replacement of Both Bridges with a Single Tunnel – Alternative I

Alternative I consists of replacing both highway bridges with a single tunnel. The USACE indicated that this alternative would combine the challenges of replacing the two-crossing system with a single crossing and constructing a tunnel beneath the canal instead of bridges. A single tunnel would need to meet the traffic demands of the two existing crossings, including carrying at least four lanes in each direction. As a result, more than one tunnel tube could be required. Further, pedestrian and bicycle traffic would not be accommodated in Alternative I. The USACE determined that Alternative I would result in extensive impacts to wetlands, recreational facilities, residences, businesses, and Joint Base Cape Cod. Due to these impacts and high costs tunnels, the USACE dismissed Alternative I from further consideration.

## 2.10 Replacement of One or Both Bridges with Low-Level Draw Spans – Alternative J

Alternative J consists of replacing one or both existing highway bridges with low-level draw spans (either bascule bridges or vertical lift spans). An option to this alternative would be construction of low-level fixed bridges. In this alternative, the existing bridges would remain in service until completion of the new bridge(s).

Replacement of the existing bridges with low-level draw spans would eliminate Cape Cod Canal as a deep draft commercial waterway and would conflict with the Congressionally authorized purchase and development of the canal to facilitate maritime commerce. Alternative J would restrict canal usage to all vessels except for small craft traffic that could pass beneath the bridges at limited tidal stages. Most if not all cargo and military vessels would be required to utilize the ocean route around Cape Cod and the Islands when transiting between northern New England and ports to the west and south. The remaining marine traffic would be required to wait for bridge openings to transit the canal. Given the volume of small craft traffic using the canal, construction or expansion of mooring and anchorage areas near the bridges, necessitating dredging, would be needed to allow vessels to queue-up for bridge openings. Vehicular traffic would also be impacted by bridge openings and closings. Further, draw spans require regular maintenance that would require closures to either marine or vehicular traffic. Due to these high

costs and conflicts with Congressional intent, the USACE dismissed Alternative J from further consideration.

### 2.11 Replacement of Both Bridges with Low-Level Causeways – Alternative K

Alternative K consists of replacing both existing highway bridges with low-level causeways to provide access across the canal. This alternative would convert Cape Cod Canal to an estuary; tidal flow in the canal would be preserved by the construction of large box culverts that would allow for tidal exchange. Rather than large culverts, an option to this alternative would be construction of low-level fixed bridges. In this alternative, the existing bridges would remain in service until completion of the causeways.

Alternative K would restrict use of the canal to all but the smallest craft, conflicting with the Congressionally authorized purchase and development of the canal to facilitate maritime commerce. Due to the high costs to land and marine transportation and conflicts with Congressional intent, the USACE dismissed Alternative K from further consideration.

### 2.12 Deauthorization and Closure of Cape Cod Canal – Alternative L

Alternative L consists of the deauthorization and closure of Cape Cod Canal, eliminating the canal as a navigable waterway in its entirety. All navigation between northern New England and ports to the west and south would be required to use the ocean route around Cape Cod and Island. This alternative would conflict with the Congressionally authorized purchase and development of the canal to facilitate maritime commerce and would result in the loss of an important regional commercial navigation resource. Additionally, reverting to the use of the open ocean routes would be hazardous to marine users, especially smaller recreational vessels, and could present substantial life and safety concerns.

Alternative L would require extensive fill in the canal land cut to restore the natural drainage and estuarine and coastal ecosystem. The USACE indicated that from the Federal purchase of Cape Cod Canal to the completion of the 1941 Canal improvement project, approximately 40.5 million cubic yards of material were dredged from the canal land cut and sea approaches. While records do not indicate how much of the total fill volume was from the land cut, even if half of the total dredged amount were required to reclaim the canal area, the cost would be a substantial. The USACE estimated that total costs of the area reclamation would likely be several hundred million dollars.

Alternative L would be contrary to the Congressionally authorized purchase and development of the canal to facilitate maritime commerce and is not within the authority of the USACE. As a result, Alternative L was dismissed from further consideration.

## 3 Detailed Alternatives Evaluation

Table 3-1 lists the three alternatives that the USACE advanced for further consideration. Each of the alternatives would be within the USACE's existing authority for operation, maintenance, repair, rehabilitation, and replacement of the Cape Cod Canal FNP project features.

Table 3-1. Alternatives Advanced for Detailed Analysis

Alternative	Description	Considerations
<b>A</b>	Base Condition. Maintenance and repair of both bridges would continue without any major rehabilitation. Bridge components would be repaired or replaced when inspections yield unsatisfactory reliability ratings.	No-Action Alternative
<b>B</b>	Major Rehabilitation. All known structural, mechanical, and electrical deficiencies would be addressed and obsolete components replaced on both bridges to maintain safety and avoid future postings of bridge weight restrictions.	Major rehabilitation of each bridge would be required about every 45 years.
<b>D</b>	Replacement of One or Both Highway Bridges with New Bridges having Four Through-Traffic Lanes and Two Acceleration/Deceleration Lanes. A full replacement bridge would be built parallel to one or both existing bridges. Each new bridge would include four vehicle travel lanes and two auxiliary lanes to facilitate safe exit and entrance from the connecting surface roads. A pedestrian/bicycle lane would also be included.	Each existing bridge would remain in service until completion of the new bridge.

The USACE conducted an extensive engineering and economic analysis of the existing highway bridges, their rehabilitation, and alternatives to major rehabilitation. To assess the current and anticipated condition of the bridges, the USACE rated major structural components using National Bridge Inspection Standards and determined likely future changes in physical condition through a fatigue analysis and corrosion analysis.

In the economic analysis, the USACE evaluated the base condition and then compared that condition to the alternatives. Annual benefits considered for each alternative included the reduction in emergency repair spending, the decrease in traffic delays, and changes in cost to waterway navigation. The annual benefit of each alternative was then compared to its respective cost. The USACE considered an alternative to be economically justified if it maximizes net annual benefits and its benefit cost ratio (annual benefit divided by annual cost) is greater than one.

Costs were developed for the alternatives in accordance with USACE regulations, manuals, and directives.<sup>4</sup> The overall cost of each alternative included several elements, consisting of the cost of the repair itself, the economic cost to vessels that would not be able to use the canal (navigation costs), operation and maintenance costs, and the change in value of time incurred by drivers in traffic delays (travel costs) during lane closures for repairs or construction phases. Cape Cod traffic study data and

<sup>4</sup> Details are provided in Appendix C, Cost Engineering, of the Major Rehabilitation Evaluation Report.

forecasts were used to determine the total hours of traffic delay incurred during construction for all travelers crossing the bridges. The USACE attributed a monetary value to the lost productive hours using the average hourly household median income of the surrounding towns as sourced from the U.S. Census Bureau.

The USACE developed a rough order of magnitude cost estimate for a program of major rehabilitation for each of the two bridges. The USACE also assessed the impacts of service disruptions due to emergency repairs, including vehicular and navigation traffic management during major rehabilitation.

To evaluate the alternatives to major rehabilitation of the two highway bridges, the USACE considered the expected performance, reliability and engineering risk of each alternative and compared the alternatives to the base condition to determine their relative effectiveness, cost and impacts toward the goal of providing safe and reliable long-term vehicular access across Cape Cod Canal. In calculating bridge replacement costs, the USACE considered the following: 1) bridge costs, including new bridge construction costs, associated state highway modifications, real estate interests, and utility relocation costs; 2) traffic management during bridge replacement, including vehicular and marine traffic management; and 3) future operation, maintenance, and repair costs for the replacement bridges.

### 3.1 Alternative A – Base Condition

Based on the economic analysis, the USACE determined that Alternative A, the Base Condition, would lead to escalating costs, particularly costs for travelers delayed in traffic.

In the Base Condition, in which there would be no major rehabilitation or replacement of the existing bridges, the USACE assumed that continual, regularly scheduled maintenance would be performed on the existing structures and emergency funds would be provided in the event of performance failure. Travel delays due to lane or bridge closures would be expected during necessary maintenance and repair projects. The cost of these repairs and the cost of traffic delays represent the cost of this alternative.

The USACE determined that Alternative A would result in escalating impacts on vehicle traffic and the economy of Cape Cod and the Islands. Large trucks transporting critical goods and services would be replaced by additional, smaller trucks traveling at reduced speeds, leading to rising costs to transport goods on and off Cape. Further, there would be an increase in vehicle emissions and lengthier traffic delays, potentially adversely impacting tourism.

### 3.2 Alternative B – Major Rehabilitation

The USACE determined that Alternative B, major rehabilitation of both existing bridges, demonstrated advantages and disadvantages. Major rehabilitation of both the Sagamore and Bourne bridges would improve the reliability of the bridges and reduce the likelihood of component failure. Benefits of Alternative B would represent a reduction in emergency repair costs following a component failure and associated time value costs from lane closures related to these repairs. In comparison to the Base Condition (Alternative A), the USACE determined that benefits of Alternative B would outweigh its costs, which includes both construction costs and value of time costs from traffic delays.

While the Major Rehabilitation Alternative would have a lower initial construction cost compared to replacing the bridges, it would have an adverse impact on traffic patterns during construction due to lane and full bridge closures. The USACE estimated that major rehabilitation of each bridge would take approximately 3.5 years to complete. With the need to divert traffic between the two bridges during rehabilitation, maintain sufficient traffic capacity, and lessen adverse impacts to traffic throughout the rehabilitation duration, the USACE determined that only one bridge would be worked on at a time. Lane and bridge closures would not occur Memorial Day through Columbus Day, nor on Patriots Day or Thanksgiving weekends, to avoid impacting the tourist travel season. Further, construction would be limited during the winter months. This would result in an overall six to eight-year construction period for the rehabilitation of both bridges. The USACE estimated that major rehabilitation work would result in only minimal delays to marine navigation; however, sufficient roadway traffic capacity would not be maintained in this alternative. The USACE estimated that the Major Rehabilitation Alternative would result in substantial adverse impacts to vehicular travel. Based on engineering judgement and similar work performed at other bridges, the USACE estimated that major rehabilitation of the bridges would result in 480 days of lane closures and 180 days of bridge closures at the Bourne Bridge and 380 days of lane closures and 130 days of bridge closures at the Sagamore Bridge. In sum, the impact of traffic delays would be a major component in adding to the costs of Alternative B.

Further, in Alternative B, the bridges would not be brought up to current engineering standards and regulations. The USACE determined that the Major Rehabilitation alternative would present higher risks, as continued deterioration over time and escalating frequency of future repairs and additional rehabilitation could warrant the need for replacement in the future.

### 3.3 Alternative D – Bridge Replacement with Six Lanes

Alternative D, the bridge replacement alternative, had higher net benefits and a higher benefit-cost-ratio than the Major Rehabilitation alternative (Alternative B) and the Base Condition (Alternative A). One disadvantage of the new bridges would be the high initial construction cost. However, the USACE determined that the Bridge Replacement Alternative would result in more reliable bridges that meet current engineering design and safety standards and regulations. The improved reliability would substantially decrease the probability of bridge failure and resulting costs associated with emergency repair and associated time value costs from lane closures. Additionally, there would be lower annual operation and maintenance (O&M) costs after the erection of the replacement bridges. Because the existing bridges would remain in service until the new bridges opened to traffic, lane and bridge closures would not be required during their construction. There would be limited impacts to vehicular traffic and impacts to navigation during construction. Finally, during minor repairs and inspections, bridges with auxiliary lanes would result in less traffic delays as two lanes in each direction could remain open in many circumstances.

The USACE noted that its economic analysis was performed under the assumption that the infrastructure and surrounding roadways to the bridges would remain in their current conditions and

would not be upgraded by the Commonwealth of Massachusetts. The USACE determined that if the State chose to improve the road network surrounding the bridges as proposed in MassDOT's Cape Cod Transportation Study, particularly near the Bourne Rotary, then the Bridge Replacement Alternative would provide additional efficiency benefits. This alternative would improve travel time by allowing the left-hand travel lanes to be fully used by through traffic, since exiting and entering traffic would use the acceleration/ deceleration lanes. The benefits of improved travel time could increase the net annual benefits and benefit-cost-ratios. Further, shifting the exiting and entering traffic out of the right-hand through traffic lanes also would have traffic safety benefits, as conflicts between fast-moving and slow-moving vehicles would be minimized. Additionally, the USACE determined that Alternative D could reduce impacts to the traveling public when future maintenance on the bridges is performed.

## 4 MRER/EA Highways Bridges Preferred Alternative

The USACE determined that the Preferred Alternative for the Bourne and Sagamore highway bridges would be replacement of both highway bridges with new bridges having four through-traffic lanes and two acceleration/deceleration (auxiliary) lanes. Actual bridge type and other design parameters would be developed in the next phase of the Cape Cod Bridges Program. Final design would conform to American Association of State Highway and Transportation Officials (AASHTO) , FHWA, and MassDOT design standards current at that time.

The MRER/EA Preferred Alternative for the replacement highway bridges includes the following design parameters at the conceptual design level:

- Construction of two new highway bridges each located parallel to and immediately inshore of the existing Bourne and Sagamore Bridges.
- Each new bridge would include four 12-foot-wide through travel lanes, two in each direction.
- Each new bridge would have two 12-foot-wide auxiliary lanes for entrance and exit, one in each direction.
- Each new bridge would have a minimum vertical clearance for navigation of 135 feet above mean high water (MHW) over the width of the navigation channel, increased 7.8 feet for anticipated sea level change (high rate).
- Each new bridge would have deck and approach grades no steeper than 4 percent.
- Each new bridge would include one non-vehicular lane for pedestrian and bicycle traffic with separation between the non-vehicular lane and the vehicle traffic lanes.
- Each new bridge would include shoulder width on the vehicle deck.
- Each new bridge would include a median to separate northbound and southbound vehicular traffic.
- The existing bridges would remain in service with operation, maintenance, and repaired as needed, until the new bridges are opened to traffic.
- The existing bridges would be demolished upon opening of the new bridges.

Figure 4-1 shows the MRER/EA's Preferred Alternative concept for the replacement bridges.

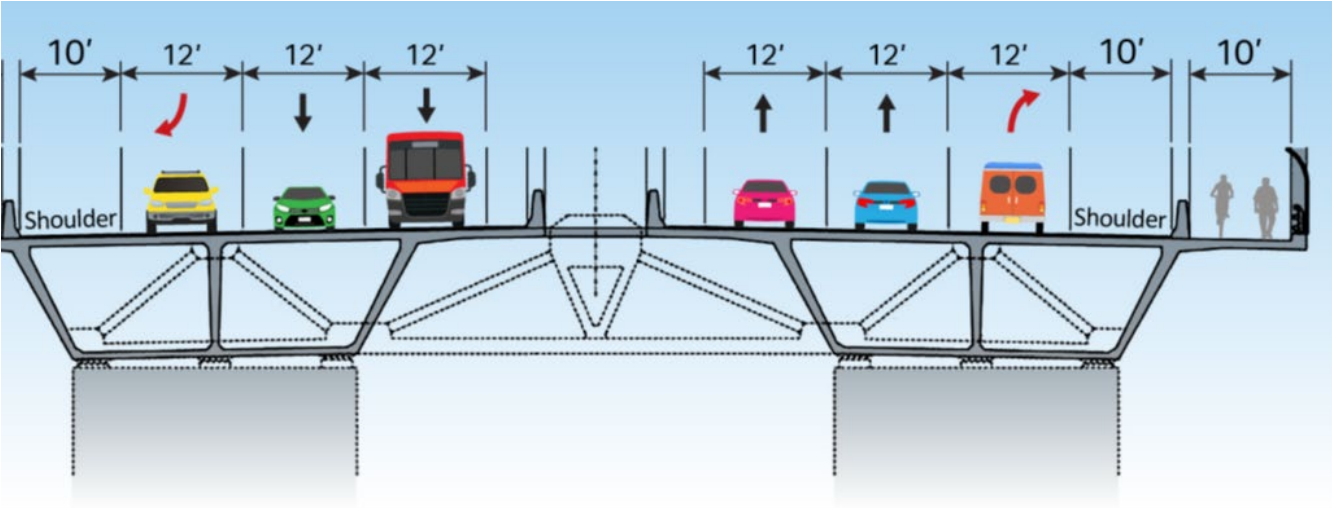


Figure 4-1. MRER/EA Preferred Alternative: Conceptual Bridge Replacement

# Massachusetts Department of Transportation Cape Cod Bridges Program Phase 1 and Phase 2 Assessments

## 1 Introduction

The Massachusetts Department of Transportation (MassDOT), in coordination with the Federal Highway Administration (FHWA) as the lead federal agency and the New England District of the U.S. Army Corps of Engineers (USACE) as a cooperating agency, is preparing environmental analyses and documentation for the Cape Cod Bridges Program in compliance with the National Environmental Policy Act [NEPA; 40 Code of Federal Regulations (CFR) Parts 1500–1508 and FHWA’s issued regulations, *Environmental Impacts and Related Procedures* (23 CFR 771)] and the Massachusetts Environmental Policy Act [MEPA; Massachusetts General Law (MGL) Chapter 30, Sections 61 through 62I, and its implementing regulations, 301 Code of Massachusetts Regulations (CMR) 11.00, as amended January 6, 2023]. As required by NEPA and MEPA, MassDOT has prepared this Alternatives Assessment to document bridge design options and highway interchange approach alternatives that were considered, and then either dismissed or advanced for further analysis.

### 1.1 Cape Cod Bridges Program Study Area

The Cape Cod Bridges Program Study Area, shown in Figures 1-1 and 1-2 as two distinct study areas, includes the areas of the existing bridges and highway approach interchanges for each crossing.

The Bourne Program Study Area includes the Route 25 and Route 28 approaches to the bridge. North of Cape Cod Canal, roadways include Route 6 (Scenic Highway) and the roadways approaching Belmont Circle, including the Route 25 exit- and entrance-ramps and portions of the Head of the Bay Road, Main Street, and the Buzzards Bay Bypass. South of the canal, roadways include the Bourne Rotary and approach roadways including Route 28, Sandwich Road, and Trowbridge Road, Veterans Way, and the Bourne Rotary Connector.

The Sagamore Program Study Area includes the Route 3 and Route 6 approaches to the bridge. North of Cape Cod Canal, roadways include the Scenic Highway and Meetinghouse Road approaches, the Route 3/Scenic Highway interchange, and portions of Canal Street and State Road. South of the canal, roadways include Cranberry Highway and Sandwich Road and Route 6 itself extending south of the Mid-Cape Connector ramps to Route 6.



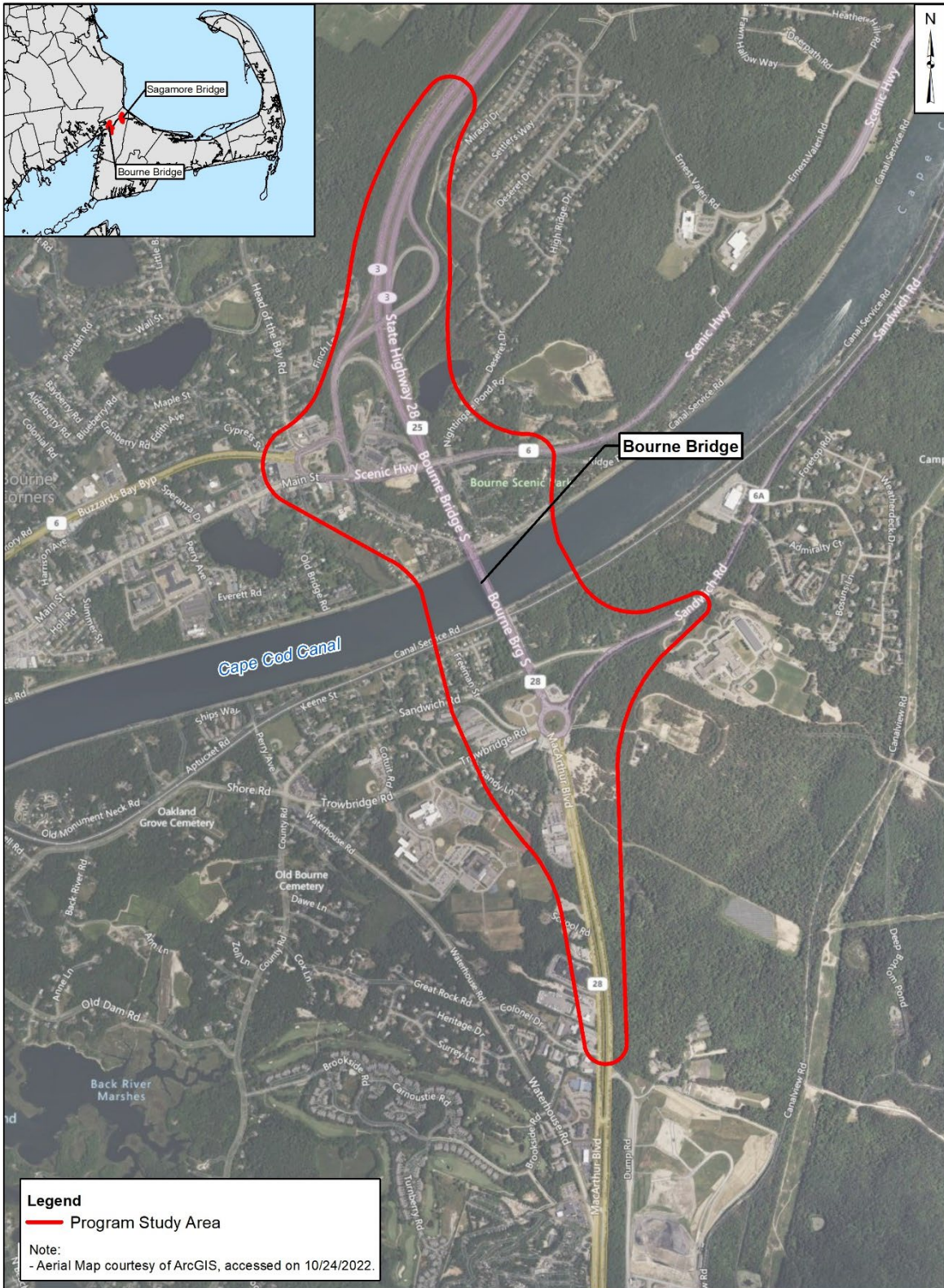


Figure 1-1. Cape Cod Bridges Program - Bourne Program Study Area

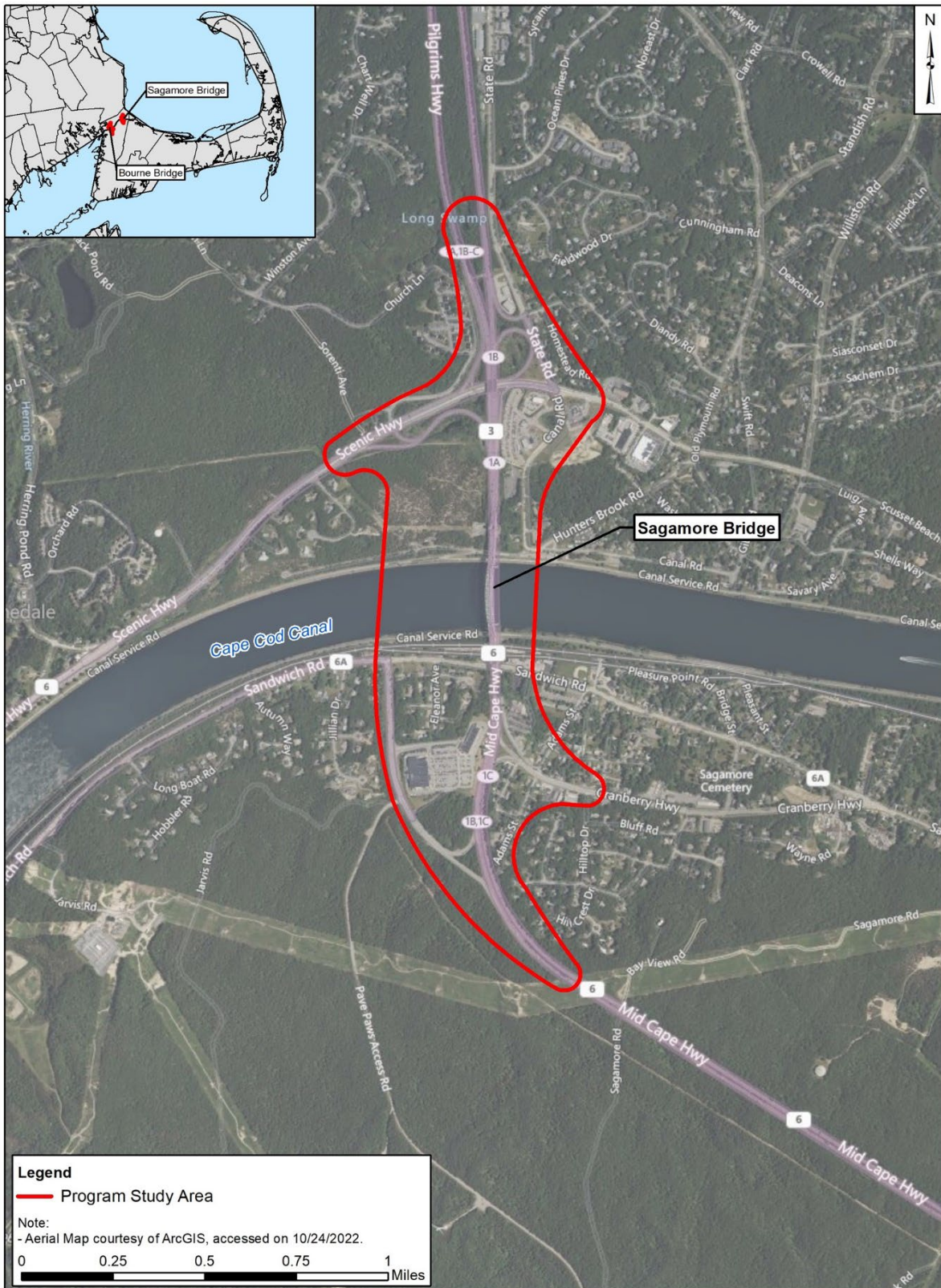


Figure 1-2. Cape Cod Bridges Program – Sagamore Program Study Area

## 1.2 Program Purpose and Need

### 1.2.1 PROGRAM PURPOSE

The purpose of the Cape Cod Bridges Program is to improve cross-canal mobility and accessibility between Cape Cod and mainland Massachusetts for all road users and to address the increasing maintenance needs and functional obsolescence of the aging Cape Cod Canal highway bridges. The Program will improve traffic operations and multimodal accommodations to facilitate the dependable and efficient movement of people, goods, and services across Cape Cod Canal.

### 1.2.2 PROGRAM NEEDS

In coordination with FHWA and USACE, MassDOT is undertaking the Cape Cod Bridges Program to address the following needs, or deficiencies of the Bourne and Sagamore bridges and their roadway approach networks for road users crossing Cape Cod Canal: structural deficiencies of the Bourne and Sagamore bridges, including their frequent maintenance requirements; substandard design of the Bourne and Sagamore bridges, including the approaches and their interface with the adjacent roadway network; and peak period congestion and poor traffic operations.

## 1.3 MassDOT's Alternatives Assessment Process

Utilizing the USACE's MRER/EA as the foundational document for the Cape Cod Bridges Program, MassDOT's Phase 1 and Phase 2 assessments incorporate the MRER/EA's Preferred Alternative: Replacement of Both Highway Bridges with New Bridges with Four Through-Traffic Lanes and Two Auxiliary Lanes (In-Kind Bridge Replacement, updated to comply with federal and state highway and design safety standards).

In coordination with USACE and FHWA, MassDOT conducted extensive analysis of multiple design parameters for the development of the Cape Cod Bridges Program. In the Phase 1 and Phase 2 assessments, MassDOT evaluated, confirmed, and expanded upon the design parameters identified in the MRER/EA's Preferred Alternative. This Alternatives Assessment summarizes key Phase 1 and Phase 2 assessments MassDOT has conducted to date for the Cape Cod Bridges Program:

- Phase 1 Bridge Highway Assessments: Highway Cross-Section and Shared Use Path;
- Phase 1 Bridge Assessment: Vertical and Horizontal Clearances;
- Phase 1 and Phase 2 Bridge Assessments: Main Span Length and Bridge Pier Location;
- Phase 1 and Phase 2 Bridge Assessments: Bridge Deck Configuration;
- Phase 1 and Phase 2 Bridge Assessments and Community Review: Bridge Types;
- Mainline Alignment Location Assessment;
- Phase 1 Highway Interchange Approach Assessments.

MassDOT's Phase 1 and Phase 2 assessments consist of qualitative evaluations of Program parameters screened by a set of design criteria established in coordination with FHWA and USACE. For the Phase 1 and Phase 2 bridge assessments, no distinction is made between the Bourne and Sagamore crossings; the assessments made at this conceptual and preliminary level of design apply to both replacement bridges.

Additionally, MassDOT qualitatively evaluated mainline alignment locations for each bridge crossing. The Phase 1 highway interchange approach assessments consist of evaluations for the two bridge crossings, further broken down by off-Cape and on-Cape alternatives.

As design advances, MassDOT will conduct the Phase 2 highway interchange approach assessments. The results of the Phase 2 analysis and identification of the Preferred Alternative for the highway interchange approaches at the bridge crossings will be reported in the Draft Environmental Impact Report (DEIR) and the NEPA document.

MassDOT's alternatives analysis process is supported by four appendices that document the decisions summarized in this report:

- Appendix A provides the Cape Cod Bridge Replacements Initial Screening Report (HNTB, 2021), which documents the multiple bridge parameters that MassDOT evaluated in Phase 1.
- Appendix B provides the Cape Cod Bridge Replacements Constructability Assessment (HNTB, 2021), which evaluates the Phase 1 favorable bridge configurations for various aspects of constructability, including fabrication, material transport, erection methodology, and impacts to canal and canal-side traffic.
- Appendix C provides the Cape Cod Bridge Replacements Phase II Screening Report (HNTB, 2022), which documents the secondary screening process that resulted in a preferred bridge type option for the replacement of the Bourne and Sagamore highway bridges.
- Appendix D provides the conceptual identification and screening assessment of a wide range of highway interchange approach configurations that resulted in a Phase 1 evaluation of 22 interchange approach options for the Bourne and Sagamore crossings.

## 2 Phase 1 Bridge Highway Assessments

### 2.1 Bridge Highway Cross-Section

MassDOT evaluated the composition and dimensions of the proposed bridge highway cross-section and the maximum profile grades relative to the MRER/EA's recommendations that each new bridge would include four 12-foot-wide through travel lanes, two in each direction; a shoulder; separation median; and deck and approach grades no steeper than 4 percent. The design of the proposed cross section composition and dimensions to be consistent with MassDOT and AASHTO design criteria.

According to MassDOT's Road Inventory File, the federal functional classification for Route 3, Route 6, Route 25, and Route 28 (except for Route 28 south of and including the Bourne Rotary) is identified as Principal Arterial – Other Freeways. Expressway Route 28 has a federal functional class of Principal Arterial – Other, from the Bourne Rotary to the Otis Rotary, approximately four miles south of the Bourne Rotary. To align with the roadway type and context, including roadway users' expectations

regarding approach speeds and average running speeds, the Bourne replacement bridge (Route 28) would have a design speed of 55 miles per hour (MPH) and the Sagamore replacement bridge (Route 6) would have a design speed of 60 MPH.

Considering the functional classification and the rolling terrain at both bridge sites, MassDOT evaluated the appropriate profile grade for each highway bridge. MassDOT proposes a maximum grade of 4.5 percent for the Bourne replacement bridge and a maximum grade of 4 percent for the Sagamore replacement bridge. The proposed grades would be considerably flatter than the existing bridge grades of 6 percent. The flatter grades would improve safety by reducing the effect of the speed differential for trucks approaching the crest of the bridges, and they would reduce the likelihood of trucks and other vehicles becoming stuck during snow and ice events.

To confirm the USACE's decision to include auxiliary lanes in the replacement highway bridge roadway design, MassDOT evaluated design criteria that would warrant a continuous auxiliary lane over the bridge structures, including interchange spacing, traffic operations, geometric guidelines, and constructability. Per AASHTO highway design standards for adequate acceleration lane, deceleration lane, and taper lengths for interchange access to the bridges north and south of the canal crossings, a continuous auxiliary lane in each direction for the full length of the Sagamore Bridge and the southbound direction of the Bourne Bridge is required. For the northbound Bourne Bridge crossing, the constructability of the bridge and the need to accommodate users during construction necessitates the additional structure width.

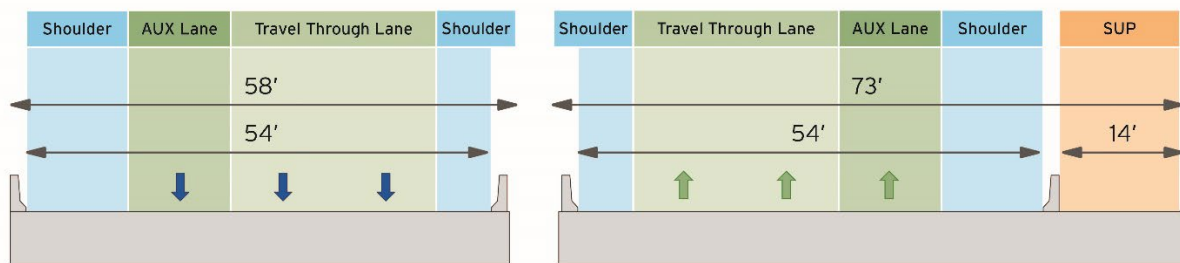
## 2.2 Shared Use Path

The conceptual design for the MRER/EA's Preferred Alternative included a single dedicated 10-foot-wide shared use path for pedestrians and bicyclists for each crossing. The proposed shared use paths would be designed in accordance with MassDOT, AASHTO, and FHWA design criteria, as well as the Americans with Disabilities Act (ADA) and the Architectural Access Board's guidance. The shared use paths on the Bourne and Sagamore Bridges would follow the proposed mainline roadway profiles and, where possible, the grades would be reduced on the approaches to the bridges. MassDOT is continuing to evaluate the options for the width of the shared use path, to be determined as design advances.

Figure 2-1 presents a schematic of the bridge highway cross-section at the Bourne and Sagamore crossings.<sup>5</sup>

---

<sup>5</sup> MassDOT has not determined the total width of the shared use path. A 14-foot-wide shared use path is shown for illustrative purposes only.



**Figure 2-1. Replacement Bridge Highway Cross-Section**

MassDOT determined that the highway deck would include two 12-foot-wide through travel lanes, a 12-foot-wide entrance/exit (auxiliary) lane, a 4-foot-wide left shoulder, and a 10-foot-wide right shoulder. Right and left barriers would be offset an additional 2 feet beyond the limits of the shoulders, for a total structure width of 54 feet curb to curb. Additionally, each bridge crossing would include one bi-directional pedestrian and bicycle shared use path (SUP), separated from vehicular traffic by the shoulder and barrier. As design advances, MassDOT will determine the width of the shared use path.

## 3 Phase 1 Bridge Assessment: Vertical and Horizontal Clearances

### 3.1 Bridge Vertical Clearance

In the MRER/EA, the USACE determined that the new bridge vertical clearances should account for future sea level rise (SLR), provided the 135-foot clearance of the existing bridges were to remain as a goal for navigable transit of Cape Cod Canal by auto carriers and cruise ships, the largest ships currently using the canal.

MassDOT evaluated the SLR projections included in the MRER/EA relative to current resources, including data from the National Oceanic and Atmospheric Administration (NOAA) and the Massachusetts Climate Change Projections, issued by the Massachusetts Executive Office of Energy and Environmental Affairs (EEA). Accordingly, MassDOT proposes to increase the vertical clearance of the existing bridges by 3.18 feet, which aligns with the most recent downscaled SLR data provided by NOAA (2022). Both replacement bridges would be designed for a vertical clearance of approximately 138 feet above MHW.

### 3.2 Bridge Horizontal Clearance

In the MRER/EA, the USACE indicated that increasing the horizontal clearance for navigation should be considered with the replacement bridges. The existing Bourne and Sagamore bridges have piers located within the canal cut, seaward of the slope protection but outside of the channel limits. The channel has a bottom cut width of 480 feet within the land cut reaches, including between the bridges.

In collaboration with USACE, MassDOT proposes that the replacement bridge structures provide a minimum of 500 feet of horizontal navigational width, to be consistent with existing conditions.

## 4 Phase 1 Bridge Assessment: Main Span Length and Bridge Pier Location

The bridge piers for the existing Bourne and Sagamore bridges support a main span of 616 feet. MassDOT identified and screened options for the main span length and location of bridge piers for the replacement bridges.

### 4.1 Main Span Length and Pier Location Options

Incorporating the MRER's Preferred Alternative for In-Kind Bridge Replacement, MassDOT evaluated two options for the replacement bridge pier locations: In-Water and Out-of-Water options. The In-Water Span Option includes two approximate main span lengths: 525 feet and 616 feet. The shortest possible span length of 525 feet is dictated by the minimum required horizontal clearance of 480 feet between the edges of the footings.<sup>6</sup> The 616-foot span length equals the span length of the existing bridges, thereby maintaining the status quo for channel operations. The Out-of-Water Span Option includes two approximate main span lengths: 700 feet and 820 feet. A medium span length of 700 feet locates the piers within the rip rap slope and above the low tide line. A longer span length of 820 feet locates the piers entirely on land.

### 4.2 Main Span and Bridge Pier Screening Methodology

In the MRER/EA, the USACE noted that locating any new piers on land outside of the canal cut would require moving the pier locations landward by about 50 feet on each shore. This would open the horizontal clearance, improve navigational safety, and make access to the piers for inspection and maintenance easier. It would also require lengthening of the spans over the waterway.

In coordination with USACE and FHWA, MassDOT evaluated the main span lengths with respect to the following design criteria, using an unscaled, qualitative rating scheme to facilitate the screening:

- Initial Costs, consisting of a qualitative assessment of main span structure and main span foundations.
- Main Span Footings, including potential for vessel impact and scour.
- Construction, including duration of construction, constructability, impact on canal traffic, and environmental impact.

### 4.3 Main Span and Bridge Pier Screening Results

Table 4-1 presents the screening results of bridge pier locations and main span length options. Based on its easier constructability by land, its substantially reduced impacts to environmental resources and navigation, and the preferences of the USACE as the operator of Cape Cod Canal, MassDOT determined

---

<sup>6</sup> Early coordination with the USACE identified a 480-foot horizontal channel width requirement. Subsequent to this Phase 1 analysis, MassDOT confirmed a 500-foot horizontal channel width requirement with the USACE.

that the Out-of-Water Option, including both medium span and long span variations, is the Preferred Option for the bridge pier locations for the Bourne and Sagamore replacement highway bridges.

Table 4-1. Summary of Main Span Length and Bridge Pier Location Options

Design Evaluation Criteria <sup>a</sup>	Pier Locations			
	In-Water Option		Out-of-Water Option	
	Minimum/525 feet	Existing/616 feet	Shore Line Piers/700 feet	Land Piers/820 feet
<b>Cost</b>				
• Main Span Structure	●●	●	●	●●
• Main Span Foundation	●●	●●	●	●●
<b>Main Span Footings</b>				
• Vessel Impact	●●●	●●	●●●	●●●
• Scour	●●	●●	●●	●●●
<b>Construction</b>				
• Duration	●	●	●	●
• Constructability	●●	●	●●	●●
• Impact on Canal Traffic	●●	●	●●	●●●
• Environmental Impact	●●	●●	●	●●

a. ●●● Most favorable; ●● Favorable; ● Neutral; ●● Less Favorable; ●●● Unfavorable; ●● Not Rated

Sections 4.3.1 and 4.3.2 discuss Table 4-1 ratings and MassDOT’s decisions to advance or dismiss bridge pier locations for advanced design and further evaluation.

### 4.3.1 OPTION ADVANCED FOR FURTHER EVALUATION: OUT-OF-WATER PIERS

#### 4.3.1.1 700-Foot Span

A medium main span length of approximately 700 feet would locate the replacement bridge piers at the waterline adjacent to the service road (shoreline piers), into the rip rap slope but above the low tide line, as shown in Figure 4-1.

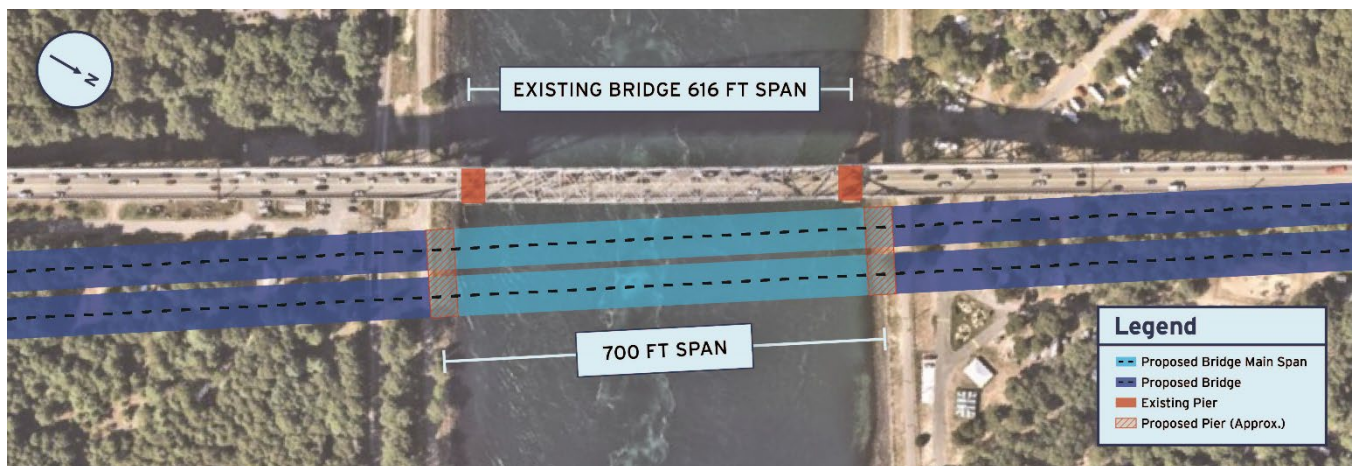


Figure 4-1. Main Span and Pier Location Out-of-Water Option – Approximate 700-Foot Span Length



*Initial Costs Rating: Neutral*

The pier construction would be from the land, which would be easier than construction from the water; however, the foundation installation would require some land-based installation of sheeting for work in the tidal zone.

*Main Span Footing Rating: Favorable to Most Favorable*

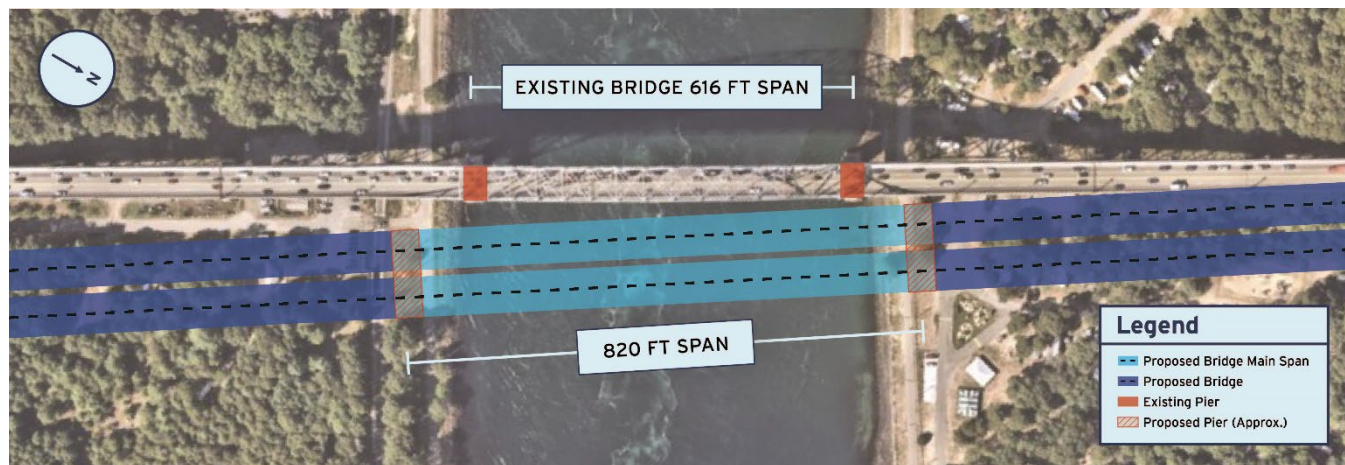
With an approximate 700-foot span, the piers would be located outside the waterway and in the rip rap, and the potential for off-course vessels to impact the piers would be substantially reduced. With an armored slope, the 700-foot span receives a favorable rating regarding the potential for scour. Because the longer spans would effectively improve navigation conditions, the USACE indicated a preference for medium to long mainline span lengths.

*Construction Rating: Neutral to Favorable*

In this option, there would be no channel fouling. Pier construction would be from the land; however, the installation of sheeting would require work in the water and impact water quality.

**4.3.1.2 820-Foot Span**

A long main span length of approximately 820 feet would locate the replacement bridge piers entirely on land (land piers), as shown in Figure 4-2.



**Figure 4-2. Main Span Out-of-Water Option – Approximate 820-Foot Span Length**

*Initial Costs Rating: Less Favorable to Favorable*

The longest span length would have the highest superstructure costs relative to the other span lengths. Because it would provide the best accessibility for foundation construction, via the land, the 820-foot span length receives a favorable rating for the main span foundation costs.

*Main Span Footing Rating: Most Favorable*

There would be no impact to vessels or canal traffic and no potential for scour with an approximate 820-foot main span length. Because the longer spans would effectively improve navigation conditions, the USACE indicated a preference for medium to long mainline span lengths.

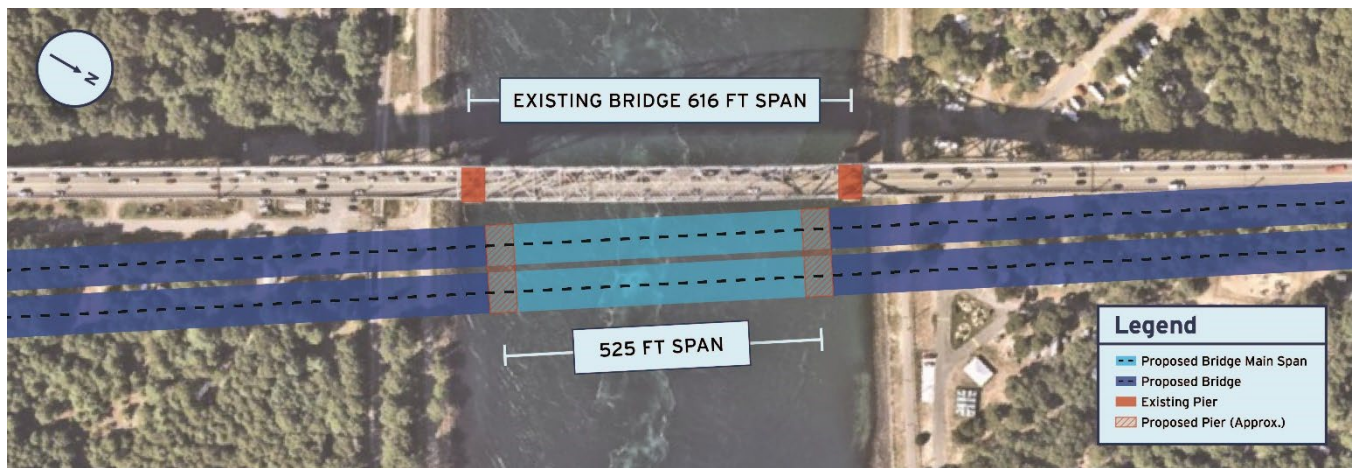
*Construction Rating: Neutral to Most Favorable*

This option would involve a more difficult superstructure. With an 820-foot option, there would be no channel fouling. With construction only on land, there would be no impacts to the waterway, but the land location would impact the USACE's existing service roads along each bank.

### **4.3.2 OPTION DISMISSED FROM FURTHER EVALUATION: IN-WATER PIERS**

#### **4.3.2.1 525-Foot Span**

A main span of approximately 525 feet would locate the bridge piers just outside the navigational limits, as shown in Figure 4-3.



**Figure 4-3. Main Span In-Water Option – Approximate 525-Foot Span**

*Initial Costs Rating: Less Favorable to Favorable*

This option would have the lowest superstructure cost in comparison to the other main span lengths, but it would have the highest foundation costs relative to the other span lengths. Due to their location just outside the navigation channel limits, the piers would be designed and constructed to withstand vessel impacts, which would increase construction costs. Additionally, this option would require a full marine cofferdam for construction, increasing costs.

*Main Span Footing Rating: Less Favorable to Unfavorable*

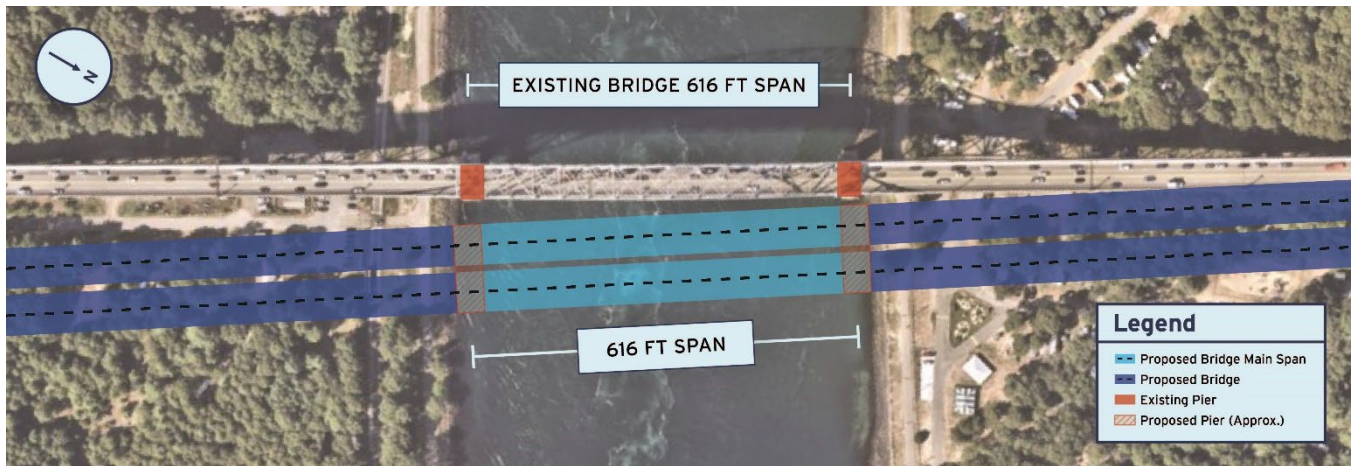
The USACE indicated that the shortest span of 525-feet would not be acceptable for canal navigation operations; locating the main span footings at the channel limits would increase the potential for vessel impacts and would adversely impact existing navigation conditions.

*Construction Rating: Neutral to Most Favorable*

The piers would be constructed from the water using a cofferdam, with access from the water via a construction trestle (work platform). Construction and operation of this main span length would impact environmental resources, including water quality, with a potential for scour and a high propensity for channel fouling.

#### **4.3.2.2 616-Foot Span**

A mainline center span length of approximately 616 feet would locate the replacement bridge spans outside the navigation channel and closer to the shoreline, as shown in Figure 4-4.



**Figure 4-4. Main Span In-Water Option –Approximate 616-Foot Span Length**

*Initial Costs Rating: Less Favorable to Neutral*

Like the 525-foot short span, the 616-foot main span would incur high foundation costs relative to the out-of-water option; it would require construction from the waterway via a construction trestle with a cofferdam in the waterway.

*Main Span Footing Rating: Less Favorable*

While this span length would not alter existing navigation conditions, the USACE indicated that longer bridge spans would be preferred. This option would have a potential for impacts to the pier foundations by small vessels and shallow draft barges. Currently, the footings do not have substantial scour, therefore scour in this option would not be likely.

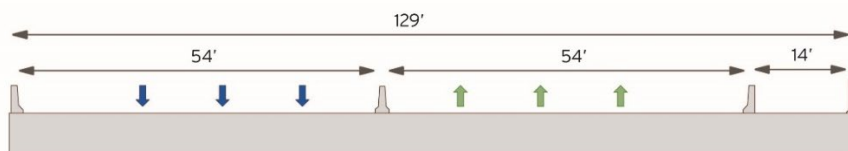
*Construction Rating: Less Favorable to Neutral*

The piers would be constructed from the water using a cofferdam, with access from the water via a construction trestle (work platform). Construction and operation of this mainline span length would impact environmental resources, including water quality.

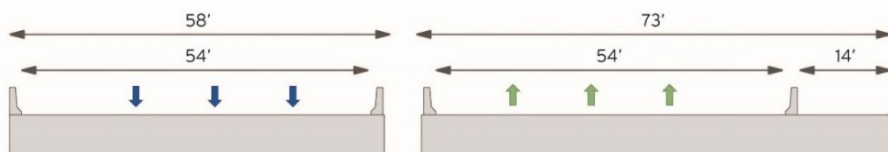
## 5 Phase 1 Bridge Assessment: Bridge Deck Configuration

To accommodate the roadways, shoulders, and pedestrian/bicycle path, the required roadway width of a single deck for the highway bridges would be substantial (approximately 129 feet), necessitating a roadway deck with large floor beams. Constructing a single wide deck would add a level of complexity associated with transportability, potentially resulting in larger float-in weights and sizes, larger crane requirements for erection, and interim stability. Additionally, a single deck configuration would have a greater structure depth, requiring a steeper or longer approach on both sides of the canal. The constructability challenges of a single roadway deck would increase overall project costs.

As a variation of the single deck configuration for the highway bridge mainline presented in the MRER/EA, MassDOT investigated constructing separate deck structures for each replacement highway bridge mainline, consisting of two parallel separate northbound and southbound decks (barrels). Separate structures would use cost-effective, smaller construction elements with a shallower floor beam depth, which would simplify fabrication and erection. Additionally, separate structures would allow for phased construction of parallel bridge structures, facilitating an earlier decommissioning and demolition of the existing highway bridges than with a single deck. In a two-deck approach, one replacement highway bridge span would be erected first and carry two-way traffic in a temporary configuration, providing the same number of travel lanes as the existing highway bridge. The next phases would be to demolish the existing bridge and construct the second bridge. The last phases would be to route traffic onto separate northbound and southbound structures and reconfigure the first highway bridge for one-way traffic. Figures 5-1 and 5-2 show a schematic comparison of the single deck and separate deck configurations.<sup>7</sup>



**Figure 5-1. Bridge Structure Configuration with a Single Deck**



**Figure 5-2. Bridge Structure Configuration with Separate Decks**

In a phased construction approach, a new structure, albeit in a temporary configuration, would be available more quickly than with single-stage construction; however, the overall construction time might be longer. Single-phase construction might shorten the overall schedule; however, the existing highway bridges would need to remain in service longer than in a phased construction approach. Extending the service period of the existing Bourne and Sagamore bridges not only would require a continued maintenance and repair program of the functionally obsolete and deteriorating bridges, but also could trigger an extensive rehabilitation of bridge components to extend their useful life and to avoid weight restrictions, lane reductions, and/or lane closures.

<sup>7</sup> MassDOT has not determined the width of the shared use path; the 14-foot-wide path is shown for illustrative purposes only.

A replacement highway bridge with two separate deck structures would have a larger footprint than one with a single deck structure due to the need to provide adequate spacing, approximately 10 feet, between the individual structures.

Two separate deck structures would provide long-term benefits relative to the life of the bridge that the single deck span would not offer. The two individual roadway deck structures would provide structural redundancy and would facilitate inspection, maintenance, and replacement, as each structure could operate independently. Further, separate bridge structures at each crossing would provide advantages in case of an emergency evacuation or a compromising event impacting a single bridge structure.

Based on the Phase 1 assessment, which identified advantages and disadvantages of each option, MassDOT determined that both bridge deck configurations would be feasible and advanced the single deck and separate deck options for further evaluation in a Phase 2 bridge screening.

## 6 Phase 1 Bridge Assessment: Bridge Types

### 6.1 Bridge Type Selection

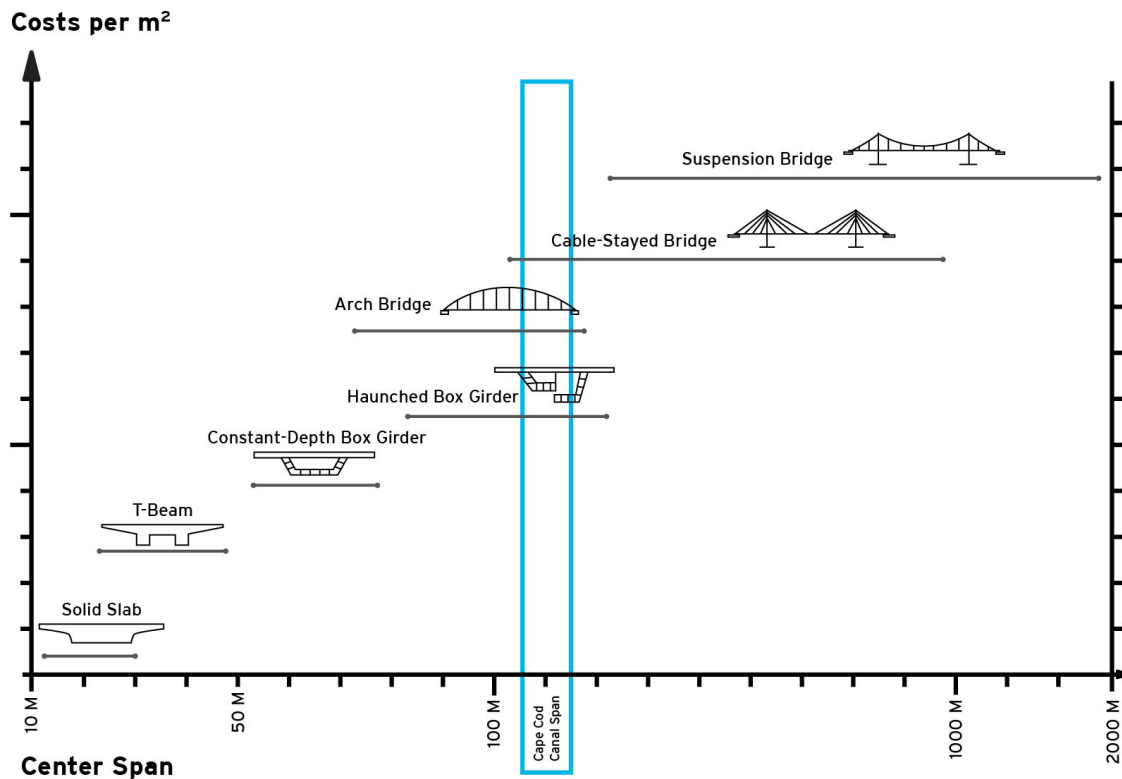
Incorporating the USACE's Preferred Alternative for In-Kind Bridge Replacements, and in collaboration with FHWA and USACE, MassDOT conducted initial screenings to identify feasible bridge types and configurations for further evaluation. For the initial assessments, a wide range of bridge types and design parameters were considered and screened, which allowed MassDOT to identify the decision drivers for bridge type selection, to advance favorable design features, and to eliminate unfavorable options.

As illustrated in Figure 6-1, mainline span length is a critical parameter that affects bridge type selection and bridge cost.<sup>8</sup> The vertical blue lines in Figure 6-1 indicate the possible bridge types appropriate for the full range of potential Cape Cod Canal mainline span crossings of 525 to 820 feet. Additionally, Figure 6-1 indicates that the unit cost per deck area increases with mainline span length. In general, for structural efficiency, the center span length should be limited to the minimum needed to meet functional and aesthetic requirements.

Considering the most cost-effective bridge types that would meet the applicable mainline center span range, MassDOT initially identified the tied-arch bridge, the box girder bridge, and the cable-stayed bridge as the most efficient structure bridge types and potential replacement bridge types for the Bourne and Sagamore highway bridges. A truss bridge type was also considered as potentially feasible. Because they would not be cost-effective, the suspension bridge type, the constant-depth box girder type, the T-Beam bridge type, and the solid slab bridge type were dismissed from further consideration.

---

<sup>8</sup> Adapted from Svensson, H., *Cable-Stayed Bridges – 40 Years of Experience Worldwide*, Ernst & Sohn, 2011.

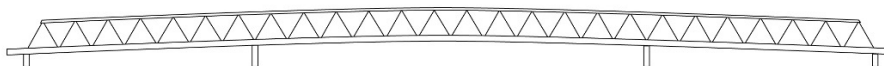


**Figure 6-1. Bridge Type by Cost and Span Length**

### 6.1.1 TRUSS BRIDGE

The existing Bourne and Sagamore highway bridges are steel truss bridges, with a truss arch span over the canal. Truss bridges are load-bearing structures composed of a series of interconnected triangles, known as trusses, providing a stable form that can support considerable loads over a large span.

For this option, MassDOT identified two variations consisting of a constant depth truss for span lengths up to approximately 700 feet and a variable depth truss for the long span of 820 feet. Figure 6-2 shows an elevation view schematic drawing of a constant depth truss bridge.



**Figure 6-2. Schematic of Truss Bridge Option**

In this option, substantial portion of a truss bridge would be “stick-built” in place, requiring temporary falsework (piers or high towers) in the canal during erection to support a structure until it becomes self-supporting. Alternatively, the center span could potentially be constructed in an off-site fabrication yard, transported to the site via an ocean-going barge, and lifted into place.

### 6.1.2 TIED-ARCH BRIDGE

In a tied-arch bridge, the arch is positioned above the bridge deck and attached cables support the deck. Traditional tied-arch bridges use vertical bridge piers with the arches located on top of the piers. As a variation, MassDOT also identified a tied-arch configuration on a Delta frame, where the approach spans cantilever into the main span, thereby shortening the length of the tied arch but adding some approach complexity with the Delta frame. Figures 6-3 and 6-4 show schematic drawings of a tied-arch bridge (non-Delta frame) and a tied-arch bridge with a Delta frame.

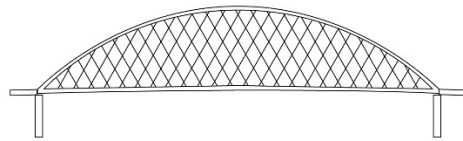


Figure 6-3. Schematic of Tied-Arch Bridge Option – Longer Arch (Non-Delta Frame)

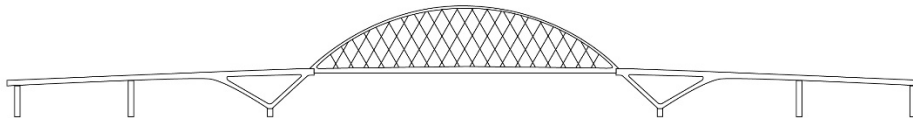
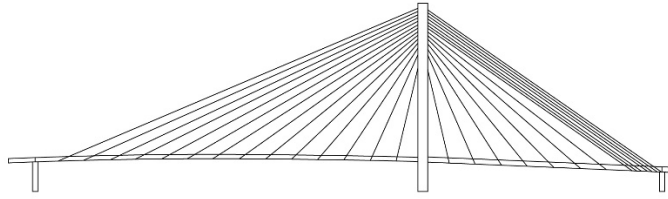


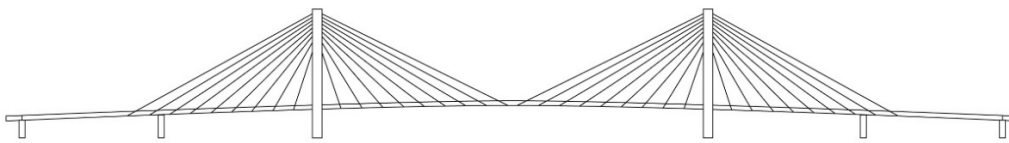
Figure 6-4. Schematic Of Tied-Arch Bridge Option – Delta Frame

### 6.1.3 CABLE-STAYED BRIDGE

In a cable-stayed bridge, the weight of the steel deck is supported by multiple diagonal cables in tension running directly to one or more towers. For the Cable-Stayed Bridge Option, MassDOT identified two configurations, with either a single tower or two towers. Of the two configurations, the single-tower results in the taller structure with a tower height above deck between 30 percent and 40 percent of the span length, or approximately 250 feet. Two-tower configurations tend to be more efficient, with tower heights in the range of 20 percent to 25 percent of the main span length, or approximately 154 feet. Figures 6-5 and 6-6 show schematic drawings of a Cable-Stayed Bridge Option with a single-tower and with two-towers.



**Figure 6-5. Schematic of Cable-Stayed Bridge Option – Single-Tower**



**Figure 6-6. Schematic of Cable-Stayed Bridge Option – Two-Towers**

A cable-stayed bridge would be constructed either from short, prefabricated elements delivered by barge or on-site using tower cranes. Erection of the cable-stayed bridge towers on-site would be as a balanced-cantilever erection, with the deck advanced symmetrically from each tower, or as a progressive cantilever construction, with the back span erected on shoring towers, followed by successive installation of shorter main span segments that cantilever over the canal span.

#### **6.1.4 BOX GIRDER BRIDGE**

In a box girder bridge, the deck is built on top of girders, rigid horizontal support beams, which are bound together in a hollow box shape. Supporting structures, such as cables, are not required above the deck level to support the bridge. MassDOT initially investigated variations for the Box Girder Bridge consisting of steel boxes or post-tensioned concrete boxes. However, because there is no recent experience in the United States for construction of a steel box variation in the proposed 700-foot or 820-foot mainline span lengths, MassDOT dismissed the steel box variation as a viable option and evaluated only the post-tensioned concrete box. Figure 6-7 shows a schematic drawing of the Concrete Box-Girder Bridge Option.



**Figure 6-7. Schematic of Concrete Box Girder Bridge Option**



A concrete box girder bridge would be constructed as balanced cantilevers with cast-in-place concrete placed into form travelers.

## 6.2 Bridge Type Screening Methodology

MassDOT performed a rigorous engineering analysis to produce qualitative-level screenings to evaluate the four bridge types according to the following bridge design evaluation criteria:

- Initial costs, consisting of a qualitative evaluation of costs of the main span superstructure and main span foundations (substructure), and approaches.
- Ability to meet or exceed highway geometric design standards, consisting of the following:
- Required highway elevation, and corresponding grade and length of the approach spans and ramps (horizontal tangent length), to meet the bridge's vertical clearance of 138 feet over the navigation channel, and
- Required tie-in of vehicular and pedestrian ramps to the highway bridge mainline.
- Constructability, including duration of construction, potential for phasing, difficulty, and impact on canal traffic.
- Structural redundancy of fracture-critical and failure-critical members.
- Inspection and maintenance requirements, including accessibility to bridge components, exposure to the elements, and frequency of required inspection and maintenance.
- Durability, consisting of protection, replacement, and monitoring of structure members.
- Response to adverse weather conditions, including snow, ice, and wind.
- Community considerations, including aesthetics.

MassDOT placed highest priority on bridge type options that would be practical and feasible to construct and maintain; bridge types that would not be practical and feasible were dismissed from further evaluation.

Additionally, MassDOT placed high priority on a bridge construction method that would minimize Cape Cod Canal navigation impacts. Cape Cod Canal supports substantial vessel traffic in both directions, such that barges, temporary construction supports (falsework), and/or any in-water equipment in the canal, both within and adjacent to the navigation channel, would be at risk for vessel impact. Long-term obstruction of the canal would amplify this risk. Based on consultation with the USACE, construction methods that would require falsework in the canal or frequent construction activities from the canal would be unacceptable. Short-term planned canal closures would be preferable over long-term operational restrictions in the channel.

MassDOT used an unscaled, qualitative rating scheme to facilitate the Phase 1 initial screening. Of particular importance are the triple-green (●●●) and triple-red (●●●) ratings, indicating options that MassDOT advanced to the next evaluation phase (Phase 2 secondary screening) or options that MassDOT removed from further consideration.

### 6.3 Bridge Type Phase 1 Screening Results

Tables 6-1 and 6-2 present the results of the initial screenings of bridge types with piers located out-of-water, with either an approximate 700-foot or 820-foot main span length.

Table 6-1. Summary of Bridge Phase 1 Screening - 700-Foot Main Span

Bridge Design Evaluation Criteria <sup>a</sup>	Truss	Tied Arch		Cable Stayed		Concrete Box Girder
		Without Delta Frame	With Delta Frame	Two-Tower	Single-Tower	
<b>Initial Costs</b>						
• Main Span Structure	●	●●	●●	●●	●●●	●●
• Main Span Foundation	●●	●●	●●	●●	●●	●●
• Overall	●●	●●	●●	●●	●●	●●
<b>Highway Geometrics</b>						
• Grade/Length	●●	●●	●●	●	●	●●
• Horizontal Tangent Length	●●	●●	●●	●●	●●	●●
<b>Construction</b>						
• Duration	●●	●●●	●●●	●	●●	●
• Constructability	●●	●●	●●●	●●	●	●
• Impact on Canal Traffic	●	●●●	●●●	●	●	●●●
<b>Structural Redundancy</b>						
• Fracture-Critical Members	●●●	●●	●●	●●	●●	●●●
• Failure-Critical Members	●●	●●	●●	●●	●●	●●
<b>Inspection &amp; Maintenance</b>						
• Access	●●	●●	●●	●	●	●●
• Frequency	●●	●	●	●	●	●●●
<b>Durability</b>						
• Protection	●	●	●	●	●	●●
• Replacement	●	●●	●●	●	●	●●
• Monitoring	●	●	●	●	●	●
<b>Wind Response</b>						
• Structural Efficiency	●●	●●	●●	●●	●●	●●
• Dynamic Effects	●	●	●	●●	●●	●●
<b>Snow &amp; Ice Response</b>						
• Bridge Closures	●	●	●	●●	●●	●●

Bridge Design Evaluation Criteria <sup>a</sup>	Truss	Tied Arch		Cable Stayed		Concrete Box Girder
		Without Delta Frame	With Delta Frame	Two-Tower	Single-Tower	
• Monitoring/Deicing	●	●	●	●●	●●	●●
<b>Community Considerations</b>						
• Aesthetics	●●	●●	●●	●●	●●	●●

a. ●●● Most favorable; ●● Favorable; ● Neutral; ●● Less Favorable; ●●● Unfavorable; ●● Not Rated

Table 6-2. Summary of Bridge Phase 1 Screening - 820-Foot Main Span

Bridge Design Evaluation Criteria <sup>a</sup>	Truss	Tied Arch		Cable Stayed		Concrete Box Girder
		Without Delta Frame	With Delta Frame	Two-Tower	Single-Tower	
<b>Initial Costs</b>						
• Main Span Structure	●●	●●	●●	●●	●●●	●
• Main Span Foundation	●●	●●	●●	●●	●●	●●
• Overall	●●	●●	●●	●●	●●	●●
<b>Highway Geometrics</b>						
• Grade/Length	●●	●●	●●	●	●	●●
• Horizontal Tangent Length	●●	●●	●●	●●	●●	●●
<b>Construction</b>						
• Duration	●●	●●●	●●●	●●	●●	●
• Constructability	●●	●●	●●●	●●	●	●
• Impact on Canal Traffic	●●	●●	●●	●	●	●●●
<b>Structural Redundancy</b>						
• Fracture-Critical Members	●●●	●●	●●	●●	●●	●●●
• Failure-Critical Members	●●	●●	●●	●●	●●	●●
<b>Inspection &amp; Maintenance</b>						
• Access	●●	●●	●●	●	●	●●
• Frequency	●●	●	●	●	●	●●●
<b>Durability</b>						
• Protection	●	●	●	●	●	●●
• Replacement	●	●●	●●	●	●	●●
• Monitoring	●	●	●	●	●	●
<b>Wind Response</b>						
• Structural Efficiency	●	●	●	●●	●	●
• Dynamic Effects	●	●●	●●	●●	●●	●●
<b>Snow &amp; Ice Response</b>						

Bridge Design Evaluation Criteria <sup>a</sup>	Truss	Tied Arch		Cable Stayed		Concrete Box Girder
		Without Delta Frame	With Delta Frame	Two-Tower	Single-Tower	
• Bridge Closures	●	●	●	●●	●●	●●
• Monitoring/Deicing	●	●	●	●●	●●	●●
<b>Community Considerations</b>						
• Aesthetics	●●	●●	●●	●●	●●	●●

a. ●●● Most favorable; ●● Favorable; ● Neutral; ●● Less Favorable; ●●● Unfavorable; ●● Not Rated

Based on their performance relative to the bridge design criteria, and incorporating either a single deck or two-deck configuration, MassDOT advanced the tied-arch bridge type, the cable-stayed bridge type, and the box girder bridge type for a secondary assessment in the following configurations:

- Tied-Arch Bridge Option, either with traditional piers (without Delta frame) supporting a 700-foot main span or with a Delta-frame configuration supporting a 700-foot or 820-foot main span;
- Two-Tower Cable-Stayed Bridge Option supporting a 700-foot or 820-foot main span; and
- Concrete Box Girder Bridge supporting a 700-foot main span.

The Phase 1 screening also identified specific Phase 2 analyses required to confirm the qualitative assessments presented in Tables 6-1 and 6-2. For example, MassDOT identified the need for wind tunnel studies to confirm verify the dynamic effects of the bridge options relative to wind force. Additionally, MassDOT identified an option to provide two separate bridge structures (barrels) at each crossing to facilitate phased construction.

Sections 6.3.1 and 6.3.2 discuss the major evaluation criteria differentiators shown in Tables 6-1 and 6-2, and MassDOT’s decisions to advance or dismiss bridge type options and their variations for a secondary evaluation.

### 6.3.1 BRIDGE TYPE OPTIONS ADVANCED FOR FURTHER EVALUATION

#### 6.3.1.1 Tied-Arch Bridge with Delta Frame, 700-foot, or 820-Foot Main Span; Tied- Arch Bridge without Delta Frame, 700-foot Main Span

*Initial Costs Rating: Favorable*

The Tied-Arch Bridge Option offers the potential for accelerated bridge construction, with the steel arch structure fabricated offsite while on-site foundation and substructure construction progress simultaneously. With off-site construction, the tied arch could be delivered by barge as a complete unit and lifted into position during a short, single (approximate 48-hour long) closure of the canal. This option also receives a favorable rating regarding initial costs of the main span structure.

*Geometrics Rating: Less Favorable to Favorable*

The Tied-Arch Bridge Option has the least main span girder depth, giving it a favorable highway geometrics rating regarding the required vertical grade and length of the approaches to meet the bridge. For both variations, only the design of the main span over the canal would need to be straight; the approach span design could accommodate highway design plan curvature, increasing flexibility for the approach highway networks.

*Construction Rating: Favorable to Most Favorable*

Due to the opportunity for accelerated bridge construction, with the steel arch structure fabricated offsite concurrent with on-site foundation and substructure construction, this option receives a most favorable rating regarding construction duration. Due to an anticipated short, scheduled canal closure for the tied arch installation, this option receives a most favorable rating regarding impact on canal operations. The Delta frame variation, with a shortened arch length, could be positioned between the piers in its low position, allowing for a relatively quick and stable lifting operation. Because it would avoid interference between arch and piers during the lifting operation, the Tied-Arch Bridge Option - Delta frame receives a most favorable constructability rating in comparison to a favorable rating for the Tied-Arch without Delta frame.

*Structural Redundancy Rating: Favorable*

In the Tied-Arch Bridge Option, the tie girders, hangers, and floor beams are designed for system redundancy for fracture-critical and failure-critical members. This option would use inclined cables arranged in a network pattern as opposed to the traditional vertical cable arrangement. The arch's closely spaced cables in a network pattern arrangement would provide structural redundancy and improved rib stability for these failure-critical members; the loss of one or several cables could be easily accommodated by the structure. Additionally, the tie girders and ribs would be accessible for inspection, maintenance, and replacement, resulting in a favorable rating.

**6.3.1.2 Two-Tower Cable-Stayed Bridge, 700-Foot, or 820-Foot Main Span**

*Initial Costs Rating: Favorable*

The two-tower supported Cable-Stayed Bridge Option, at the lower end of an efficient main span structure range for this type of bridge (as shown on Figure 6-1), receives a favorable rating.

*Geometrics Rating: Less Favorable to Neutral*

This option receives a less favorable rating regarding main and side spans and horizontal tangent length in both span lengths: neither the main span nor the side span design could accommodate any highway design plan curvature, reducing flexibility for the approach highway networks.

*Construction Rating: Favorable*

For this option, cantilever superstructure construction using prefabricated steel or concrete elements would have short-term impacts on canal traffic: navigation would be impacted by the periodic, partial obstructions of the canal for the approximate 40 segment lifts required for each bridge construction. A repetitive construction cycle could benefit the construction schedule.

*Structural Redundancy Rating: Favorable*

The crossing hanger cables and floor beams, determined to be fracture-critical members, would be designed for system redundancy; due to their close spacing, the loss of one or several cables could be accommodated by the overall structure.

*Wind, Snow, and Ice Rating: Less Favorable*

This option receives a less favorable rating with respect to adverse weather conditions, including response to wind, snow, and ice. Wind tunnel studies would be needed for further assessment.

**6.3.1.3 Concrete Box Girder Bridge, 700-foot Main Span**

*Initial Costs Rating: Less Favorable to Favorable*

Due to the simplicity of the structure, the Concrete Box Girder Bridge Option receives a favorable rating regarding the initial costs of the main span structure. However, the Box Girder Bridge Option would require a girder depth of 10 to 20 feet greater than that required for the other bridge types; the deeper substructure would require longer or steep approaches, resulting in higher main span foundation and overall costs and a less favorable rating.

*Geometrics Rating: Less Favorable to Favorable*

Due to the required main span girder depth, this option would require length or grade, resulting in a less favorable rating. However, this option could accommodate a moderate highway plan curvature, increasing flexibility for the approach highway networks.

*Construction Rating: Neutral to Most Favorable*

A post-tensioned concrete box variation would be constructed as balanced cantilevers with cast-in-place concrete placed into form travelers. This method would present the opportunity for accelerated construction by working from two piers simultaneously; due to the repetitive construction cycle, the concrete box variation receives a favorable constructability rating. Further, balanced cantilever construction would take place entirely from above and would not affect navigation, resulting in a most favorable rating regarding construction impacts to canal traffic.

*Structural Redundancy, Inspection and Maintenance Rating: Less Favorable to Most Favorable*

With no fracture-critical members and with the fewest elements to maintain and inspect, the Concrete Box Girder Option is rated most favorable regarding structural redundancy and frequency of inspection and maintenance in comparison with other bridge types. But due to the post-tensioning tendons, failure-critical members, this option receives a less favorable rating. In addition, deck replacement would not be possible in this option, should it be required in the future.

*Durability, Snow, and Ice Rating: Less Favorable to Favorable*

This option would not require supporting structures above the deck level. Unlike the other bridge type options, the Concrete Box Girder Bridge Option would have the fewest exposed and vulnerable elements and impacts due to adverse weather conditions would be uncommon or negligible.

**6.3.2 BRIDGE TYPE OPTIONS DISMISSED FROM FURTHER EVALUATION**

**6.3.2.1 Truss Bridge, 700-Foot, or 820-Foot Main Span**

*Construction Rating: Neutral to Less Favorable*

Constructing this option would be slower than the other options. Falsework for stick-building would reduce the horizontal clearance at the bridge site for the entire duration of superstructure construction.

Further, temporary fendering or other means of pier protection around the falsework during construction would introduce additional expense and complexity.

*Structural Redundancy Rating: Less Favorable to Unfavorable*

Tension elements in truss bridges, such as the tension diagonals and chords, are considered fracture-critical and any truss member is considered failure-critical. These members are subject to special fabrication and material quality and testing requirements: fracture-critical members must be inspected at arm's length every other year.

#### 6.3.2.2 Tied-Arch Bridge without Delta Frame, 820-Foot Main Span

*Initial Cost Rating: Less Favorable*

The longer arch of the Tied-Arch Bridge (without Delta frame) represents the upper end of the economical span range; as a result, it receives a lower cost rating.

*Construction Rating: Less Favorable to Unfavorable*

On-site stick building of this option would involve a long construction phase, resulting in an unfavorable construction duration. Additionally, the temporary falsework required during arch construction and erection would impact canal operations for approximately one year. Consultation with USACE as well as review of construction risks eliminated construction methods that that would require falsework or frequent construction activities in and from the canal from the canal.

#### 6.3.2.3 Single-Tower Cable Stayed Bridge, 700-Foot, and 820-Foot Main Span

*Initial Cost Rating: Unfavorable*

Although the Single-Tower Cable Stayed Bridge variation's rankings are like the two-tower variation, due to its inefficient structural system leading to substantially higher costs for the main span structure, the Single-Tower Cable Stayed Bridge structure receives unfavorable ratings in both the 700-foot and 820-foot mainline span length.

#### 6.3.2.4 Concrete Box Girder Bridge, 820-Foot Main Span

*Initial Cost Rating: Less Favorable to Neutral*

While this option would have an efficient and simple structural system, there would be higher overall costs due to the heavy foundation and deeper superstructure.

*Construction Rating: Neutral to Most Favorable*

Construction of this option would have no impact on canal operations, resulting in a most favorable rating. However, the current main span length record for a concrete box girder bridge in the United States is 760 feet; while construction of the 820-foot span may be feasible, it would not be practicable for the Program.

## 7 Phase 2 Bridge Assessment: Bridge Type Secondary Screening

Based on the results of the Phase 1 initial bridge type screenings, MassDOT determined that the following bridge types and configurations would be assessed in a Phase 2 secondary screening:

- Tied-Arch Bridge with Delta frame supporting a 700-foot main span on a single deck, or supporting a 700-foot or 820-foot main span on separate decks;

- Tied-Arch Bridge without Delta frame supporting a 700-foot main span on separate decks;
- Two-Tower Cable Stayed Bridge supporting a 700-foot or 820-foot main span on separate decks, or supporting an 820-foot main span on a single deck; and
- Concrete Box Girder Bridge supporting a 700-foot main span on separate decks.

In the Phase 2 secondary screening, MassDOT conducted additional highway geometrics assessments and performed a detailed and comprehensive constructability assessment of the bridge type options selected as feasible by the Phase 1 screening. The constructability assessments included further evaluations of bridge deck configuration and bridge fabrication and erection methodologies. MassDOT then presented the preliminary recommendations for the favorable and preferred bridge types to the public. The public’s review of MassDOT’s preliminary recommendations, including an assessment of community considerations and bridge aesthetics, confirmed the recommended bridge type to be advanced for further design.

## 7.1 Highway Geometrics Assessments

Highway and interchange conceptual design progress after completion of the Phase I screening report confirmed that there are feasible geometric solutions for bridges with structure depths in the 8-foot range, such as the Tied-Arch Bridge and Cable Stayed Bridge options.

The Tied-Arch Bridge with Delta Frame would have the least main span girder depth, which would facilitate the grade and length of the highway approach spans and ramps needed to accommodate the required vertical clearance of approximately 138 feet over the navigation channel. Additionally, this option would provide the flexibility to tie in interchange approach ramps closer to the main span. The Two-Tower Cable Stayed Bridge was shown to be feasible from a highway geometrics but would limit or eliminate some approach configurations and steepen ramp grades, resulting in a less favorable highway geometrics rating.

An analysis of ramp tie-in grades indicated that the deeper structure depth required for the Concrete Box Girder Bridge Option would not meet highway or ADA design criteria and codes. Further, this option would require an approach length and grade that could not be accommodated in highway design and construction without substantial right-of-way impacts.

## 7.2 Constructability Assessments

### 7.2.1 BRIDGE DECK CONFIGURATION

A constructability review of the project site and bridge configurations identified a bridge structure configuration with a single deck as a constructability risk. Single deck configurations would be at the limit of transportability, being erectable, and interim stability. Wide decks would necessitate large floor beams, require increased crane capacity, and enhance complexity of geometry control as rotation makes field connections difficult.

In contrast, a two-deck configuration would offer constructability and phasing benefits over single structures due to smaller member sizes, simplified geometry control, and ability to sequence



construction of new spans with demolition of existing spans. With separate bridge structure decks, the new bridge would be built parallel to the existing structure. It would then carry traffic in a temporary configuration, while the old bridge would be demolished, and a new second-phase bridge would be erected in its place.

Incorporating a twin deck configuration would provide flexibility during construction and, while potentially increasing total construction time, it also would accelerate the schedule for decommissioning of the existing bridges. An accelerated schedule for demolishing the existing bridges would be highly advantageous in view of the high cost of maintaining the existing bridges and considering the risk and high user cost of loss of service. For these reasons, MassDOT dismissed the single-deck configuration and advanced the bridge structure configuration with twin parallel decks.

### **7.2.2 BRIDGE FABRICATION AND ERECTION METHODOLOGIES**

As an alternative to in-situ piecewise erection (“stick building”), a traditional methodology for arch construction which relies on falsework to temporarily support arch members until the full span is complete, MassDOT investigated the potential to fabricate the replacement bridge arch span offline of the permanent alignment, then transport it to the final installed position. Due to existing site condition constraints, MassDOT determined that no suitable arch fabrication sites exist along canal, however offsite fabrication and open-water transport would be feasible. The constructability assessment indicated that for spans in the 700-foot range, twin Tied-arch Bridges on Delta piers lifted using strand jacks would be very well suited to site conditions; the vertical clearances of the existing Bourne and Sagamore bridges and barge operations favor the 700-foot span.

With a tied-arch bridge, the steel structure could be assembled in a remote fabrication yard, transported to the site on an ocean-going barge, and lifted into place. This construction scheme would minimize impact to canal traffic, requiring a short closure only during the lifting operation. With a Tied-Arch Bridge, the arch would be self-supporting and stable for transport once constructed on land and transferred to a barge for transport. In contrast to a cable-stayed bridge erection, float-in construction of a tied-arch bridge would enable the structure to be installed as a complete, stable unit. Duration of the critical lifting operation would be minimal and could be scheduled to take advantage of favorable weather conditions.

Positioning the longer arch (non-Delta frame) into place would require lifting the arch approximately 140 feet from a barge in an off-line position to avoid the vertical piers. This construction requirement would be risky from a practicality, schedule, and cost perspective, resulting in an unfavorable construction rating. The shorter arch of the Delta frame, as opposed to the longer span of the non-Delta variation, would be beneficial regarding barge size and the limited vertical clearance of the existing bridges. Further, the tied-arch bridge on delta piers would be preferred over straight piers (non-Delta variation), as the simplified lifting operations would avoid the challenge of maintaining barge stability while lifting the arch to the elevation required for installation on straight piers. The Tied-Arch Bridge with Delta frame supporting a 700-foot main span receives most favorable construction ratings for duration of construction and constructability.

Over the past decade, sustained wind speeds of 20 miles per hour (mph) or greater have been recorded on approximately 10 percent of days during the winter months (October through April). Gusts exceeding 40 mph occur regularly. Extreme weather and/or wind events can be expected to occur during construction while the structure is in a vulnerable state. To mitigate the risk associated with extreme weather or wind events, MassDOT determined that a design and erection strategy which minimizes the time the structure is vulnerable during erection would be preferred.

While twin cable stayed bridge configurations in the 820-foot range would be well suited to the site conditions the Cable-Stayed Bridge Option in both the 700-foot and 820-foot span length would be vulnerable to high winds events during construction relative to tied arch bridges on delta piers. Erection of cable-stayed bridge towers requires the use of tower cranes. Wind tunnel testing of the Cable-Stayed Bridge option indicates that the use of tower cranes would be subject to severe operational restrictions in windy conditions, whether they are operated from land or a barge, or if they are tower-based. Tower cranes generally have a safe operational wind ceiling of 25 mph. Given the exposed site, this limitation would present a considerable construction schedule risk. Wind tunnel testing indicates that the cable-stayed bridge type would be vulnerable to wind loads during certain construction stages and cable-stayed construction operations would be more affected by high-wind conditions. The cables would be vulnerable to wind and wind-rain induced vibrations, and the light structure itself would be more susceptible to dynamic effects. The cable force and geometry control requirements would present considerable schedule and cost risks.

### 7.3 Public Review of Preliminary Recommendations

In November 2022, MassDOT conducted virtual public meetings to review preliminary recommendations of the feasible bridge types, obtain public sentiment on the options, and confirm the bridge type to be advanced for further design.

#### 7.3.1 COMMUNITY CONSIDERATIONS AND BRIDGE AESTHETICS

MassDOT reviewed three feasible bridge types relative to community considerations, including consistency with the Context Sensitive Design principal to be “in harmony with the community” and preserve the scenic, aesthetic, historic, and built resources of the area.

Figures 7-1 and 7-2 show renderings of the existing bridges from the viewpoints of the Cape Cod Canal and the motor vehicle driver crossing the bridge.<sup>9</sup> The arched main span, which is visually consistent with the surrounding terrain, emphasizes the crossing of the canal. While the initial construction of the Cape Cod Canal dates to 1916, the current bridges were constructed in 1935 in the same period as the USACE’s reconstruction of the canal throughout the 1930s. The existing Bourne and Sagamore bridges are contributing resources to and consistent with the character of the Cape Cod Canal Historic District, which was determined by the Massachusetts Historical Commission (MHC) to be eligible for individual listing in the National Register of Historic Places (NRHP). The bridges are recognized as the “Gateway to Cape Cod.” The Bourne Comprehensive Plan cites the importance that the bridge replacements “respect

---

<sup>9</sup> The singular rendering represents views from either the Bourne or Sagamore Bridge. As steel truss bridges with concrete column piers and abutments, the bridges are almost identical.

the iconic natures of these bridges to the Cape’s image,” noting that the bridges are integral to the local heritage of Cape Cod. The Cape Cod Commission’s Regional Policy Plan includes two policy goals applicable to the existing bridges and their replacements: Community Design, to “protect and enhance the unique character of the region’s built and natural environment based on the local context;” and Cultural Heritage, to “protect and preserve the significant cultural, historic, and archaeological values and resources of Cape Cod.” Further, the Policy Plan’s vision for Historic Areas, including local and/or NRHP districts, is to protect historic resources and to support development that respects the form, scale, and character of existing historic areas.

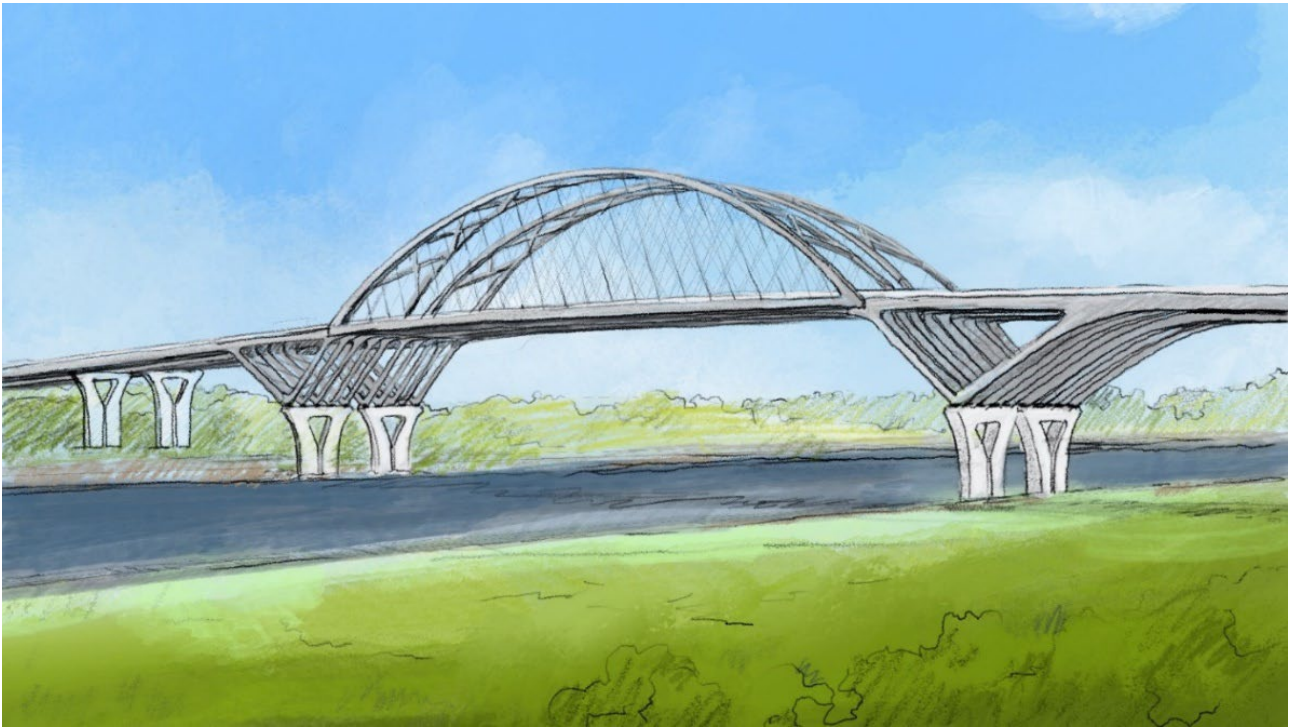


**Figure 7-1. Rendering of Existing Bridge – Cape Cod Canal Viewpoint**



**Figure 7-2. Rendering of Existing Bridge – Driver Viewpoint**

Figures 7-3 and 7-4 show renderings of the Tied-Arch Bridge Option with Delta frame from the viewpoints of the Cape Cod Canal and the motor vehicle driver crossing the bridge. The Tied-Arch Bridge Option provides an iconic portal, like the existing bridges, and is consistent with the surrounding terrain. Because it would echo the appearance of the existing Bourne and Sagamore bridges and it provides a continuity of style and aesthetic, the Delta frame variation maintains a consistent visual linkage with the NRHP-eligible Cape Cod Canal Historic District. MassDOT determined that it is likely that the Tied-Arch Bridge Option - Delta frame would avoid an adverse visual effect on the NRHP-potentially eligible Cape Cod Canal Historic District.



**Figure 7-3. Rendering of Tied Arch Bridge with Delta Frame – Cape Cod Canal Viewpoint**



**Figure 7-4. Rendering of Tied Arch Bridge with Delta Frame – Driver Viewpoint**

Figures 7-5 and 7-6 show renderings of the Two-Tower Cable Stayed Bridge Option from the viewpoints of the Cape Cod Canal and the motor vehicle driver crossing the bridge. The bridge form represents a substantial departure from the visual character of the existing structure. Due to its dissimilarity to the existing historic structures, the introduction of modern element in its viewshed, and the inconsistency with the existing context, the Two-Tower Cable-Stayed Bridge Option potentially could have an adverse visual effect on the NRHP-potentially eligible Cape Cod Canal Historic District.



**Figure 7-5. Rendering of Two-Tower Cable Stayed Bridge – Cape Cod Canal Viewpoint**



**Figure 7-6. Rendering Of Two-Tower Cable Stayed Bridge – Driver Viewpoint**

Figures 7-7 and 7-8 show renderings of the Concrete Box Girder Bridge from the viewpoints of the Cape Cod Canal and the motor vehicle driver crossing the bridge. This option does not provide a gateway experience for the driver, and the massive concrete structure represents a departure from the gracefulness of the existing steel bridges. Due to its dissimilarity to the existing historic structures, the introduction of a modern element in its viewshed, and the inconsistency with the existing context, the Box Girder Bridge Option potentially could have an adverse visual effect on the NRHP- eligible Cape Cod Canal Historic District.



**Figure 7-7. Rendering of Concrete Box Girder Bridge – Cape Cod Canal Viewpoint**



**Figure 7-8. Rendering Of Concrete Box Girder Bridge – Driver Viewpoint**

### **7.3.2 PUBLIC POLLING RESULTS**

MassDOT received a total of 2,214 responses during and following the November 2022 public meetings. Tables 7-1 and 7-2 present the results of the public opinion polls. As shown in Table 7-2, with an average



rating of 4.5 out of 5, the Tied-Arch Bridge with Delta Frame received the most favorable public review rating.

Table 7-1. Public Review: Bridge Replacement Considerations

Polling Questions/Rankings	How important is that the new Cape Cod Bridges resemble the current Bourne and Sagamore Bridges?		The existing bridges are iconic as portals into Cape Cod. How important is it to replace the existing bridges with landmark structures?	
	Count	Percentage	Count	Percentage
Very Important	882	40	1,245	56
Somewhat Important	700	32	653	30
Not that Important	366	16	210	9
Not at all Important	263	12	100	5
<b>Total Responses</b>	<b>2,211</b>	<b>100</b>	<b>2,208</b>	<b>100</b>

Note: Percentages are rounded.

Table 7-2. Public Review: Bridge Type Options

Rate the Bridge Type According to Your Preference *	Tied Arch Bridge with Delta Frame		Two-Tower Cable-Stayed Bridge		Concrete Box Girder Bridge	
	Count	Percentage	Count	Percentage	Count	Percentage
★	64	2.9	510	23.0	1,479	66.8
★★	52	2.4	307	13.9	278	12.6
★★★	209	9.4	608	27.5	250	11.3
★★★★	328	14.8	416	18.8	100	4.5
★★★★★	1,561	70.5	373	16.8	107	4.8
<b>Total Responses</b>	<b>2,214</b>	<b>100.0</b>	<b>2,214</b>	<b>100.0</b>	<b>2,214</b>	<b>100.0</b>
<b>Average Rating</b>	<b>4.5</b>		<b>2.9</b>		<b>1.7</b>	
<b>★= least preferred; ★★★★★= most preferred</b>						

## 7.4 Bridge Type Phase 2 Screening Results

Tables 7-3 and 7-4 present the Phase 2 screening results of the three bridge types. The Phase 2 screening results incorporate MassDOT’s additional constructability assessments of the feasible bridge types and the public’s review of the feasible bridge types relative to community considerations and bridge aesthetics.

The Tied-Arch Bridge with Delta Frame supporting an approximate 700-foot mainline span received four favorable or more ratings out of six engineering criteria further evaluated during the Phase 2 screening. Additionally, the Tied-Arch Bridge with Delta Frame on a 700-foot mainline span received the highest public review rating.

Table 7-3. Summary of Bridge Phase 2 Screening - 700-Foot Mainline Span Length

<b>Bridge Design Evaluation Criteria <sup>a</sup></b>	<b>Tied-Arch Bridge</b>		<b>Two-Tower Cable Stayed Bridge</b>	<b>Concrete Box Girder Bridge</b>
	<b>Without Delta Frame</b>	<b>With Delta Frame</b>		
<b>Highway Geometrics</b>				
• Grade/Length	●●	●●	●●	●●●
• Horizontal Tangent Length	●●	●●●	●●	●●
<b>Construction</b>				
• Duration	●●●	●●●	●●	●
• Constructability	●●●	●●●	●●	●●
<b>Wind Response</b>				
• Structural Efficiency	●●	●●	●●	●●
• Dynamic Effects	●	●	●●	●●
<b>Community Considerations <sup>b</sup></b>				
• Aesthetics/Signature	●●	★★★★☆	●●	★★

a. ●●● Most favorable; ●● Favorable; ● Neutral; ●● Less Favorable; ●●● Unfavorable; ●● Not Rated

b. ★★★★★ = 4.5 stars, ★★★ = 2.9, ★★ = 1.7

Table 7-4. Summary Of Bridge Phase 2 Screening - 820-Foot Mainline Span Length

<b>Bridge Design Evaluation Criteria <sup>a</sup></b>	<b>Tied-Arch Bridge with Delta Frame</b>	<b>Two-Tower Cable Stayed Bridge</b>
<b>Highway Geometrics</b>		
• Grade/Length	●●	●●
• Horizontal Tangent Length	●●	●●
<b>Construction</b>		
• Duration	●●●	●●
• Constructability	●●●	●●
<b>Wind Response</b>		
• Structural Efficiency	●	●●
• Dynamic Effects	●●	●●
<b>Community Considerations <sup>b</sup></b>		
• Aesthetics/Signature	●●	★★★★

a. ●●● Most favorable; ●● Favorable; ● Neutral; ●● Less Favorable;

●●● Unfavorable; ●● Not Rated

b. ★★★★★ = 4.5 stars, ★★★ = 2.9 stars, ★★ = 1.7

As a result of the Phase 2 screening, MassDOT determined that the following bridge type will be advanced for further design of the Bourne and Sagamore replacement highway bridges: parallel, twin tied-arch bridge structures supported on Delta frames with an approximate 700-foot mainline span length. As design advances, MassDOT will determine exact span length, arch rib configuration, tie-in with approach ramps, and other parameters for the Tied-Arch Bridge with Delta Frame, which will be included in the Program Bridge Type Study.

## 8 Mainline Alignment Location Assessment

### 8.1 Mainline Alignment Location Options

Utilizing the USACE's MRER/EA Preferred Alternative of In-Kind Bridge Replacement, and in coordination with FHWA and USACE, MassDOT developed five optional configurations for each highway bridge mainline alignment location over Cape Cod Canal. Section 8 presents an evaluation of the Bourne and Sagamore highway bridge replacement mainline alignment location options, consisting of Fully Offline Inboard, Partially Offline Inboard, Partially Offline Outboard, Fully Offline Outboard and Split, and defined as follows:

- Fully Offline, where both barrels of the replacement highway bridge are located outside the footprint of the existing bridge.
- Partially Offline, where portions of the replacement highway bridge are located within the footprint of the existing bridge and portions of the replacement highway bridge are located outside the footprint of the existing bridge.
- Inboard, where the replacement highway bridge is located on the side of the canal between the existing Bourne Bridge and Sagamore Bridge. For Bourne, the replacement bridge would be east of the existing bridge closer to Cape Cod Bay. For Sagamore, the replacement bridge would be west of the existing bridge closer to Buzzards Bay.
- Outboard, where the replacement highway bridge is located on the bay side of the existing bridge. For Bourne, the replacement bridge would be west of the existing bridge closer to Buzzards Bay. For Sagamore, the replacement bridge would be east of the existing bridge closer to Cape Cod Bay.
- Split, where the traffic heading on-Cape would be located on one side of the existing bridge and the traffic heading off-Cape would be located on the other side of the existing bridge.

Except for the Split Option, the barrels of the replacement bridges would be constructed parallel to and approximately 10-feet apart from each other.

### 8.2 Mainline Alignment Screening Methodology

MassDOT established the following Program design criteria to evaluate the five optional configurations for the highway bridge mainline alignment location, based on preliminary design:

- Operations - Improve existing traffic operations.
- Connectivity - Maintain or improve existing roadway connections.

- Geometrics - Meet or exceed current MassDOT and FHWA design standards, without design exceptions, including but not limited to mainline curve lengths, stopping sight distances, and grade profiles for connecting to the interchange approach networks.
- Safety - Improve safety conditions by reducing predicted crash frequency, crash rate, crash type, and/or crash severity.
- Constructability - Maximize constructability and construction efficiency, including maintaining two traffic lanes in each direction at each crossing during construction, maintaining all connections to the local roadway network at locations like the existing condition during construction, maintaining and/or improving schedule and costs, minimizing impacts to the traveling public, and reducing complexity relative to staging and need for temporary structures.
- Multi-Modal Connections - Provide for multi-modal uses through separated bicycle and pedestrian accommodations on the bridge structure and to the interchange approach network.
- Utility Impacts – Minimize direct and indirect impacts to existing utilities within the footprints of the existing and/or replacement bridges, including relocations.
- Environmental Impacts- Minimize impacts to protected resources.
- Right-of-Way Impacts - Minimize impacts to properties, including full acquisitions and partial impacts, potential displacement, and adverse effects to Environmental Justice (EJ) communities.

Options were rated based on their performance relative to meeting the Program design evaluation criteria; the ratings of each option were then compared to identify the preferred option. MassDOT placed high priority on highway bridge mainline alignment location options that would be practical and feasible to construct and maintain; options that would not be practical and feasible were dismissed from further evaluation. MassDOT used an unscaled, qualitative rating scheme to facilitate the screening. Of particular importance are the triple-green (●●●) ratings and triple-red (●●●) ratings, indicating options that MassDOT will advance for further design or options that MassDOT removed from further consideration.

### 8.3 Bourne Bridge Mainline Alignment Location Screening Results

Table 8-1 presents the screening results of the Bourne Bridge mainline alignment location options and determination of the favorable option. The most favorable mainline location option for replacement of the Bourne Bridge was determined to be the Fully Offline Inboard Option, where both barrels of the replacement highway bridge would be located outside the footprint of the existing bridge, approximately 10 feet apart and parallel to each other, on the side of the canal between Bourne Bridge and Sagamore Bridge. The replacement structures for the Bourne Bridge would be east of the existing bridge, closer to Cape Cod Bay.

Table 8-1. Screening Results of Bourne Bridge Mainline Alignment Location Options

Highway Design Evaluation Criteria (1), (2)	Fully Offline Inboard Option	Partially Offline Inboard Option	Partially Offline Outboard Option	Fully Offline Outboard Option	Split Option
Operations	●●	●●	●●	●●	●●
Connectivity	●	●	●	●	●
Geometrics	●●●	●●●	●●●	●●●	●●●
Safety	●●	●●	●●	●●	●●
Constructability	●●●	●●	●●	●	●
Multi-Modal	●●	●●	●●	●●	●●
Utilities	●	●	●	●●	●
Environmental	■ ■	■ ■	■ ■	■ ■	■ ■
Right-of-Way	■ ■ ■ ■	■ ■ ■	■	■ ■	■ ■

(1) ●●● Most favorable; ●● Favorable; ● Neutral; ●● Less Favorable; ●● Unfavorable; ●● Not Rated  
 (2) Range of Least to Less Impacts= ■ ■ ■ ■, ■ ■ ■, ■ ■, ■; Medium Impacts= ◆; Range of More to Most Impacts= ■ ■ ■, ■ ■ ■, ■ ■ ■, ■ ■ ■

Among the five options for the Bourne Bridge mainline alignment location, performance would be generally consistent regarding traffic operations, connectivity, geometrics, safety, and multi-modal connections. Additionally, impacts to existing utilities and the environment would be similar among the options.

*Operations Rating: Favorable*

The inclusion of auxiliary lanes in all options would improve traffic operations relative to existing conditions, including traffic merging/diverging and weaving.

*Connectivity Rating: Neutral*

All options would maintain the four existing roadway connections.

*Geometrics Rating: Most Favorable*

All options would meet current MassDOT and FHWA design standards without design exceptions.<sup>10</sup> In all options, geometric improvements to the vertical profile curves would improve stopping sight distances.

*Safety Rating: Favorable*

With the addition of acceleration and deceleration lanes, increased lane widths, increased shoulder widths, geometric improvements to the vertical profile curves, and addition of a median barrier, safety conditions would improve in all options, resulting in a reduction in predicted crashes and a favorable safety rating.

*Multi-Modal Connections Rating: Favorable*

All options would include a separated pedestrian and bicycle shared use path in the final condition and a sidewalk in the construction phase. Additionally, all options would provide the same level of regional and local connections to the shared use path.

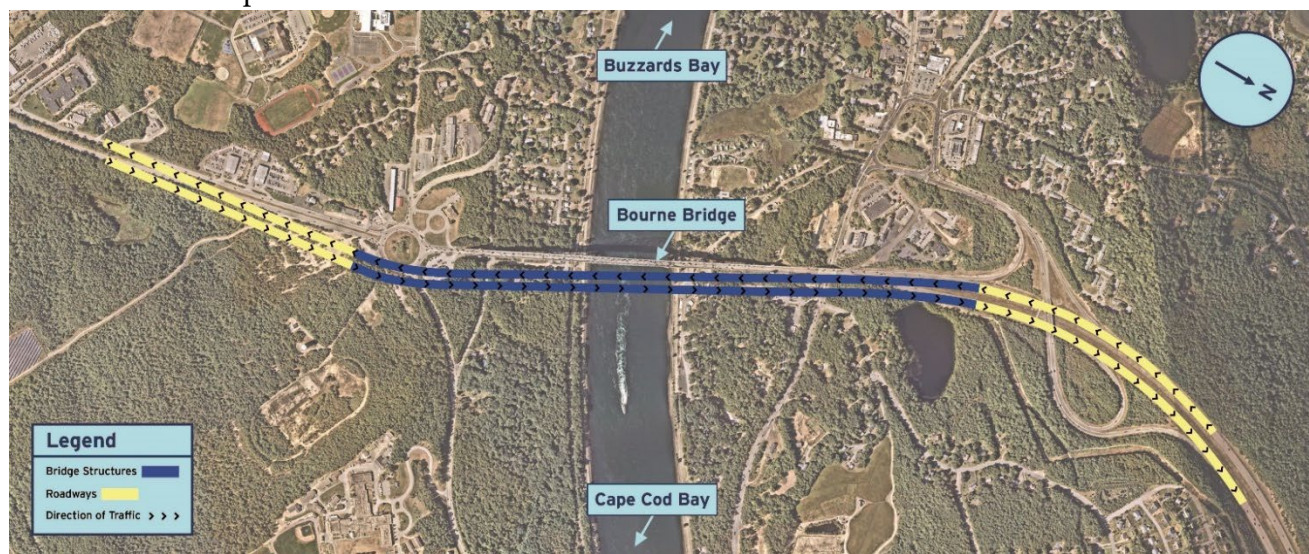
<sup>10</sup> Design standards include AASHTO’s 2018 “Policy on Geometric Design of Highways and Streets” Manual (Green Book) and MassDOT’s 2006 Project Development and Design Guide.

*Environmental Impacts Rating: Less Impactful*

Due to the replacement of the existing bridge, all options would result in an adverse effect to the NRHP-eligible Bourne Bridge under Section 106 of the NHPA. No direct impacts to Massachusetts Wetlands Protection Act (WPA)-protected resources are anticipated with any of the options. However, in all options, the ramp connections would be within the 100-foot buffer zone of Nightingale Pond. Sections 8.3.1 and 8.3.2 discuss the major evaluation criteria of constructability, utility impacts and right-of-way impacts that are differentiators, as shown in Table 8-1, and present MassDOT’s decisions to advance or dismiss the Bourne Bridge mainline alignment location options for further design.<sup>11</sup>

**8.3.1 OPTION ADVANCED FOR FURTHER EVALUATION: FULLY OFFLINE INBOARD**

In this option, both barrels of the replacement highway bridge would be located east of and outside the footprint of the existing Bourne Bridge, closer to Cape Cod Bay. Figure 8-1 shows a sketch of the Fully Offline Inboard Option.



**Figure 8-1. Bourne Bridge Fully Offline Inboard Option**

*Constructability Rating: Most Favorable*

In this option, MassDOT would be able to construct the new southbound bridge structure and the new northbound bridge structure without impacting the existing Bourne Bridge. In this option, the mainline would be located far enough to the east so that there would be no overlap with the existing Bourne Bridge and there would be available space for work zones at construction start. With full offline construction, this option would provide for the largest construction laydown area east of existing Bourne Bridge which would facilitate construction of both barrels of the replacement bridge. The first replacement barrel could be constructed away from the Bourne Rotary, which would facilitate construction staging more easily. Further, this option would maintain existing traffic flows and would minimally impact existing traffic patterns. All existing traffic could be relocated from the existing bridge

<sup>11</sup> Note that additional right-of-way impacts would occur when the favorable Bourne mainline location option is paired with the interchange approach options, as presented in Section 9.

to the first replacement bridge structure, thereby lessening the risk that major repairs and/or rehabilitation of the existing bridges would need to be performed.

*Utility Impacts Rating: Neutral*

This option would directly impact the Enbridge Gas Metering Station and would encroach on the gas transmission easement. This option would result in multiple minor impacts to water, sewer, telecommunications (cable television/fiber optics), and electric utilities, as well as multiple drainage system impacts.

*Right-of-Way Impacts: Least Impactful*

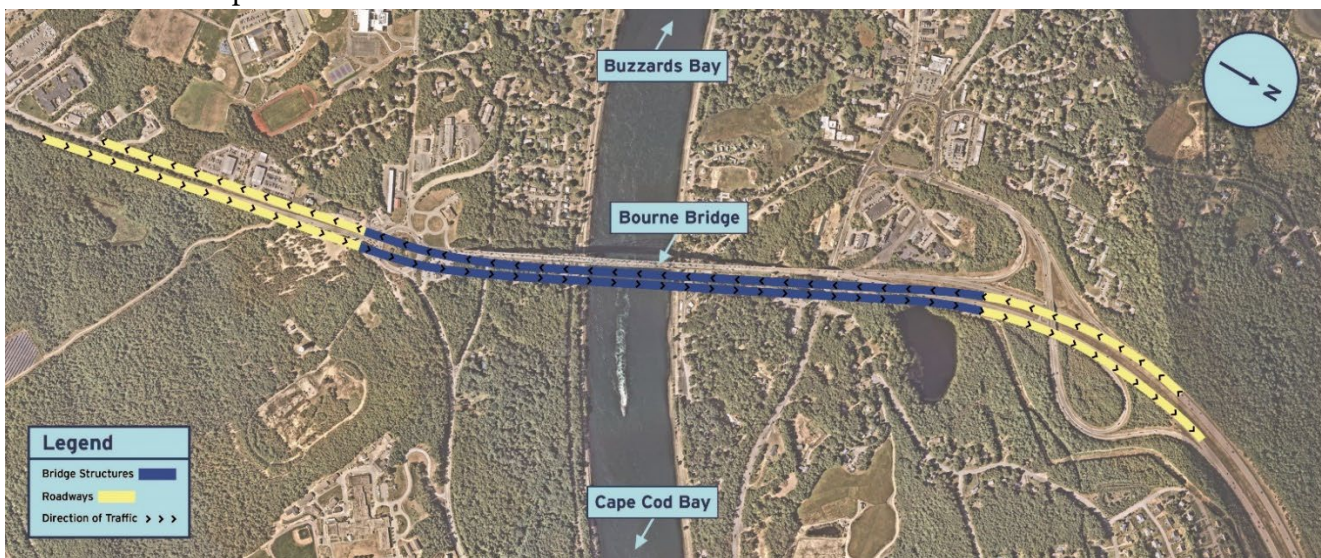
Based upon preliminary design, the Fully Offline Inboard Option would have the least impactful right-of-way impacts compared to other options. This option would result in one residential partial property impact, two commercial partial property impacts and five commercial full property acquisitions, consisting of an active business and four vacant parcels zoned for commercial use. None of the impacts would directly affect Environmental Justice (EJ) communities or populations.

Construction of the Fully Offline Inboard Option would impact Bourne Scenic Park, which is located on USACE property leased to the Bourne Recreation Authority and on Town of Bourne property. Impacts to USACE property would consist of approximately 333,000 square feet (sf) of permanent impacts and approximately 744,000 sf of construction impacts. Impacts to the Town of Bourne property would consist of approximately 118,000 sf of construction impacts. In the final condition, the land would be restored to park use. In addition to park impacts, this option could require infrastructure relocation at Bourne Scenic Park.

### 8.3.2 OPTIONS DISMISSED FROM FURTHER EVALUATION

#### 8.3.2.1 Partially Offline Inboard

In this option, the replacement highway bridge would be located east of and partially within the footprint of the existing Bourne Bridge, toward Cape Cod Bay. Figure 8-2 shows a sketch of the Partially Offline Inboard Option.



**Figure 8-2. Bourne Bridge Partially Offline Inboard Option**

*Constructability Rating: Less Favorable*

In this option, the northbound barrel would be much closer to existing traffic on the Bourne Bridge; this condition would force demolition of the existing Bourne Bridge prior to beginning construction of the replacement southbound barrel. While the existing ramp connections could potentially be maintained in this option, this construction sequencing would extend the construction schedule by at least one year in comparison to the Fully Offline Inboard Option. There would be additional difficulties in maintaining ramp access to the mainline, involving complex construction staging with more stages, including requiring temporary structures. The multiple traffic pattern changes of the Partially Offline Inboard Option would disrupt the existing flow of traffic. Additionally, this option would require construction over the active Bourne Rotary, resulting in extensive access issues to existing businesses south of the rotary. Further, there would be constrained laydown areas in the Partially Offline Inboard Option, creating mobilization inefficiencies for the contractor.

*Utility Impacts Rating: Neutral*

This option would directly impact the Enbridge Gas Metering Station and would encroach on the gas transmission easement. This option would result in multiple minor impacts to water, sewer, telecommunication, and electric utilities, as well as multiple drainage system impacts.

*Right-of-Way Impacts Rating: Less Impactful*

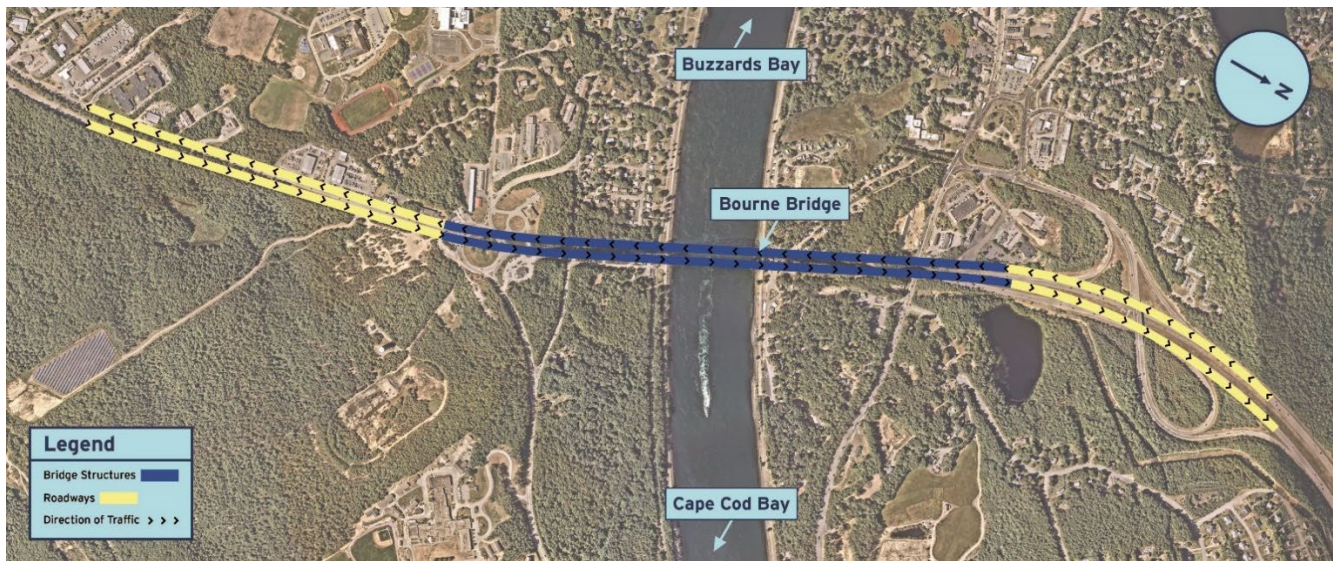
Based on preliminary design, this option would result in five commercial partial property impacts and two commercial full property acquisitions consisting of two active businesses. The impacts would not directly affect EJ communities or populations.

Construction of this option would impact Bourne Scenic Park. Impacts to USACE property would consist of approximately 329,500 sf of permanent impacts and approximately 667,000 sf of construction impacts. Impacts to the Town of Bourne property would consist of approximately 68,200 sf of construction impacts.

**8.3.2.2 Partially Offline Outboard**

In this option, the replacement highway bridge would be located west of and partially within the footprint of the existing Bourne Bridge, toward Buzzards Bay. Figure 8-3 shows a sketch of the Partially Offline Outboard Option.





**Figure 8-3. Bourne Bridge Partially Offline Outboard Option**

*Constructability Rating: Less Favorable*

In this option, demolition of the existing bridge would be required prior to beginning construction of the replacement northbound barrel. As a result, the construction schedule for the Partially Offline Outboard Option would be extended by at least one year in comparison to the Fully Offline Inboard Option. This option would involve complex construction staging with more stages, including requiring temporary structures. The multiple traffic pattern changes of the Partially Offline Outboard Option would disrupt the existing flow of traffic. Additionally, this option would result in extensive access issues to existing businesses south of the rotary and would require construction over the active Bourne Rotary. Further, there would be constrained laydown areas in the Partially Offline Outboard Option, creating mobilization inefficiencies.

*Utility Impacts Rating: Neutral*

This option would indirectly impact the Enbridge Gas Metering Station. The bridge would not be directly over the metering station; however, the metering station would still need to be relocated for the construction of the new bridge. This option would result in multiple minor impacts to water, sewer, telecommunication, and electric utilities. Additionally, due to conflicts with the proposed main span bridge piers and abutments, this option would involve multiple drainage system impacts, including relocation of the twin 43-inch by 68-inch elliptical outfall pipes, as well as portions of the connecting upstream Route 28 drainage.

*Right-of-Way Impacts Rating: Less Impactful*

Based on preliminary design, this option would result in one residential partial property impact, one residential full property acquisition, six commercial partial property impacts, and seven commercial full property acquisitions consisting of five active businesses, including a new 180,000 sf commercial development and a vacant building for three businesses. Additionally, this option would displace the

existing shopping plaza and the Massachusetts State Police Barracks, a community resource. The impacts would not directly affect EJ communities or populations.

Like the Fully Offline Inboard Option, this option would impact Bourne Scenic Park. Impacts to USACE property would consist of approximately 318,500 sf of permanent impacts and approximately 660,000 sf of construction impacts. Impacts to the Town of Bourne property would consist of approximately 5,000 sf of construction impacts.

Compared to the Fully Offline Inboard and Partially Offline Inboard options, the right-of-way impacts of the Partially Offline Outboard Option would be less impactful.

### 8.3.2.3 Fully Offline Outboard

In this option, both barrels of the replacement highway bridge would be located west of and outside the footprint of the existing Bourne Bridge, closer to Buzzards Bay. Figure 8-4 shows a sketch of the Fully Offline Outboard Option.



**Figure 8-4. Bourne Bridge Fully Offline Outboard Option**

#### *Constructability Rating: Neutral*

The Fully Offline Outboard Option would involve construction of the southbound barrel first, which would maintain existing ramp connections. Due to constrained right-of-way availability on the west side of the existing highway bridge, this option would have limited construction laydown areas, resulting in complex construction staging with more stages. The multiple traffic pattern changes of the Fully Offline Outboard Option would disrupt the existing flow of traffic. Like the Partially Offline Inboard and Partially Offline Outboard options, construction impacts of this option would include extensive access issues to existing businesses north and south of the Bourne Rotary.

#### *Utility Impacts Rating: Favorable*

Because it would not directly impact the Enbridge Gas Metering Station, early relocation of the gas line would not be critical in this option. This option would result in multiple minor impacts to water, sewer,

telecommunication, and electric utilities. Additionally, due to conflicts with the proposed main span bridge piers and abutments, this option would involve multiple drainage system impacts, including relocation of the twin 43-inch by 68-inch elliptical outfall pipes, as well as portions of the connecting upstream Route 28 drainage system.

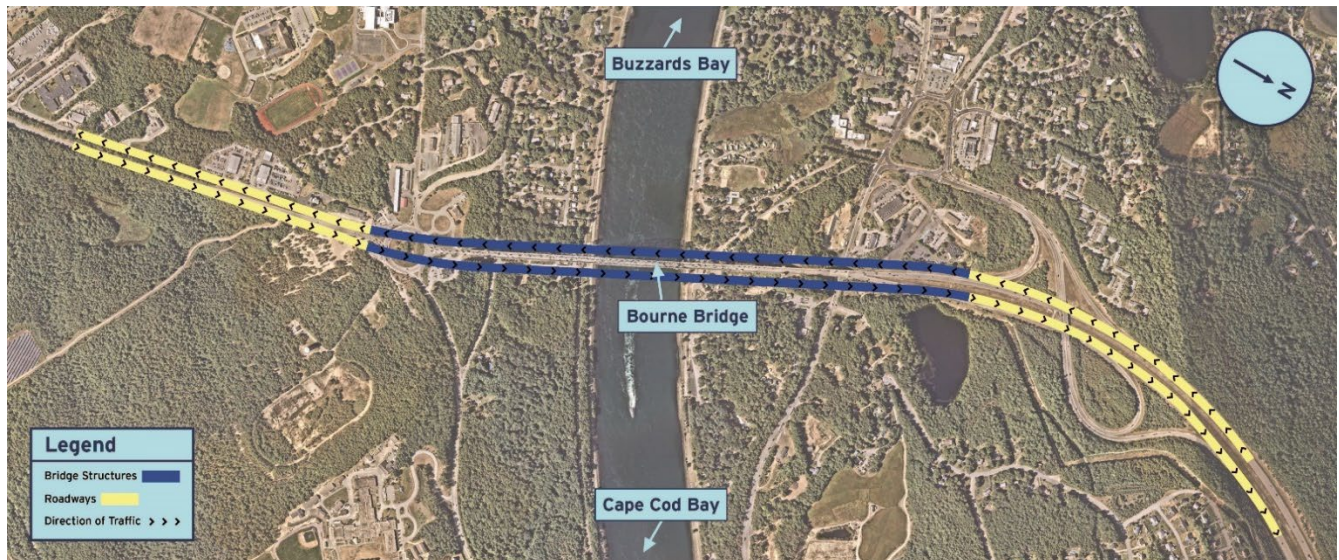
*Right-of-Way Impacts Rating: More Impactful*

Based on preliminary design, this option would result in three residential partial property impacts, three residential full property acquisitions, three commercial partial property impacts, and 11 commercial full property acquisitions consisting of 11 active businesses, including three gas stations, two motels, six businesses, and a vacant building for three businesses. Additionally, this option would displace the existing shopping plaza and the State Police Barracks. The impacts would not directly affect EJ communities or populations.

This option would impact Bourne Scenic Park. Impacts to USACE property would consist of approximately 320,000 sf of permanent impacts and approximately 674,000 sf of construction impacts. The Fully Offline Outboard Option is the only option that would not impact Town of Bourne-owned property.

**8.3.2.4 Split**

In this option, the two barrels of the replacement highway bridge would be located on either side of existing Bourne Bridge; the southbound barrel of the replacement highway bridge would be west of existing Bourne Bridge (closer to Buzzards Bay) and the northbound barrel of the replacement highway bridge would be east of existing Bourne Bridge (closer to Cape Cod Bay). Figure 8-5 presents a sketch of the Split Option.



**Figure 8-5. Bourne Bridge Split Option**

*Constructability Rating: Neutral*

This option would allow for full offline construction of the replacement highway bridge, benefiting the construction schedule while providing the contractor with flexibility regarding the construction phasing. However, there would be adverse constructability issues with this option: this option would involve construction over the Bourne Rotary and extensive access issues to existing businesses south of the rotary. In this option, existing ramp connections would be maintained during construction.

*Utility Impacts Rating: Neutral*

This option would indirectly impact the Enbridge Gas Metering Station. The bridge would not be directly over the metering station; however, the metering station would still need to be relocated for the construction of the new bridge. This option would result in multiple minor impacts to water, sewer, telecommunication, and electric utilities. Additionally, due to conflicts with the proposed main span bridge piers and abutments, this option would involve multiple drainage system impacts, including relocation of the twin 43-inch by 68-inch elliptical outfall pipes, as well as portions of the connecting upstream Route 28 drainage system.

*Right-of-Way Impacts Rating: Less Impactful*

The Split Option is the only option that would increase the transportation corridor width and State right-of-way. Based on preliminary design, this option would require one residential full property acquisition, four commercial partial property impacts, and six commercial full property acquisitions consisting of three service stations and three other businesses. None of the impacts would directly affect EJ populations or communities. Like the other options, the Split Option would impact Bourne Scenic Park. Impacts to USACE property would consist of approximately 382,000 sf of permanent impacts and approximately 696,000 sf of construction impacts. Impacts to the Town of Bourne property would consist of approximately 35,000 sf of construction impacts.

## 8.4 Sagamore Bridge Mainline Alignment Location Screening Results

Table 8-2 presents the screening results of the Sagamore Bridge mainline alignment location options and determination of the favorable option. The most favorable mainline location option for replacement of the Sagamore Bridge was determined to be the Fully Offline Inboard Option, where both barrels of the replacement highway bridge would be located outside the footprint of the existing bridge, approximately 10 feet apart and parallel to each other, on the on the side of the canal between the existing Bourne Bridge and Sagamore Bridge. The replacement structures for the Sagamore Bridge would be west of the existing bridge, closer to Buzzards Bay.

Table 8-2. Screening Results of Sagamore Bridge Mainline Alignment Location Options

Highway Design Evaluation Criteria (1), (2)	Fully Offline Inboard Option	Partially Offline Inboard Option	Partially Offline Outboard Option	Fully Offline Outboard Option	Split Option
Operations	●●	●●	●●	●●	●●
Connectivity	●	●	●	●	●
Geometrics	●●	●●	●	●	●
Safety	●●	●●	●●	●●	●●

Highway Design Evaluation Criteria (1), (2)	Fully Offline Inboard Option	Partially Offline Inboard Option	Partially Offline Outboard Option	Fully Offline Outboard Option	Split Option
<b>Constructability</b>	●	●●	●●●	●●●	●●●
<b>Multi-Modal</b>	●●	●	●	●	●
<b>Utilities</b>	●	●	●	●	●
<b>Environmental</b>	■ ■	■ ■	■ ■ ■	■ ■ ■	■ ■
<b>Right-of-Way</b>	❖	■	■ ■ ■	■ ■ ■ ■	■ ■ ■

(1) ●●● Most favorable; ●● Favorable; ● Neutral; ●● Less Favorable; ●●● Unfavorable; ●● Not Rated  
(2) Range of Least to Less Impacts= ■ ■ ■ ■ ■, ■ ■ ■ ■ ■, ■ ■ ■ ■ ■, ■ ■ ■ ■ ■; Medium Impacts= ❖ ; Range of More to Most Impacts= ■ ■ ■ ■ ■, ■ ■ ■ ■ ■, ■ ■ ■ ■ ■, ■ ■ ■ ■ ■

Among the five options for the Sagamore Bridge mainline alignment location, performance would be generally consistent regarding traffic operations, connectivity, and safety. Additionally, impacts to existing utilities would be similar among the options.

*Operations Rating: Favorable*

The location of the replacement bridge would not affect traffic operations capacity of the mainline over Cape Cod Canal. In all options, the improvements to lane and shoulder widths along with inclusion of auxiliary lanes would improve traffic operations relative to existing conditions, including traffic merging/diverging and weaving. All options would remove the Route 3 southbound lane drop.

*Connectivity Rating: Neutral*

All options would maintain existing roadway connections.

*Safety Rating: Favorable*

With the addition of acceleration and deceleration lanes, increased lane widths, increased shoulder widths, geometric improvements to the vertical profile curves, improved ramp acceleration and deceleration areas, and addition of a median barrier, safety conditions would improve in all options, resulting in a reduction in predicted crashes and a favorable safety rating. In all options, geometric improvements to the vertical profile curves would improve stopping sight distances.

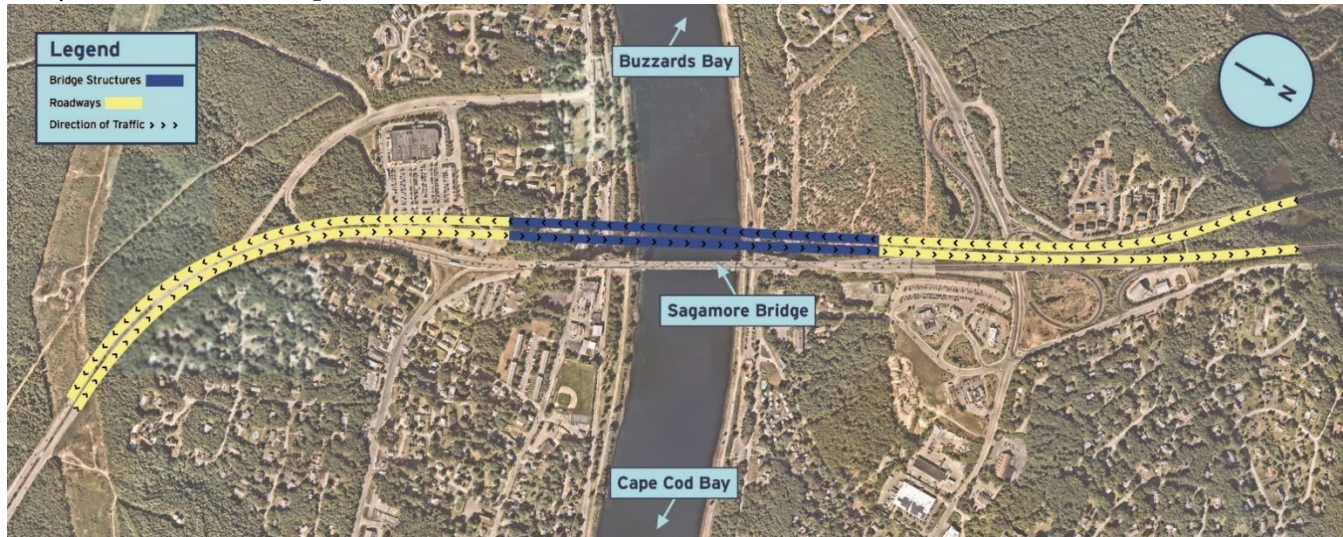
*Utility Impacts Rating: Neutral*

Regarding potential utility impacts, the options receive a neutral rating relative to each other. All options would displace the Enbridge Gas metering station, and each option would involve some direct and/or indirect impacts to existing utilities, consisting of gas, water, telecommunications, and electrical. Sections 8.4.1 and 8.4.2 discuss the major evaluation criteria of geometrics, constructability, multi-modal connections, environmental impacts, and right-of-way impacts that are differentiators, as shown in Table 8-2, and present MassDOT’s decisions to advance or dismiss the Sagamore Bridge mainline alignment location options for further design.<sup>12</sup>

<sup>12</sup> Note that additional right-of-way impacts would occur when Sagamore mainline location options are paired with the interchange approach options, as presented in Section 8.

#### 8.4.1 OPTION ADVANCED FOR FURTHER EVALUTATION: FULLY OFFLINE INBOARD

In this option, both barrels of the replacement highway bridge would be located west of and outside the footprint of the existing Sagamore Bridge, closer to Buzzards Bay. Figure 8-6 presents a sketch of the Fully Offline Inboard Option.



**Figure 8-6. Sagamore Bridge Fully Offline Inboard Option**

##### *Geometrics Rating: Favorable*

This option would eliminate the reverse curve in the roadway alignment south of the existing bridge by replacing it with a long tangent connecting to existing curves at the southern and northern end of the bridge. By shifting the mainline west of and outside the footprint of the existing Sagamore Bridge, this option would provide space to add bicycle and pedestrian accommodations along State Road. This option would better accommodate connections to the approach road network that provides an on-ramp near the Christmas Tree Shop and an off-ramp near the Park & Ride lot. In this option, the Route 6 eastbound and Route 3 northbound mainline curve lengths north of the canal would meet the minimum MassDOT design requirements.

##### *Constructability Rating: Neutral*

With a fully offline construction, this option would have the largest construction laydown area west of existing Sagamore Bridge, which would facilitate construction of both barrels of the replacement bridge. MassDOT is evaluating two construction approaches in the Fully Offline Inboard Option. In the first approach, MassDOT would keep the existing bridge in service through construction of both replacement bridges; however, this approach would require ongoing inspections of the existing bridge and existing bridge rehabilitation could be necessary. In the second approach, MassDOT would construct the first bridge and transfer existing traffic (providing bi-directional traffic) following its construction; however, this approach would require difficult temporary ramp connections. In this option, the southbound Route 3 bridge and approaches over Scenic Highway could be built without affecting the existing on-Cape traffic. The Route 3 northbound bridge and approaches would be built in two phases.

*Multi-Modal Connections Rating: Favorable*

The Fully Offline Inboard Option is the only option that could accommodate bicycle and pedestrian access along State Road.

*Environmental Impacts Rating: Less Impactful*

In this option, no direct wetland impacts are anticipated. The Fully Offline Inboard Option would be within previously disturbed portions of the Herring River Watershed Area of Critical Environmental Concern (ACEC) within the State highway layout. Due to replacement of the existing bridge, this option would result in an Adverse Effect to the NRHP-eligible Sagamore Bridge under Section 106 of the NHPA.

*Right-of-Way Impacts Rating: Medium*

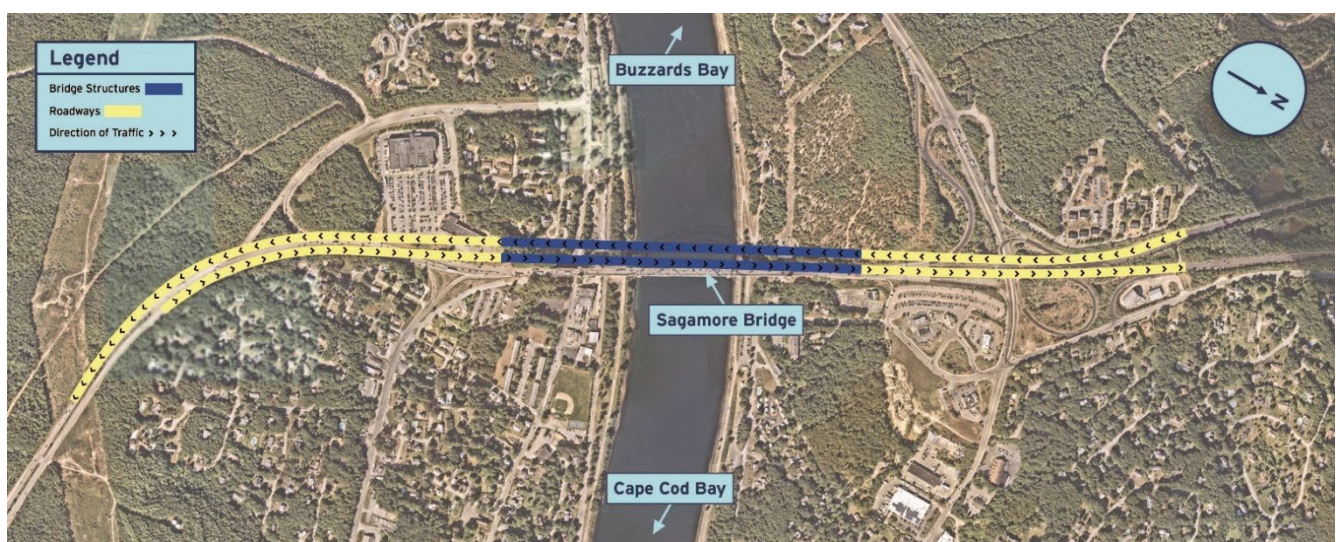
Based on preliminary design, this option would result in 11 residential full property acquisitions, including an undeveloped parcel; one commercial partial property impact, consisting of one building with three active businesses and four vacancies; and two commercial full property acquisitions, including one vacant parcel and one construction yard. None of the impacts would directly affect EJ populations or communities.

Additionally, construction of this option would temporarily impact approximately 43,100 sf of Town of Bourne-owned property. This option also would impact USACE property, involving approximately 369,500 sf of construction impacts due to the construction laydown area and approximately 304,000 sf of permanent impacts.

### 8.4.2 OPTIONS DISMISSED FROM FURTHER EVALUATION

#### 8.4.2.1 Partially Offline Inboard

In this option, the replacement highway bridge would be located west of and partially within the footprint of the existing Sagamore Bridge, toward Buzzards Bay. Figure 8-7 presents a sketch of the Partially Offline Inboard Option.



**Figure 8-7. Sagamore Bridge Partially Offline Inboard Option**

#### *Geometrics Rating: Favorable*

In the Partially Offline Inboard Option, the mainline curve lengths would be less than the desired lengths per MassDOT's Project Development and Design Guide, but most curve lengths would meet the minimum mainline curve lengths. By locating the proposed mainline alignment close to the existing Sagamore Bridge, this option would result in steeper ramp profile grades for the approaching road network that provides an on-ramp near the Christmas Tree Shop south of the canal and an off-ramp near the Park & Ride lot north of the canal.

#### *Constructability Rating: Less Favorable*

In this option, MassDOT would first construct the eastbound replacement bridge, transfer the existing traffic (providing bi-directional traffic) to the new eastbound bridge, demolish the existing bridge, and then construct the westbound replacement bridge. This construction approach would require construction of a temporary Route 3 southbound structure and a temporary structure over Scenic Highway. The required temporary ramp connections, especially the on-Cape westbound on-ramp and the off-Cape westbound off-ramp, would be difficult with this option's alignment shift to the east. Additionally, some existing ramp connections would not be maintained during construction and multiple short term ramp closures could be required. Compared to the Fully Offline Inboard Option, the Partially Offline Inboard Option would involve a substantial construction duration due to complex construction staging with multiple construction stages, mobilization inefficiencies due to constrained laydown areas, and major multiple traffic pattern changes/diversions which would disrupt existing traffic flows.

#### *Multi-Modal Connections Rating: Neutral*

Utilizing the existing easterly State Road Layout line, the Partially Offline Inboard Option would not be able to accommodate bicycle and pedestrian access along State Road without also incurring right-of-way impacts.

#### *Environmental Impacts Rating: Less Impactful*

Like the Fully Offline Inboard Option, in this option, no direct wetland impacts are anticipated. This option would be within previously disturbed portions of the Herring River Watershed ACEC within the State highway layout.

#### *Right-of-Way Impacts Rating: More Impactful*

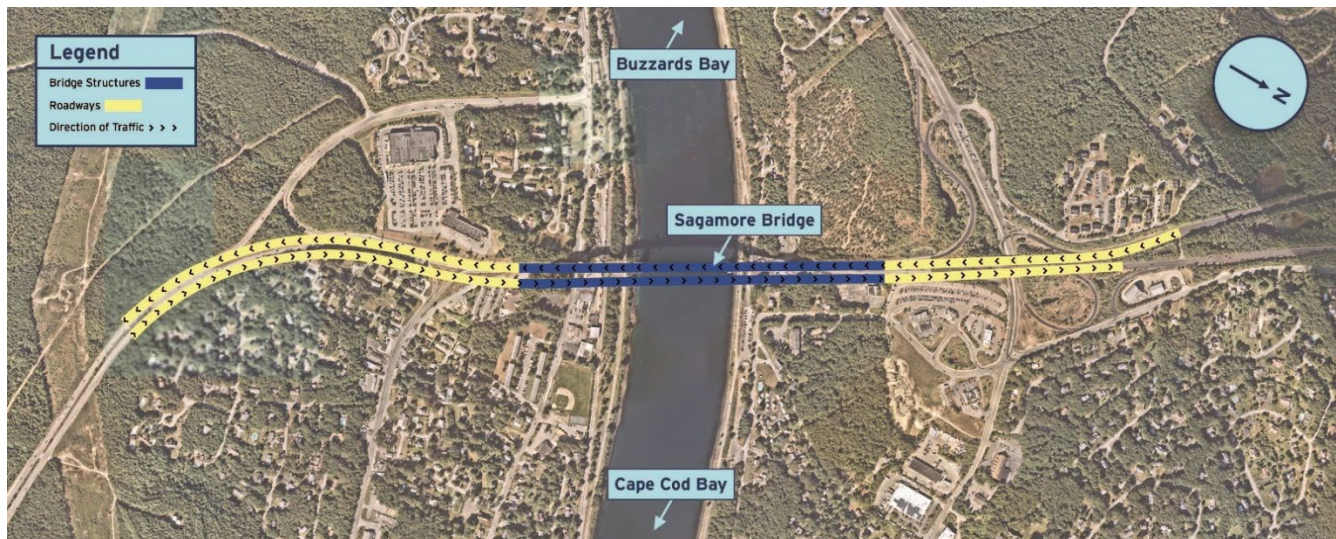
Based on preliminary design, this option would result in two residential partial property impacts; seven residential full property acquisitions, including two undeveloped parcels; two commercial partial property impacts, including an undeveloped parcel and one building with three active businesses and four vacancies; and three commercial full property acquisitions, including one active business, one vacant parcel and one construction yard. None of the impacts would directly affect EJ populations or communities.

Construction of this option would impact approximately 43,100 sf of Town of Bourne-owned property. This option also would impact USACE property, involving approximately 386,500 sf of construction impacts due to the construction laydown area and approximately 304,900 sf of permanent impacts.



#### 8.4.2.2 Partially Offline Outboard

In this option, the replacement highway bridge would be located east of and partially within the footprint of the existing Sagamore Bridge, toward Cape Cod Bay. Figure 8-8 presents a sketch of the Partially Offline Outboard Option.



**Figure 8-8. Sagamore Bridge Partially Offline Outboard Option**

#### *Geometrics Rating: Neutral*

In this option, Route 6 eastbound and Route 6 westbound mainline curve lengths north and south of the canal would be less than both the desired and minimum lengths per MassDOT's Project Development and Design Guide (PDDG). Additionally, this option would require an additional six feet of inside shoulder to meet the sight stopping distance for a 60 miles per hour (MPH) design speed.

#### *Constructability Rating: Unfavorable*

In this option, MassDOT would first construct the westbound replacement bridge, transfer the existing traffic (providing bi-directional traffic) to the new westbound bridge, demolish the existing bridge, and then construct the eastbound replacement bridge. This construction approach would require temporary ramp connections which would be difficult with this option's alignment shift to the east, especially the on-Cape westbound on-ramp and the off-Cape westbound off-ramp. Additionally, some existing ramp connections would not be maintained during construction, requiring multiple short term ramp closures and temporary ramp connections. For example, the eastbound on-ramp from Scenic Highway and the eastbound off-ramp to the Mid-Cape Connector would be closed for extended periods while the existing bridge is demolished, and the temporary ramp connections are constructed. In comparison to the Fully Offline Inboard Option, the Partially Offline Outboard Option would involve a substantial construction duration due to complex construction staging with multiple construction stages, mobilization inefficiencies due to constrained laydown areas, and major multiple traffic pattern changes/diversions which would disrupt existing traffic flows.

*Multi-Modal Connections Rating: Neutral*

Utilizing the existing easterly State Road Layout line, the Partially Offline Outboard Option would not accommodate the addition of bicycle and pedestrian access along State Road without right-of-way impacts.

*Environmental Impacts Rating: Less Impactful*

In this option, no direct wetland impacts are anticipated. Additionally, this option has no anticipated impacts to the Herring River Watershed ACEC. Compared to the Fully Offline and Partially Offline Inboard options, this option would be less impactful.

*Right-of-Way Impacts Rating: More Impactful*

Based on preliminary design, this option would result in four residential full property acquisitions, including one undeveloped parcel; one commercial partial property impact, including an undeveloped parcel and one building with three active businesses and four vacancies; and seven commercial full property acquisitions, consisting of a service station, two other active businesses, two undeveloped parcels, a warehouse, and a construction yard. None of the impacts would directly affect EJ populations or communities.

Construction of this option would impact approximately 43,100 sf of Town of Bourne-owned property. This option also would impact USACE property, involving approximately 358,400 sf of construction impacts due to the construction laydown area and approximately 213,500 sf of permanent impacts. Compared to the Partially Offline Inboard Option, the Partially Offline Outboard Option would be more impactful.

**8.4.2.3 Fully Offline Outboard**

In this option, both barrels of the replacement highway bridge would be located east of and outside the footprint of the existing Sagamore Bridge, closer to Cape Cod Bay. Figure 8-9 presents a sketch of the Fully Offline Outboard Option.



**Figure 7-9. Sagamore Bridge Fully Offline Outboard Option**

#### *Geometrics Rating: Neutral*

In this option, Route 6 eastbound and Route 6 westbound mainline curve lengths north of the canal would be less than both the desired and minimum lengths per MassDOT's PDDG. Route 6 eastbound and Route 6 westbound mainline curve lengths south of the canal would be less than the desired lengths but would meet the minimum lengths per MassDOT's PDDG.

#### *Constructability Rating: Unfavorable*

In this option, MassDOT would need to construct both the eastbound and westbound replacement structures, then transfer the existing traffic to the new structures, and then demolish the existing bridge. MassDOT would construct the Route 3 bridges over Scenic Highway in multiple phases. While both the westbound and eastbound bridges could be built without affecting the existing bridge, this option would require extended durations of multiple closed ramp connections to the mainline. Additionally, the required temporary ramp connections would be difficult with this option's alignment shift to the east, especially the on-Cape westbound on-ramp and the off-Cape westbound off-ramp. In comparison to the Fully Offline Inboard Option, the Fully Offline Outboard Option would involve complex construction staging with multiple construction stages, mobilization inefficiencies due to constrained laydown areas, and major multiple traffic pattern changes/diversions which would disrupt existing traffic flows.

#### *Multi-Modal Connections Rating: Neutral*

Utilizing the existing easterly State Road Layout line, the Fully Offline Outboard Option would not accommodate the addition of bicycle and pedestrian access along State Road without right-of-way impacts.

#### *Environmental Impacts Rating: Less Impactful*

Like the Partially Offline Outboard option, no direct wetland impacts or impacts to the Herring River Watershed ACEC are anticipated. Compared to the Fully Offline and Partially Offline Inboard options, this option would be less impactful.

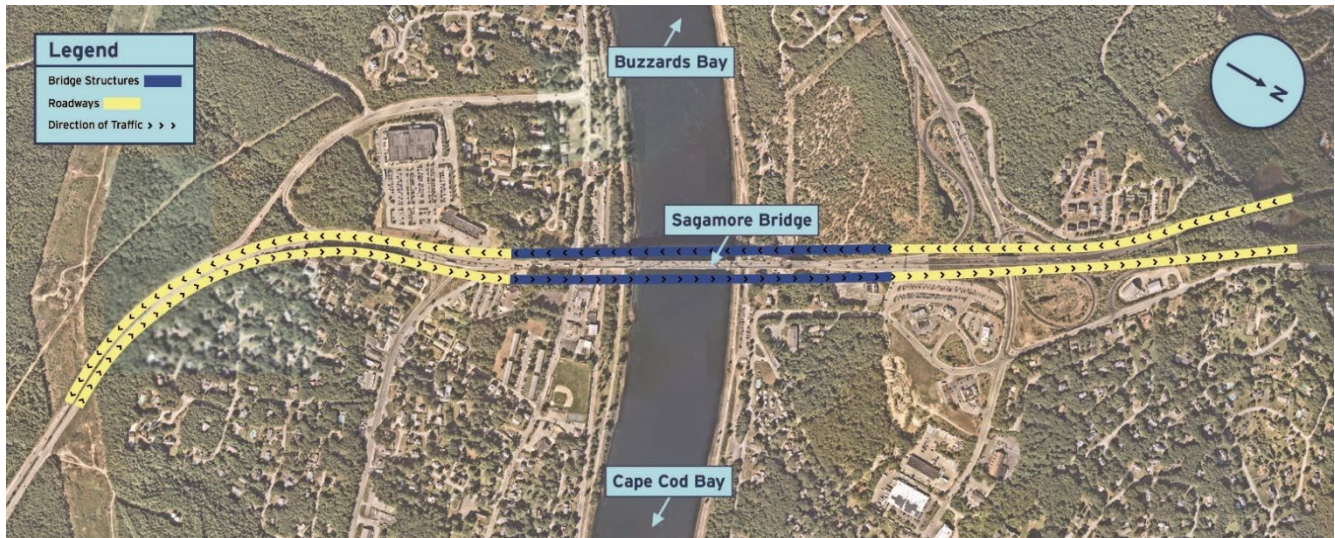
#### *Right-of-Way Impacts Rating: Most Impactful*

Based upon preliminary design, the Fully Offline Outboard Option would have the most impactful right-of-way impacts compared to other options. This option would result in the most substantial disruption to the community and would require five residential partial property impacts; 30 residential full property acquisitions; two commercial partial property impacts, including an undeveloped parcel and one building with three active businesses and four vacancies; and eight commercial full property acquisitions, consisting of five active businesses, two undeveloped parcels, and a warehouse. None of the impacts would directly impact EJ populations or communities. Construction of this option would impact approximately 43,100 sf of Town of Bourne-owned property. This option would impact USACE property, involving approximately 264,000 sf of construction impacts due to the construction laydown area and approximately 253,700 sf of permanent impacts. Additionally, the Fully Offline Outboard Option would displace MassDOT's Park and Ride Lot.

#### **8.4.2.4 Split**

In this option, the two barrels of the replacement highway bridge would be located on either side of existing Sagamore Bridge; the westbound barrel of the replacement highway bridge would be east of existing Sagamore Bridge, closer to Cape Cod Bay, and the eastbound barrel of the replacement highway

bridge would be west of existing Sagamore Bridge, closer to Buzzards Bay. Figure 8-10 presents a sketch of the Split Option.



**Figure 8-10. Sagamore Bridge Split Open**

*Geometrics Rating: Neutral*

Like the Partially Offline Outboard Option, in this option, Route 6 eastbound and Route 6 westbound mainline curve lengths north and south of the canal would be less than the both the desired and minimum lengths per MassDOT's PDDG.

*Constructability Rating: Unfavorable*

In this option, MassDOT would construct the westbound replacement structure, transfer the existing traffic (providing bi-directional traffic) to the new westbound bridge, construct the eastbound structure, transfer the existing traffic to the replacement structures, and then demolish the existing bridge. A temporary Route 3 southbound structure and a temporary structure over Scenic Highway would be needed. The required temporary ramp connections would be difficult with this option's alignment shift to the east, especially the on-Cape westbound on-ramp and the off Cape westbound off-ramp. In comparison to the Fully Offline Inboard Option, the Split Option would involve substantially more construction time due to the demolition of the existing bridge after construction of the replacement bridge structures. Additional challenges of this option would include complex construction staging with multiple construction stages, especially related to the construction of the Route 3 northbound and southbound bridges over the Scenic Highway.

*Multi-Modal Connections Rating: Neutral*

Utilizing the existing easterly State Road Layout line, the Split Option would not accommodate the addition of bicycle and pedestrian access along State Road without right-of-way impacts.

*Environmental Impacts Rating: Less Impactful*

In this option, no direct wetland impacts are anticipated. Like the two inboard options, the Split Option would disturb portions of the Herring River Watershed ACEC within the State highway layout. The less

impactful environmental impact rating of the Split Option is comparable to the two inboard option ratings.

*Right-of-Way Impacts Rating: More Impactful*

Based on preliminary design, this option would result in nine residential full property acquisitions, including three undeveloped lots; one commercial partial property impact, including an undeveloped parcel and one building with three active businesses and four vacancies; and seven commercial full property acquisitions, consisting of three active businesses, two undeveloped parcels, a warehouse, and a construction yard. None of the impacts would directly affect EJ populations or communities.

Construction of this option would impact approximately 43,100 sf of Town of Bourne-owned property. This option would impact USACE property, involving approximately 442,300 sf of construction impacts and approximately 273,100 sf of permanent impacts. Additionally, the Split Option would displace MassDOT's Park and Ride Lot.

## 9 Phase 1 Highway Interchange Approach Assessments

MassDOT used the Fully Offline Inboard mainline alignment location for both the Bourne and Sagamore crossings as the basis for identifying and evaluating interchange approach alternatives for the four quadrants of the canal crossings. The four quadrants, referenced as Bourne North, Bourne South, Sagamore North, and Sagamore South, are shown in Figure 9-1.

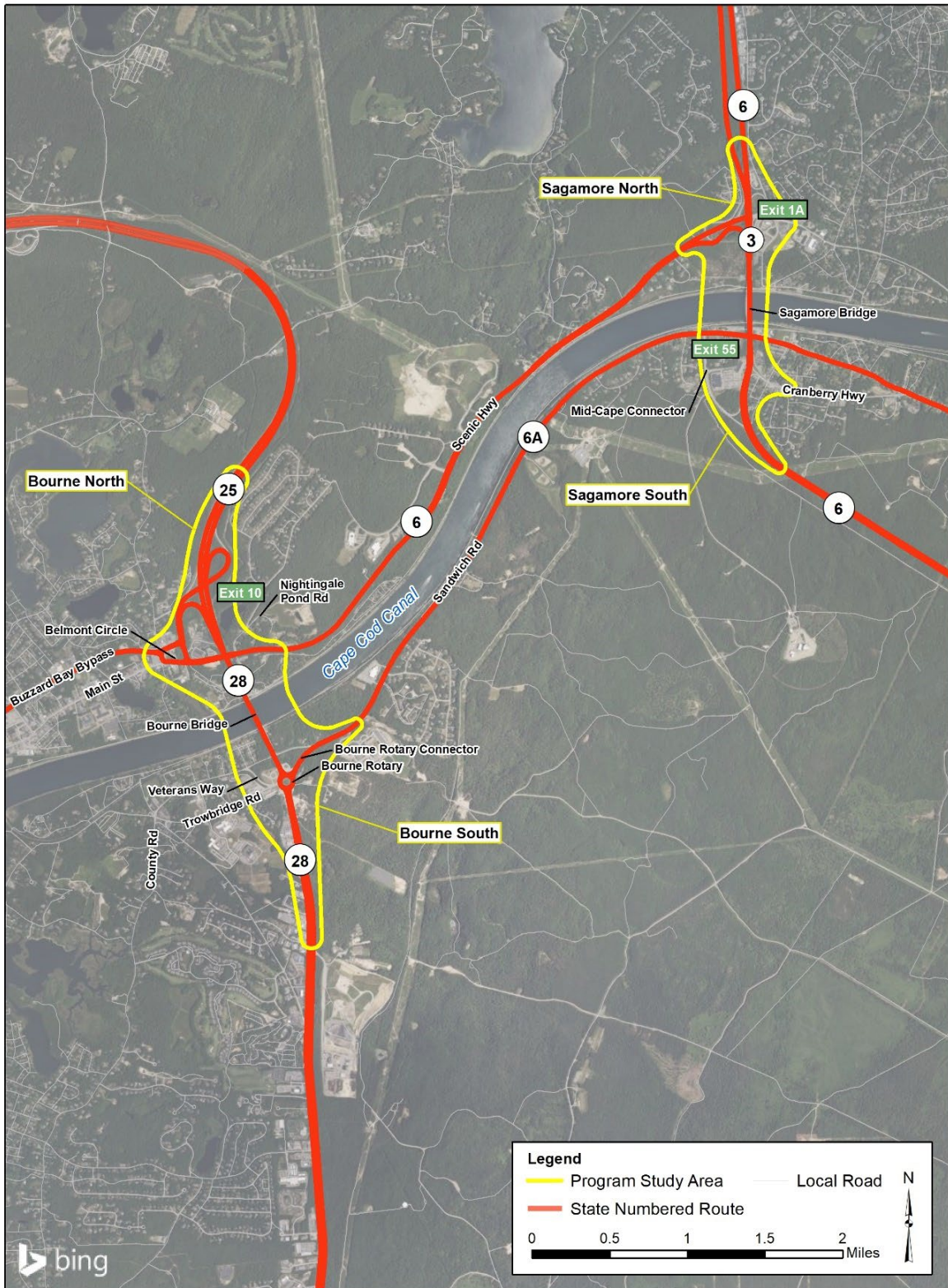


Figure 9-1. Bourne and Sagamore Program Study Area Quadrants

## 9.1 Initial Investigations

Using the alternatives identified in the Cape Cod Canal Area Transportation Study as its starting point, MassDOT initially identified and screened a total of 67 highway interchange approach concepts, consisting of 24 options for Bourne North, 17 options for Bourne South, nine options for Sagamore North, and 17 options for Sagamore South. The initial screening consisted of defining concepts according to three status levels:

- Active, where the concept was deemed to be a viable option to be further refined;
- Incorporated Elsewhere, where portions of the concept were viable and incorporated into another option;
- Not Being Further Developed (NBFD), where the concept demonstrated fatal flaws and was dismissed.

MassDOT screened the concepts according to feasibility and reasonability. Concepts that presented significant geometric or safety challenges, did not provide all necessary connections, or posed infeasible constructability issues were identified as fatal flaw, NBFD options, and were dismissed. Additionally, concepts that were like other more favorable options were incorporated elsewhere and were eliminated. Of the 41 concepts MassDOT initially created for the Bourne Program Study Area, 11 concepts were defined as active, five concepts were incorporated elsewhere, and 25 concepts were defined as NBFD. Of the 26 concepts MassDOT initially created for the Sagamore Program Study Area, 13 concepts were defined as active, three concepts were incorporated elsewhere, and ten concepts were defined as NBFD.

From this conceptual screening, MassDOT identified options that would be advanced to a more detailed evaluation process as design progresses. Appendix D provides details of this initial screening.

## 9.2 Interchange Approach Conceptual Screening Methodology

Like the mainline alignment location options assessment, MassDOT established the following Program design criteria to evaluate optional configurations for the interchange approaches at the bridge crossings, based on conceptual design:

- Operations - Improve existing traffic operations.
- Connectivity – Maintain or improve existing roadway connections.
- Geometrics - Meet or exceed current MassDOT and FHWA design standards, without design exceptions, including but not limited to curve lengths, stopping sight distances, and desired profile grades for roadway-bridge connections. The desired profile grades are 4.5 percent for the Bourne crossing and 4 percent for the Sagamore crossing.
- Safety - Improve safety conditions by reducing predicted crash frequency, crash rate, crash type, and/or crash severity.
- Constructability - Maximize constructability and construction efficiency, including maintaining two traffic lanes in each direction at each crossing during construction, maintaining all connections to the local roadway network at locations like the existing condition during

construction, maintaining and/or improving schedule and costs, minimizing impacts to the traveling public, and reducing complexity relative to staging and need for temporary structures.

- Multi-Modal Connections- Provide for multi-modal connections through barrier separated bicycle and pedestrian accommodations on the bridge structure and to the interchange approach network.
- Utility Impacts – Minimize direct and indirect impacts to existing utilities, including relocations.
- Environmental Impacts- Minimize impacts to protected resources.
- Right-of-Way Impacts - Minimize impacts to properties, including full acquisitions and partial impacts, potential displacement, and adverse effects to Environmental Justice (EJ) communities.

Based on 2045 No-Build (no action) traffic volumes, MassDOT preliminarily assessed future traffic operations using several traffic analysis and modeling programs.<sup>13</sup> To preliminarily assess safety conditions of the options relative to the 2045 No-Build traffic volumes, MassDOT conducted engineering assessments consistent with AASHTO’s Highway Safety Manual. MassDOT estimated utility, environmental, and right-of-way impacts using the interchange conceptual footprints.

Options were rated based on their performance relative to meeting the Program design evaluation criteria; the ratings were then compared to identify alternatives that would be advanced to a secondary level of screening (Phase 2 evaluations). MassDOT placed high priority on interchange approach options that would be practical and feasible to construct and maintain; options that would not be practical and feasible were dismissed from further evaluation. MassDOT used an unscaled, qualitative rating scheme to facilitate the screening.

The following sections summarize the findings of the preliminary (Phase 1) screening of interchange approach options for the Bourne north and south and Sagamore north and south locations. MassDOT used an unscaled, qualitative rating scheme to facilitate the conceptual screening. Of particular importance are options that were evaluated to have one or more Unfavorable, triple-red (●●●) ratings indicating options that presented considerable drawbacks.

The impacts presented herein are conceptual, particularly regarding environmental and right-of-way impacts. It is important to note that the right-of-way impacts identified for the Bourne and Sagamore crossing interchange approach options would be added to the anticipated right-of-way impacts associated with MassDOT’s preferred option for the mainline alignment location at both crossings: the Fully Offline Inboard alignment. As the design and construction staging approaches are further developed, environmental and right-of-way impacts may change.

---

<sup>13</sup> Traffic analysis and modeling software included Synchro, Highway Capacity Software, SIDRA Software, and VISSIM.



### 9.3 Bourne North Crossing Interchange Approach Screening Results

MassDOT identified four interchange approach options for the Bourne North area and conducted a preliminary assessment relative to the highway design criteria. All four approach options would meet current MassDOT and FHWA design standards. The northbound and southbound ramps would be designed for a minimum speed of 30 MPH. The four options receive a consistent neutral or better safety impacts rating and a favorable or better connectivity rating. All four options receive a favorable multi-modal connections rating; each would include an independent shared use path on the bridge that would provide a 4.50 percent longitudinal profile grade off the mainline structure. It is anticipated that path routing would be fairly circuitous to provide the length necessary to allow the path to descend from the bridge structure elevation to the elevation of the path termini. The four approach options largely differ regarding operations, constructability, and environmental and right-of-way impacts.

Table 9-1 presents the screening results of the Bourne North crossing interchange approach options. Based on the conceptual screening, MassDOT is advancing Options BN-6.1, BN-13.1, and BN-14.4b as Bourne North crossing interchange approach alternatives to be further evaluated in a Phase 2 alternatives analysis.

Table 9.1. Screening Results of Bourne North Crossing Interchange Approach Options

Highway Design Evaluation Criteria (1), (2)	BN-6.1	BN-10	BN-13.1	BN-14.4b
Operations	●●	●	●●	●●●
Connectivity	●●	●●●	●●	●●●
Geometrics	●●	●	●●	●●
Safety	●	●	●	●●
Constructability	●●●	●	●	●
Multi-Modal	●●	●●	●●	●●●
Utilities	●●	●●	●●	●●
Environmental	■ ■	■ ■ ■ ■	■ ■	■ ■
Right-of-Way	■ ■ ■	■	■	■ ■

(1): ●●● Most favorable; ●● Favorable; ● Neutral; ●● Less Favorable; ●●● Unfavorable; ●● Not Rated

(2) Range of Least to Less Impacts= ■ ■ ■ ■, ■ ■ ■, ■ ■, ■; Medium Impacts= ❖; Range of More to Most Impacts= ■, ■ ■, ■ ■ ■, ■ ■ ■ ■

Sections 9.3.1 and 9.3.2 discuss MassDOT’s decisions to advance or dismiss the Bourne North crossing highway interchange options for a secondary evaluation.

#### 9.3.1 OPTIONS ADVANCED FOR FURTHER EVALUATION

##### 9.3.1.1 Option BN-6.1

Option BN-6.1 largely mimics the existing interchange configuration. All entering and exiting movements utilize existing ramp configurations with minor modifications to meet the offset mainline while adding a new northbound on-ramp directly from Scenic Highway east of the mainline. Like existing conditions, the termini of the ramps are in the northeast quadrant of Belmont Circle. In addition to maintaining the existing ramp configurations, Option BN-6.1 adds a second northbound

access point from Route 6 (Scenic Highway) to Route 25. Access to this ramp is located along Scenic Highway between the relocated mainline and the existing intersection with Nightingale Road. The new ramp alignment closely follows the relocated mainline alignment before curving east, away from the mainline, to reconnect with the curvature of the existing northbound on/off loop ramp. The new ramp merges with the existing northbound on-ramp before merging with the Route 25 mainline highway. Figure 9-2 shows a conceptual layout of Option BN-6.1.

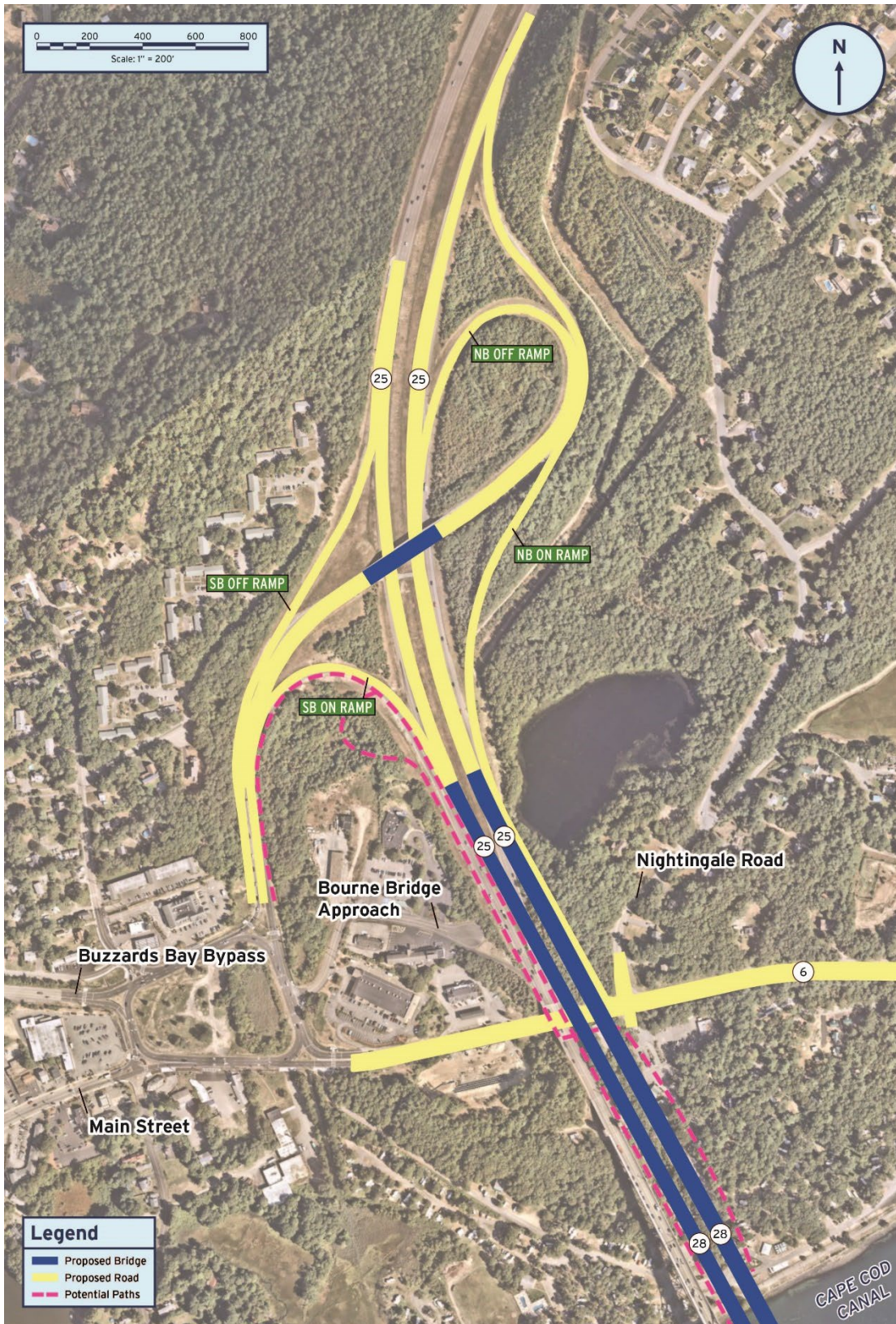


Figure 9-2. Bourne North Crossing Interchange Approach Option BN-6.1

*Operations, Connectivity, and Geometrics Ratings: Favorable*

This option would largely mimic existing connections. The new Route 25 northbound on-ramp would provide an additional access route to Route 25 northbound and would reduce westbound traffic at Belmont Circle. This option would not add southbound connections, however; therefore, it would not improve any southbound movements at the interchange approach. This option would meet current MassDOT and FHWA design standards, with the northbound off-ramp and the southbound on-ramp designed to meet a minimum design speed of 30 MPH.

*Safety Rating: Neutral*

Due to improved geometric and cross-sectional features of the new ramp facility, engineering assessments and safety modeling indicate that the overall highway and ramp segment crash rates are predicted to be slightly reduced in comparison to the base condition. However, the interaction between vehicles exiting Nightingale Road and entering the new northbound on-ramp could contribute to crashes, negating some of the projected safety improvements. Methods of improving the safety operations of this potential conflict area would require further investigation as design progresses.

*Constructability Rating: Most Favorable*

Besides the new northbound on-ramp connection, there would be no other additional structures, resulting in minimal impacts to the traveling public and no additional construction complexity. Compared to the other Bourne North crossing interchange approach options, Option BN-6.1 would result in a one-year schedule reduction.

*Multi-Modal Connections Rating: Favorable*

It is anticipated that connections to the local road network would be provided by shared use path direct connections to Belmont Circle and the USACE Canal Service Road (bike path).

*Utility Impacts Rating: Favorable*

Utility impacts would be limited to some minor water main impacts; relocation of 18 utility poles, overhead wires, and other minor electrical impacts; and minor drainage impacts. This option would not involve notable telecommunications or sewer impacts. Impacts to gas infrastructure would not notably increase over those impacts anticipated due to the relocated mainline (Route 25) construction.

*Environmental Impacts Rating: Less Impactful*

Option BN-6.1 would not involve direct impacts to environmental resources. However, the ramp connection would be within five feet of Nightingale Pond and the proposed shared use path over wetlands could create indirect (shading) impacts to approximately 2,000 sf of wetlands.

*Right-of-Way Impacts Rating: Less Impactful*

Based on conceptual design, this option would involve right-of-way impacts in addition to those previously identified for the mainline alignment fully offline inboard location. Option BN-6.1 would result in three residential partial property impacts and two commercial property partial impacts, including minor property impacts to the 4-acre, Sav-On Mart mixed use development and a 10-pump gasoline station. The impacts would not directly affect EJ communities or populations.

### 9.3.1.2 Option BN-13.1

Option BN-13.1 builds upon the concepts introduced in Option BN-6.1, where all entering and exiting movements utilize existing ramp configurations with minor modifications to meet the proposed offset mainline and to improve acceleration and deceleration distances. Option BN-13.1 also adds a connection from Route 25 southbound off-ramp directly to Scenic Highway. The new direct connection from Route 25 southbound to Route 6 (Scenic Highway) is possible via a division of the existing southbound off-ramp that continues south parallel to the relocated mainline. This alignment requires the Route 25 southbound off-ramp to pass under the Route 25 southbound on-ramp in a braided ramp configuration. After passing under the southbound on-ramp, the off-ramp continues south until it intersects with Scenic Highway at an at-grade intersection. The Route 25 connection with Scenic Highway eastbound is west of the Nightingale Road intersection and is controlled by a signal. Figure 9-3 shows a conceptual layout of Option BN-13.1.



Figure 9-3. Bourne North Crossing Interchange Approach Option BN-13.1

*Operations, Connectivity, and Geometrics Ratings: Favorable*

In comparison to existing conditions, this option would provide two additional direct access routes to and from Route 25: from Scenic Highway westbound to Route 25 northbound and from Route 25 southbound to Scenic Highway eastbound. Both new access routes would reduce westbound and southbound traffic at Belmont Circle. Furthermore, additional design would be needed to ensure that the westbound traffic queue at the new signalized intersection west of Nightingale Road would avoid queue blockage at the Nightingale Road intersection. This option would meet current MassDOT and FHWA design standards, with the northbound off-ramp and the southbound on-ramp designed to meet a minimum design speed of 30 MPH.

*Constructability Rating: Neutral*

Due to the construction of the Route 25 bridge and southbound on-ramp over the southbound off-ramp, this option would add an additional year of construction compared to Option BN-6.1. While there would be minimal impacts to the traveling public, the construction of the skewed Route 25 southbound on-ramp over the Route 25 off-ramp would create a complex abutment/pier arrangement.

*Safety Rating: Neutral*

While the additional ramp facilities connecting Route 25 and Scenic Highway would remove major vehicle movements from Belmont Circle, engineering assessments and safety modeling predict similar highway and ramp segment crash rates in this option compared to the future no-build conditions.

*Multi-Modal Connections Rating: Favorable*

It is anticipated that connections to the local road network would be provided by shared use path direct connections to Belmont Circle and the USACE Canal Service Road (bike path).

*Utility Impacts Rating: Favorable*

Like Option BN-6.1, utility impacts in Option BN-13.1 would be limited to minor impacts relative to water; electrical, with relocation of 18 utility poles and overhead wires; and drainage. There would be no notable telecommunications or sewer impacts resulting from this option. Impacts to gas infrastructure would not notably increase over those impacts anticipated due to the relocated mainline construction.

*Environmental Impacts Rating: Less Impactful*

No direct environmental impacts are anticipated in this option. However, the Route 25 northbound on-ramp connection would be within five feet of Nightingale Pond.

*Right-of-Way Impacts Rating: Least Impactful*

Based on conceptual design, this option would involve right-of-way impacts in addition to those previously identified for the mainline alignment fully offline inboard location. Option BN-13.1 would result in four residential partial property impacts and three commercial partial property impacts, including minor property impacts of the 4-acre Sav-On Mart new development. The impacts would not directly affect EJ communities or populations.

### 9.3.1.3 Option BN-14.4b

Option BN-14.4b addresses the high travel demand movements from Route 25 to Route 6 (Scenic Highway) by providing a combination of direct connection ramps. Option BN-14.4b provides a connection between Route 6 westbound and Route 25 northbound with an exit ramp from Route 6 westbound prior to the Nightingale Road intersection. The ramp passes over Nightingale Road before turning northerly to continue parallel to the relocated Route 25 mainline, like the ramp alignments proposed in Options BN-6.1 and BN-13.1. Option BN-14.4b provides a connection between Route 25 southbound and Route 6 eastbound with an off-ramp, following a similar alignment to the ramp proposed in Option BN-13.1. However, rather than the ramp terminating at the at-grade intersection proposed in Option BN-13.1, in Option BN-14.4b, the ramp stays elevated and spans over Route 6 while curving easterly. It then crosses under the relocated Route 25 mainline before merging with Route 6 eastbound after the Nightingale Road intersection. All other movements in Option BN-14.4b maintain the existing ramp configurations with termini in the northeast quadrant of Belmont Circle. Figure 9-4 shows a conceptual layout of Option BN-14.4b.



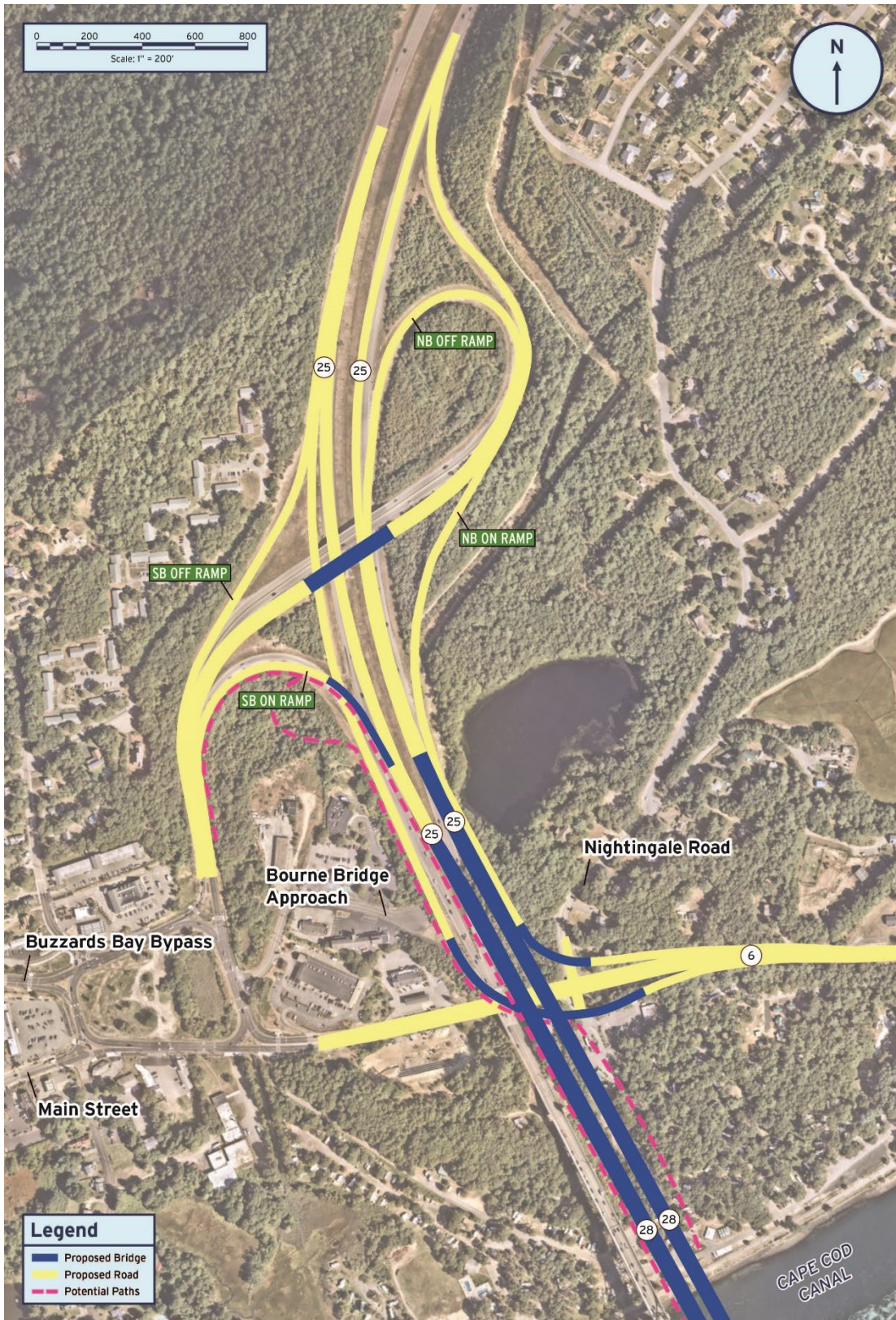


Figure 9-4. Bourne North Crossing Interchange Approach Option BN-14.4b

*Operations and Connectivity Ratings: Most Favorable*

In comparison to existing conditions and like Option BN-13.1, this option would provide two additional direct access routes to and from Route 25: the Scenic Highway westbound to Route 25 northbound on-ramp and the Route 25 southbound to Scenic Highway eastbound off-ramp. Both new access routes would reduce westbound and southbound traffic at Belmont Circle. Additionally, since both the on-ramp and off-ramp connections would merge and diverge east of the Nightingale Road intersection, the ramp connections would reduce the westbound and eastbound traffic at the Nightingale Road intersection.

*Geometrics Rating: Favorable*

This option would meet current MassDOT and FHWA design standards, with the northbound off-ramp and the southbound on-ramp designed to meet a minimum design speed of 30 MPH.

*Constructability Rating: Neutral*

Due to the construction of the Route 25 bridge and southbound on-ramp over the southbound off-ramp, this option would add an additional year of construction as compared to Option BN-6.1. Like Option BN-13.1, there would be minimal impacts to the traveling public in Option BN-14.4b. However, the construction of the skewed Route 25 southbound on-ramp over the Route 25 off-ramp would create a complex abutment/pier arrangement.

*Safety Rating: Favorable*

While engineering assessments and safety modeling predict that the merge of eastbound Scenic Highway lanes west of the on-ramp merge may contribute to additional crashes on this portion of roadway, the additional ramp facilities connecting Route 25 and Scenic Highway would remove major vehicle movements from Belmont Circle. This reduction in vehicle movements would considerably improve safety through the Belmont Circle area. There would be similar highway and ramp segment crash rates in this option as compared to the future no-build conditions.

*Multi-Modal Connections Rating: Favorable*

It is anticipated that connections to the local road network would be provided by shared use path direct connections to Belmont Circle, the USACE Canal Service Road (bike path), and Scenic Highway.

*Utility Impacts Rating: Favorable*

Utility impacts in Option BN-14.4b would involve multiple minor water impacts; electrical impacts, with relocation of 19 utility poles and overhead wires; minor telecommunication impacts, and minor drainage impacts. Impacts to gas infrastructure would not notably increase over those impacts anticipated due to the relocated mainline construction.

*Environmental Impacts Rating: Less Impactful*

No direct environmental impacts are anticipated in this option. However, the Route 25 northbound on-ramp connection would be within five feet of Nightingale Pond.

*Right-of-Way Impacts Rating: Less Impactful*

Based on conceptual design, this option would involve right-of-way impacts in addition to those previously identified for the mainline alignment fully offline inboard location. Option BN-14.4b would result in one residential full parcel acquisition, three residential partial property impacts, and two

commercial partial property impacts, including minor property impacts of the 4-acre Sav-On Mart new development. The impacts would not directly affect EJ communities or populations.

### **9.3.2 OPTION DISMISSED FROM FURTHER EVALUATION: OPTION BN-10**

Option BN-10 maintains the existing exit and entrance points along Route 25 with minor modifications to the ramp configurations to accommodate the relocated Route 25 mainline roadway. Once exiting the highway, however, the Route 25 southbound to Route 6 (Scenic Highway) eastbound movement breaks away from the existing off ramp onto a separate ramp flyover that crosses over Belmont Circle while curving easterly. From there, the ramp descends and crosses under the relocated Route 25 mainline before merging with Route 6 (Scenic Highway) eastbound after the Nightingale Road intersection. Additionally, this option provides a direct connection ramp from Route 6 (Scenic Highway) westbound to Route 25 northbound while avoiding entry into Belmont Circle. Inclusion of this ramp requires the reconfiguration of the Bourne Bridge approach road to connect with Route 6 (Scenic Highway) east of the relocated Route 25 mainlines. Inclusion of the Route 25 SB to Route 6 eastbound flyover ramp requires the relocation of the Campground Access Road. Figure 9-5 shows a conceptual layout of Option BN-10.



*Operations and Geometrics Ratings: Neutral*

This option would reduce traffic at Belmont Circle. The Scenic Highway (Route 6) westbound to Route 25 northbound and Bourne Bridge southbound on-ramp connection would reduce westbound traffic at Belmont Circle, and the Route 25 southbound to Scenic Highway eastbound connection would reduce southbound traffic at Belmont Circle. However, the direct connections from Scenic Highway westbound to Route 25 northbound and the Bourne Bridge southbound could cause weaving issues due to the location of the merge and the weaving segment length. This option would meet current MassDOT and FHWA design standards, with the northbound off-ramp and the southbound on-ramp designed to meet a design speed of 30 MPH. However, Option BN-10 would include a substandard merge condition at the southbound on-ramp approach at Belmont Circle, providing less than 130-feet of merge (from a minimum requirement of 300-feet).

*Connectivity Rating: Most Favorable*

This option would provide direct access from Scenic Highway (Route 6) westbound to Route 25 northbound and Bourne Bridge southbound, and from Route 25 southbound to Scenic Highway eastbound; resulting in three additional direct access routes to and from Routes 25/28 compared to existing conditions. Additionally, this option would provide indirect access to local businesses at Belmont Circle.

*Safety Rating: Neutral*

Engineering assessments and safety modeling indicate that the ramp merge connection along Scenic Highway could contribute to additional crashes compared to ramps at signal or stop-controlled intersections. Further, the weave section along on-ramps in the Belmont Circle area could contribute to rear-end or side-side collisions that would not be expected with the other Bourne North interchange approach options.

*Constructability Rating: Neutral*

Due to the construction of the Route 25 bridge and southbound off-ramp flyover, it is anticipated that compared to Option BN-6.1, this option would add an additional year of construction. While there would be minimal impacts to the traveling public, constructing the Route 25 southbound off-ramp flyover under the relocated Route 25 mainline would increase construction complexity and staging challenges.

*Multi-Modal Connections Rating: Favorable*

It is anticipated that connections to the local road network would be provided by shared use path direct connections to Belmont Circle and the Canal Service Road (bike path).

*Utility Impacts Rating: Less Favorable*

Utility impacts would include multiple minor gas and water main impacts; minor telecommunication and sewer impacts; relocation of 25 utility poles, overhead wires, and other multiple minor electrical impacts. This option also has an increased likelihood of substantial impacts to the existing 72-inch drainage conduit that leads to the outfall of the Route 28 drainage system, as well as other minor drainage impacts.



Sections 9.4.1 and 9.4.2 discuss MassDOT’s decisions to advance or dismiss the Bourne South crossing highway interchange options for a secondary evaluation.

#### **9.4.1 OPTIONS ADVANCED FOR FURTHER EVALUATION**

##### 9.4.1.1 Option BS-2

Option BS-2 replaces the existing Bourne Rotary with a grade separated diamond interchange. The relocated Route 25/Route 28 spans over the reconfigured Trowbridge Road. Local connections from Route 25/Route 28 are made via slip ramps connecting to Trowbridge Road. Option BS-2 provides a two-way frontage road west of Route 28 southbound at an intersection with Trowbridge Road, providing local access to businesses that are currently accessed only from existing Route 28 southbound. Figure 9-6 shows a conceptual layout of Option BS-2.



Figure 9-6. Bourne South Crossing Interchange Approach Option BS-2



#### *Operations, Connectivity and Safety Ratings: Most Favorable*

By providing direct access to and from Route 25/28 in both the northbound and southbound directions, it would improve the quality and number of existing connections. Additionally, this option would maintain local traffic connections to and from Sandwich Road and Trowbridge Road. Option BS-2 would provide improved operations for all major movements within the Program Study Area. Additionally, engineering assessments and safety modeling indicate that there would be a substantial reduction in predicted crashes primarily due to the elimination of the Bourne Rotary.

#### *Geometrics Rating: Favorable*

This option would meet current MassDOT and FHWA design standards. It would allow for bi-directional flow on Frontage Road for access to and from Trowbridge Road. However, the northbound off-ramp would require a 15-foot excavation to meet the proposed relocated Trowbridge Road grade.

#### *Constructability Rating: Favorable*

Because of the relative simplicity of this proposed interchange configuration and the ability to construct much of it outside of the existing roadway footprints, the complexity of construction would be minimized. Further, there would be minimal impacts to the traveling public during construction.

#### *Multi-Modal Connections Rating: Favorable*

It is anticipated that connections to the local road network would be provided by shared use path direct connections to Trowbridge Road westbound and the Canal Service Road (bike path).

#### *Utility Impacts Rating: Neutral*

Utility impacts would include gas impacts consisting of one 12-inch HP impact and multiple minor impacts; multiple minor water main impacts; telecommunication impacts including several impacts to a duct bank and other minor impacts; relocation of 31 utility poles, overhead wires, and other multiple minor electrical impacts; and minor drainage impacts.

#### *Environmental Impacts Rating: Less Impactful*

Based on conceptual level development, this option would result in minor to no areas of wetland impacts.

#### *Right-of-Way Impacts Rating: Least Impactful*

Based on conceptual design, this option would involve right-of-way impacts in addition to those previously identified for the mainline alignment fully offline inboard location. Option BS-2 would result in one commercial partial impact. The impacts would not directly affect EJ communities or populations.

#### **9.4.1.2 Option BS-2.2**

Option BS-2.2 replaces the existing Bourne Rotary with a grade separated single point interchange configuration. Like Option BS-2, in Option BS-2.2, the relocated Route 25/Route 28 spans over a reconfigured Trowbridge Road. The on and off slip ramps terminate at Trowbridge Road with a central intersection located beneath the relocated Route 25/Route 28 bridge. Like Option BS-2, Option BS-2.2 includes a two-way frontage road west of Route 28 southbound that provides access to local businesses that are currently accessed from existing Route 28 southbound. However, due to the geometry of the turning lanes associated with the central intersection, access to the frontage road from Trowbridge Road may not be feasible. To provide access to this frontage road, a connecting roadway from the southbound on-ramp is provided. Figure 9-7 shows a conceptual layout of Option BS-2.2.

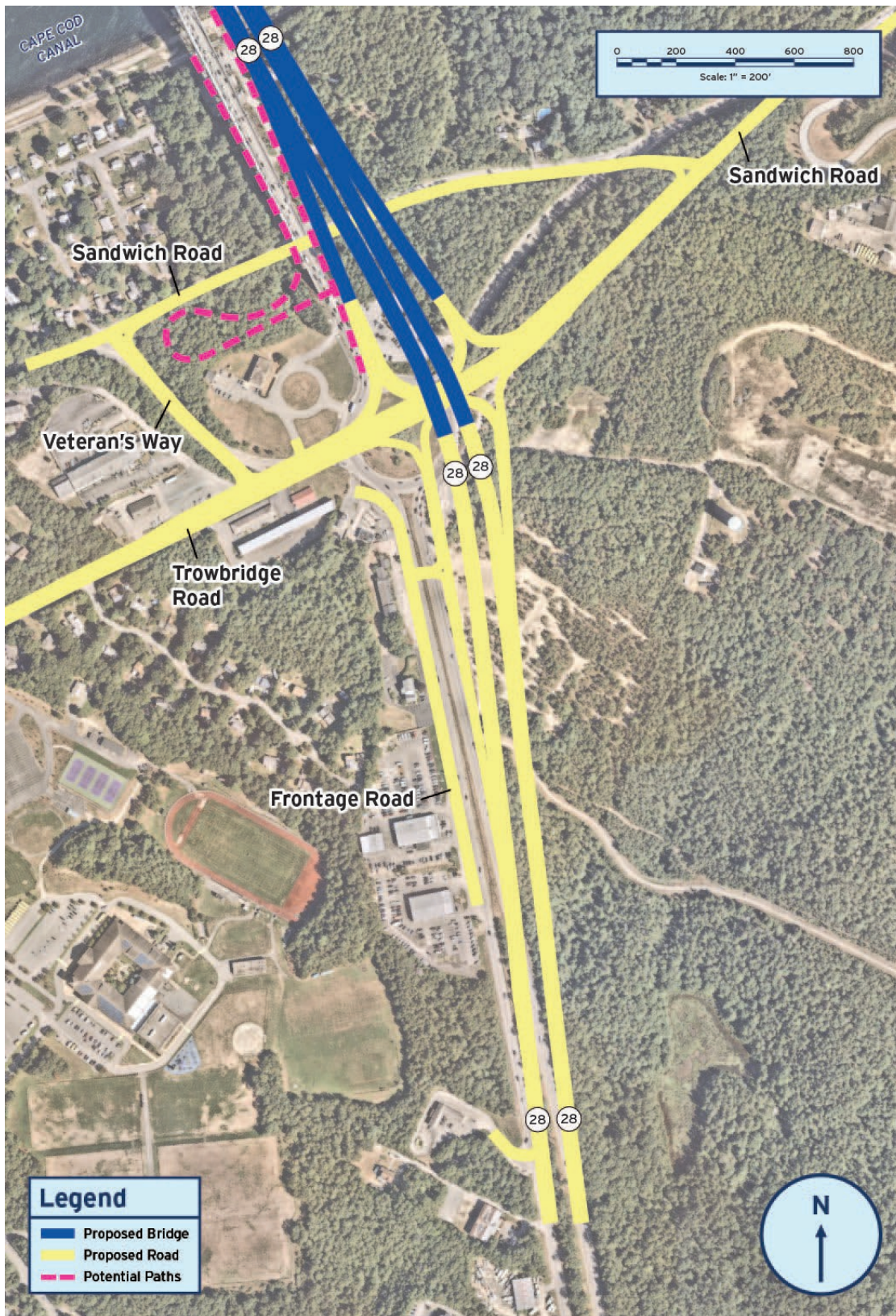


Figure 9-7. Bourne South Crossing Interchange Approach Option BS-2.2

#### *Operations and Safety Ratings: Most Favorable*

Option BS-2.2 would provide improved operations for all major movements within the Program Study Area. Preliminary modeling indicates that the single point interchange would reach near capacity in the future build condition; however, this result is expected to improve as more advanced modeling and traffic analysis are completed. Additionally, future design of this option should evaluate the weave section along the access to Route 25 southbound on-ramp and Frontage Road for additional modifications. Engineering assessments and safety modeling indicate that in Option BS-2.2, there would be a substantial reduction in predicted crashes primarily due to elimination of the Bourne Rotary. Option BS-2.2 would consolidate interchange terminus movements at one signal-controlled intersection vs. two signal-controlled intersections provided in Option BS-2; and the off-ramp curvature would constrain speeds for vehicles merging onto eastbound Sandwich Road.

#### *Connectivity and Geometrics Rating: Favorable*

By providing direct access to and from Route 25/28 in both the northbound and southbound directions, it would improve the quality and number of existing connections. Additionally, this option would maintain local traffic connections to and from Sandwich Road and Trowbridge Road. This option would meet current MassDOT and FHWA design standards. It would maintain the existing access points to Frontage Road. However, the northbound off-ramp would require a 15-foot excavation to meet the proposed grade of relocated Trowbridge Road.

#### *Constructability Rating: Favorable*

Because of the relative simplicity of this proposed interchange configuration and the ability to construct much of it outside of the existing roadway footprints, the complexity of construction would be minimized. Further, there would be minimal impacts to the traveling public during construction.

#### *Multi-Modal Connections Rating: Favorable*

It is anticipated that connections to the local road network would be provided by shared use path direct connections to Trowbridge Road westbound and the Canal Service Road (bike path).

#### *Utility Impacts Rating: Neutral*

This option would incur the same impacts as Option BS-2. Utility impacts would include multiple minor gas and water main impacts; telecommunication impacts including several impacts to a 12-foot-4-inch duct bank and other minor impacts; relocation of 31 utility poles, overhead wires, and other multiple minor electrical impacts; and minor drainage impacts.

#### *Environmental Impacts Rating: Less Impactful*

Based on conceptual level development, this option would result in minor to no areas of wetland impacts.

#### *Right-of-Way Impacts Rating: Least Impactful*

Based on conceptual design, this option would involve right-of-way impacts in addition to those previously identified for the mainline alignment fully offline inboard location. Option BS-2.2 would result in one commercial partial impact. The impact would not directly affect EJ communities or populations.

## **9.4.2 OPTIONS DISMISSED FOR FURTHER EVALUATION**

### **9.4.2.1 Option BS-6.1**

Option BS-6.1 is based upon a partial cloverleaf configuration with most ramps relocated south of the relocated Trowbridge Road. In this option, the southbound off-ramp exits from the relocated Route 25/28 before crossing the relocated Trowbridge Road on an independent structure. Once across Trowbridge Road, it enters a compact loop before terminating at a “peanut” roundabout intersection. The northbound on-ramp uses a similar loop configuration located south of Trowbridge Road before crossing over Trowbridge Road and merging with the Route 25/28 roadway. In addition to an eastbound to northbound exit from Trowbridge Road, Option BS-6.1 provides direct access to the northbound off-ramp from Sandwich Road. This access intersects with the northbound off-ramp at an at-grade intersection after passing over a depressed Trowbridge Road. Frontage Road also serves as the southbound on-ramp with a merge condition at the southern end of Frontage Road. Figure 9-8 shows a conceptual layout of Option BS-6.1.



Figure 9-8. Bourne South Crossing Interchange Approach Option BS-6.1

#### *Operations, Connectivity and Geometrics Ratings: Neutral*

While it would provide good connections to the relocated Bourne Bridge for both Route 28 northbound and southbound traffic and bi-directional access to Frontage Road via the peanut roundabout, this option would require revising Sandwich Road to a partial one-way roadway, resulting in less connectivity for local eastbound traffic. Regarding operations, Option BS-6.1 would have acceptable levels of service at all intersections/ roundabouts except for the Route 25 southbound off-ramp; modeling indicates that the southbound off-ramp would experience substantial queues at the approach to the peanut roundabout. Future design of the option would need to evaluate the necessity of an additional lane along the approach which would impact Frontage Road. While Option BS-6.1 would meet current MassDOT and FHWA design standards, there are two caveats regarding geometrics. The direct connection ramps would create wayfinding issues for both local and regional traffic. Additionally, the southbound off-ramp geometry could require a two-lane off-ramp: entering the peanut roundabout with two lanes would not provide the adequate decision sight distance and could cause queuing problems due to gap acceptance issues within the peanut roundabout.

#### *Safety Rating: Favorable*

Engineering assessments and safety modeling indicate that there would be a substantial reduction in predicted crashes primarily due to elimination of the Bourne Rotary. Additionally, the roundabout would contribute to reductions in predicted crashes. However, the complicated wayfinding and multiple decision points in a small area could contribute to additional crashes. Further, the traffic signal-controlled ramp intersection located east of Route 28 would likely contribute to additional crashes.

#### *Constructability Rating: Unfavorable*

Multiple construction stages would be required to construct the proposed northbound on- and off-ramp structures, creating a level of construction complexity. Additionally, substantial impacts to traveling public would be expected in Option BS-6.1 due to multiple detours required for eastbound and westbound movements to avoid the peanut roundabout construction. Compared to Options BS-2 and BS-2.2, Option BS-6.1 would incur an additional construction duration of at least one year.

#### *Multi-Modal Connections Rating: Neutral*

It is anticipated that connections to the local road network would be provided by shared use path direct connections to Trowbridge Road and the USACE Canal Service Roads (bike path). A drawback of this configuration would be the likelihood that the shared use path would follow the interior of the loop ramp configuration, requiring the path to cross through the intersection of the ramp and the local road.

#### *Utility Impacts Rating: Neutral*

This option would incur approximately the same impacts as Options BS-2 and BS-2.2. Utility impacts would include multiple minor gas impacts; minor water main impacts; telecommunication impacts including several impacts to a 12-foot-4-inch duct bank and other minor impacts; relocation of 31 utility poles, overhead wires, and other multiple minor electrical impacts; and minor drainage impacts.

#### *Environmental Impacts Rating: Less Impactful*

Based on conceptual level development, this option would result in minor to no areas of wetland impacts.

#### *Right-of-Way Impacts Rating: Less Impactful*

Based on conceptual design, this option would involve right-of-way impacts in addition to those previously identified for the mainline alignment fully offline inboard location. Option BS-6-1 would result in one commercial property full acquisition and three commercial partial property impacts. The impacts would not directly affect EJ communities or populations. Additionally, this option would substantially impact driveway access to the State Police Barracks.

#### 9.4.2.2 Option BS-9

Option BS-9 replaces the existing Bourne Rotary with a roundabout, where northbound and southbound Route 25 intersect with Trowbridge Road at a two-lane roundabout. Option BS-9 provides a separate southbound off-ramp for vehicles continuing eastbound on Sandwich Road. This ramp loops around the existing State Police Barracks property before merging into Sandwich Road. Eastbound Sandwich Road splits after it passes under the relocated Route 25/28 mainlines, with one lane connecting with Trowbridge Road at an-grade signalized intersection, while the other lane crosses under Trowbridge Road before merging with Sandwich Road prior to the Technical High School driveway. Option BS-9 provides a frontage road near the existing Route 28 southbound roadway alignment to provide access to local businesses. Figure 9-9 shows a conceptual layout of Option BS-9.

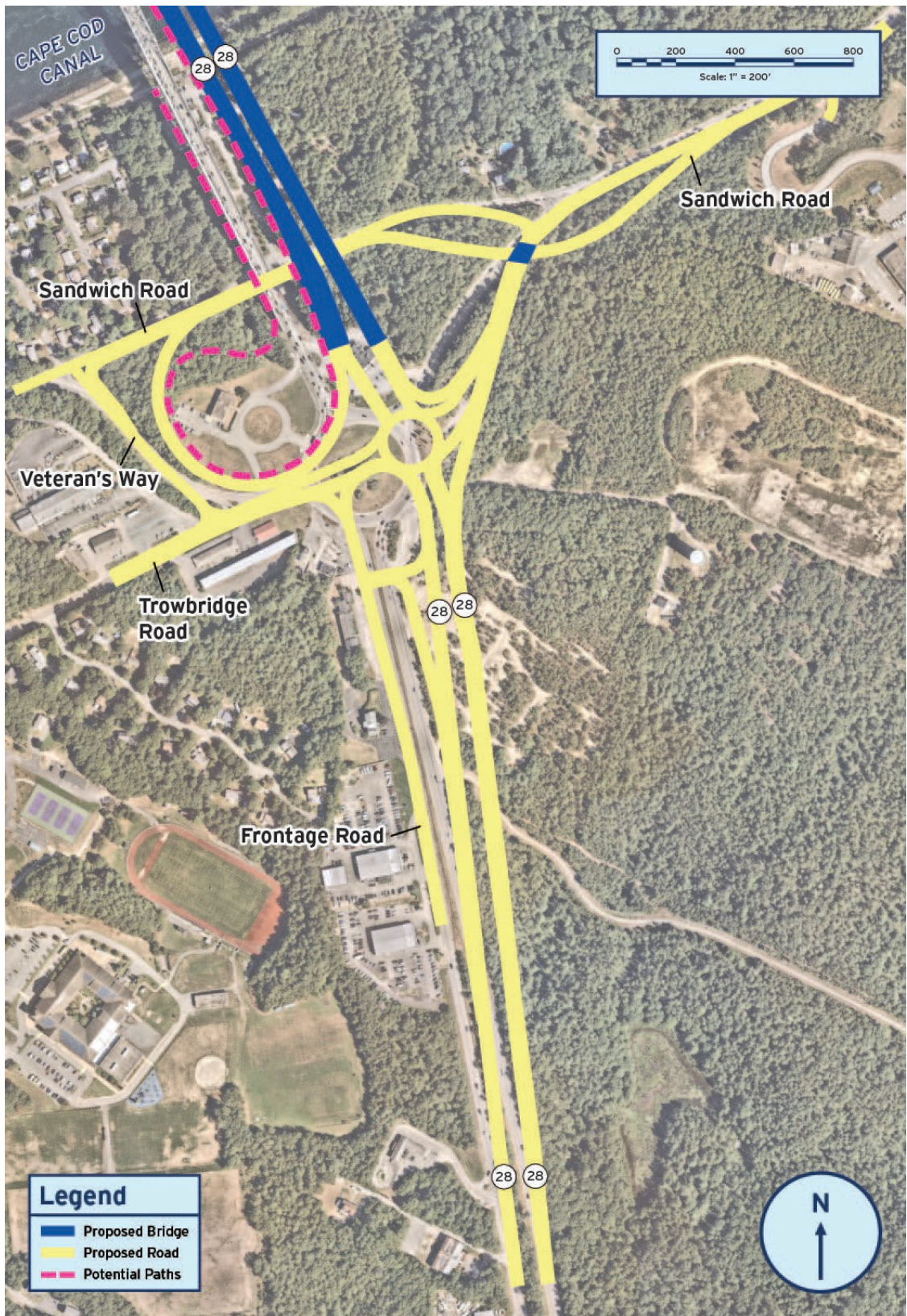


Figure 9-9 Bourne South Crossing Interchange Approach Option BS-9



*Operations Rating: Less Favorable*

Operations modeling indicates that the roundabout would operate above capacity mainly due to substantial northbound and southbound through movements that do not bypass the roundabout.

*Connectivity Rating: Favorable*

This option would provide good connections to the relocated Bourne Bridge with circulation via a roundabout. Additionally, it would provide eastbound and westbound local traffic connectivity using either Sandwich Road or Trowbridge Road, and the Route 25 southbound off-ramp movement to Sandwich Road eastbound would bypass the terminus roundabout.

*Geometrics Rating: Neutral*

This option would meet current MassDOT and FHWA design standards. The southbound off-ramp would be designed to meet a minimum design speed of 30 MPH. However, the Sandwich Road connector would create a depressed “boat” section as it approaches and crosses under Trowbridge Road. This “boat” section of roadway would be well below existing grades, thereby likely requiring retaining walls on both sides of the roadway. Additionally, this depressed section of roadway would prove problematic for drainage and would potentially require a pump station to allow the roadway to drain properly. It should also be noted that constructing the roundabout to meet Route 25/28 at-grade would require raising the roundabout approximately twenty to thirty feet over the existing roadway.

*Safety Rating: Neutral*

Engineering assessments and safety modeling indicate that slower speeds at a modern roundabout should reduce crashes compared to future conditions at the existing Bourne Rotary (No-Action condition). However, traffic volumes are forecasted to exceed roundabout capacity, thereby negating the crash reduction effects of a well- functioning roundabout. Congestion-related crashes along Route 25/28, Sandwich Road, and Trowbridge Road were not assessed.

*Constructability Rating: Unfavorable*

Multiple construction stages would be required to raise the roundabout grade while maintaining all ramp connections as well as raising Sandwich Road/Trowbridge Road intersection. The temporary sheeting and fill amounts would add construction complexity to this option. Substantial impacts to traveling public would be expected in Option BS-9 due to multiple detours required for eastbound and westbound movements to avoid the roundabout construction. Compared to Options BS-2 and BS-2.2, Option BS-9 would incur an additional construction duration of at least one year due to complexities with roundabout construction and the Sandwich Road underpass depressed boat section construction.

*Multi-Modal Connections Rating: Neutral*

It is anticipated that connections to the local road network would be provided by a shared use path to the Canal Service Road. It is anticipated that path routing would be fairly circuitous to provide the length necessary to allow the path to descend from the elevation of the canal crossing to the elevation of the path termini.

*Utility Impacts Rating: Neutral*

Utility impacts would include multiple minor gas impacts; minor water main and sewer impacts; telecommunication impacts including several impacts to a 12-foot-4-inch duct bank and other minor impacts; relocation of 20 utility poles and multiple overhead wires; and minor drainage impacts.

*Environmental Impacts Rating: Less Impactful*

Based on conceptual level development, this option would result in minor to no areas of wetland impacts.

*Right-of-Way Impacts Rating: Less Impactful*

Based on conceptual design, this option would involve right-of-way impacts in addition to those previously identified for the mainline alignment fully offline inboard location. Option BS-9 would result in one residential partial property impact, one commercial full property acquisition consisting of an active business, and one commercial partial property impact. The impacts would not directly affect EJ communities or populations.

**9.4.2.3 Option BS-9.1**

Option BS-9.1 proposes the same roundabout configuration as Option BS-9, but it removes the southbound to eastbound loop ramp. In this option, this ramp is replaced with a standard bypass lane. All other movements in Option BS-9.1 are the same as Option BS-9. Figure 9-10 shows a conceptual layout of Option BS-9.1.

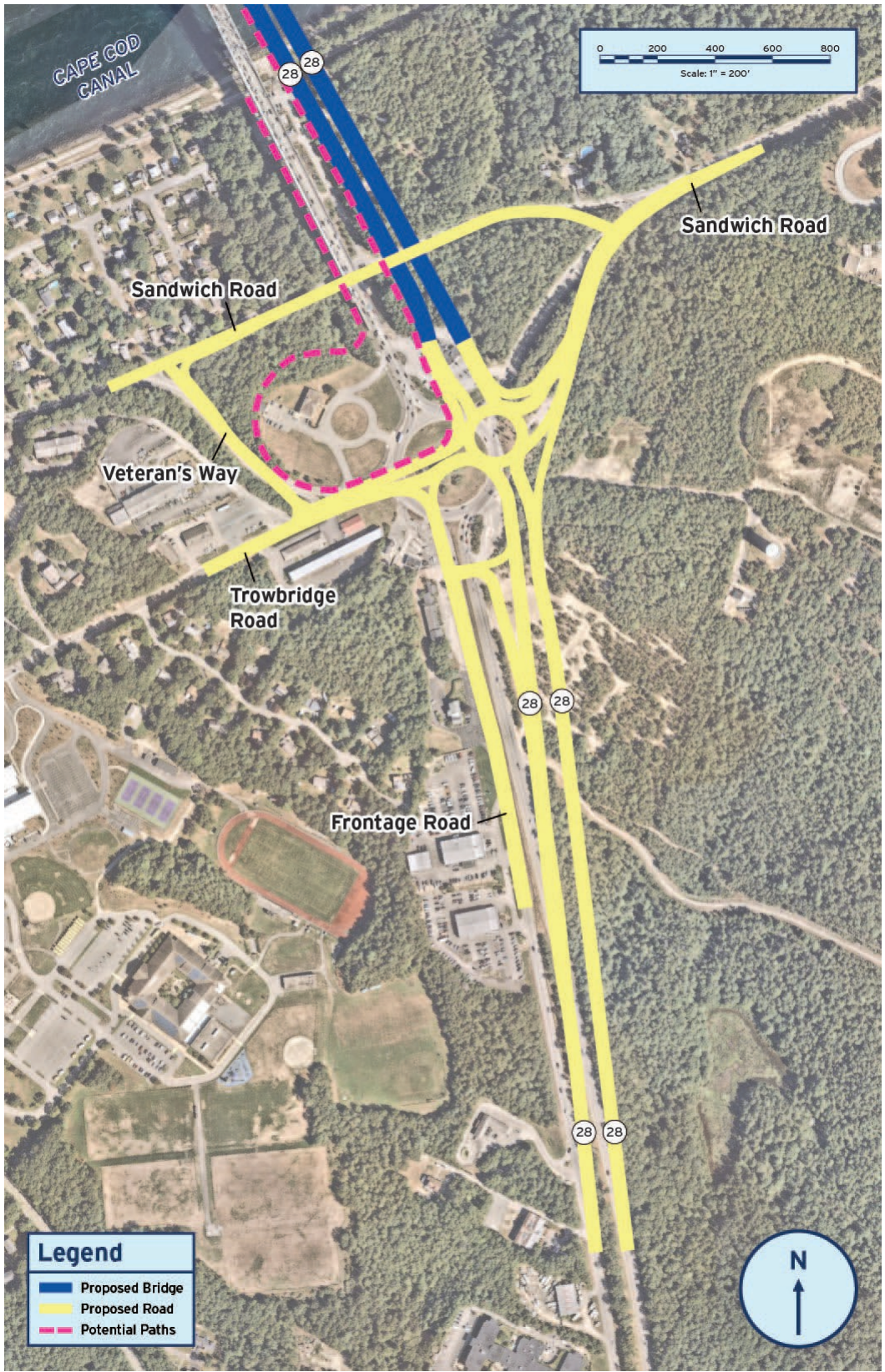


Figure 9-10. Bourne South Crossing Interchange Approach Option BS-9.1

*Operations Rating: Less Favorable*

Operations modeling indicates that the roundabout is expected to operate above capacity mainly due to substantial northbound and southbound through movements which do not bypass the roundabout. Further, traffic from the Route 25 southbound off-ramp movement to Sandwich Road eastbound would circulate through the terminus roundabout which would impede eastbound Trowbridge Road and northbound Route 28 traffic entry into the roundabout.

*Connectivity Rating: Neutral*

Like Option BS-9, Option BS-9.1 would provide good connections to the relocated Bourne Bridge with circulation via a roundabout and eastbound and westbound local traffic has connectivity using either Sandwich Road or Trowbridge Road. However, in Option BS-9.1, the Route 25 southbound off-ramp movement to Sandwich Road eastbound would circulate through the terminus roundabout.

*Geometrics Rating: Favorable*

This option would provide bi-directional flow on Frontage Road for access to and from Trowbridge Road. However, Option BS-9.1 would require raising the elevation of the roundabout by approximately 30 feet over the existing elevation of the rotary.

*Safety Rating: Neutral*

Engineering assessments and safety modeling indicate that slower speeds at a modern roundabout should reduce crashes compared to future conditions at the existing Bourne Rotary (No-Action condition). However, traffic volumes are forecasted to exceed roundabout capacity, thereby negating the typical safety benefits of a well-functioning roundabout. Congestion-related crashes along Route 25/28, Sandwich Road, or Trowbridge Road were not assessed.

*Constructability Rating: Unfavorable*

Multiple construction stages would be required to raise the roundabout grade while maintaining all ramp connections as well as raising Sandwich Road/Trowbridge Road intersection. The temporary sheeting and fill amounts would add construction complexity to this option. Substantial impacts to traveling public would be expected in Option BS-9 due to multiple detours required for eastbound and westbound movements to avoid the roundabout construction. Compared to Options BS-2 and BS-2.2, Option BS-9 would incur an additional construction duration of at least one year due to complexities with elevating grades while maintaining ramp connections as well as raising the Sandwich Road/Trowbridge Road intersection.

*Multi-Modal Connections Rating: Favorable*

It is anticipated that connections to the local road network would be provided by shared use path direct connections to Trowbridge Road and the Canal Service Road (bike path).

*Utility Impacts Rating: Neutral*

Utility impacts would include multiple minor gas impacts; minor water main and sewer impacts; telecommunication impacts including several impacts to a 12-foot-4-inch duct bank and other minor impacts; relocation of 17 utility poles and multiple overhead wires; and minor drainage impacts.

*Environmental Impacts Rating: Less Impactful*

Based on conceptual level development, this option would result in minor to no areas of wetland impacts.

#### *Right-of-Way Impacts Rating: Less Impactful*

Based on conceptual design, this option would involve right-of-way impacts in addition to those previously identified for the mainline alignment fully offline inboard location. Option BS-9.1 would result in one residential partial property impact and two commercial partial property impacts. The impacts would not directly affect EJ communities or populations.

### 9.5 Sagamore North Crossing Interchange Approach Screening Results

For the Sagamore North crossing, MassDOT identified four interchange approach options for modifying the Route 6 westbound/Route 3 northbound off-ramp and conducted a preliminary assessment relative to the highway design evaluation criteria. Modifications largely consist of the realignment of existing ramps to meet the relocated Route 3 alignment. Modifications to the Route 6 eastbound on-ramp and the Route 3 southbound off-ramp and the local roadway network will be developed further as design progresses.

The four approach options would meet current MassDOT and FHWA design standards. At a minimum, the four options receive a favorable safety rating, as all would reduce the predicted crashes and crash rates. The four options receive a favorable utility impacts rating; all options would involve minimal utility impacts limited to relocation of ramp light poles. It is anticipated that none of the four options would involve additional right-of-way impacts other than those impacts previously identified for the mainline alignment fully offline inboard location, as cited in Section 8.4.1. Based on conceptual design, the right-of-way impacts for the four options received a medium impact rating. The four approach options differ regarding operations, connectivity, geometrics, constructability, multi-modal connections, and environmental impacts.

Table 9-3 presents the screening results of the Sagamore North crossing interchange approach options. Based on the conceptual screening, MassDOT is advancing Options SN-1A and SN-8A as Sagamore North crossing interchange approach alternatives to be further evaluated in a Phase 2 alternatives analysis.

Table 9-3. Screening Results of Sagamore North Crossing Interchange Approach Options

Highway Design Evaluation Criteria (1), (2)	SN-1A	SN-3A	SN-4A	SN-8A
Operations	●	●●	●●	●●
Connectivity	●	●●	●●	●●
Geometrics	●	●●	●●	●●
Safety	●●	●●●	●●	●●●
Constructability	●	●●	●●	●
Multi-Modal	●●	●●	●●	●●
Utilities	●●	●●	●●	●●
Environmental	■ ■	■ ■ ■	■ ■ ■	■ ■ ■
Right-of-Way	◇	◇	◇	◇

(1) ●●● Most favorable; ●● Favorable; ● Neutral; ●● Less Favorable; ●● Unfavorable; ●● Not Rated  
 (2) Range of Least to Less Impacts= ■ ■ ■ ■, ■ ■ ■, ■ ■, ■; Medium Impacts= ◇; Range of More to Most Impacts= ■ ■ ■ ■, ■ ■ ■, ■ ■, ■ ■, ■ ■ ■ ■

Sections 9.5.1 and 9.5.2 discuss MassDOT’s decisions to advance or dismiss the Sagamore North crossing highway interchange options for a secondary evaluation.

**9.5.1 OPTIONS ADVANCED FOR FURTHER EVALUATION**

9.5.1.1 Option SN-1A

Option SN-1A mimics the existing interchange ramp configurations and includes the modifications necessary to support the relocated Route 3 alignment. In this option, acceleration and deceleration lane lengths are increased to meet current design standards and improve user safety and operations. In Option SN-1A, State Road is not modified and there is no change to the Route 6 westbound off-ramp loop to Scenic Highway. Figure 9-11 shows a conceptual layout of Option SN-1A.

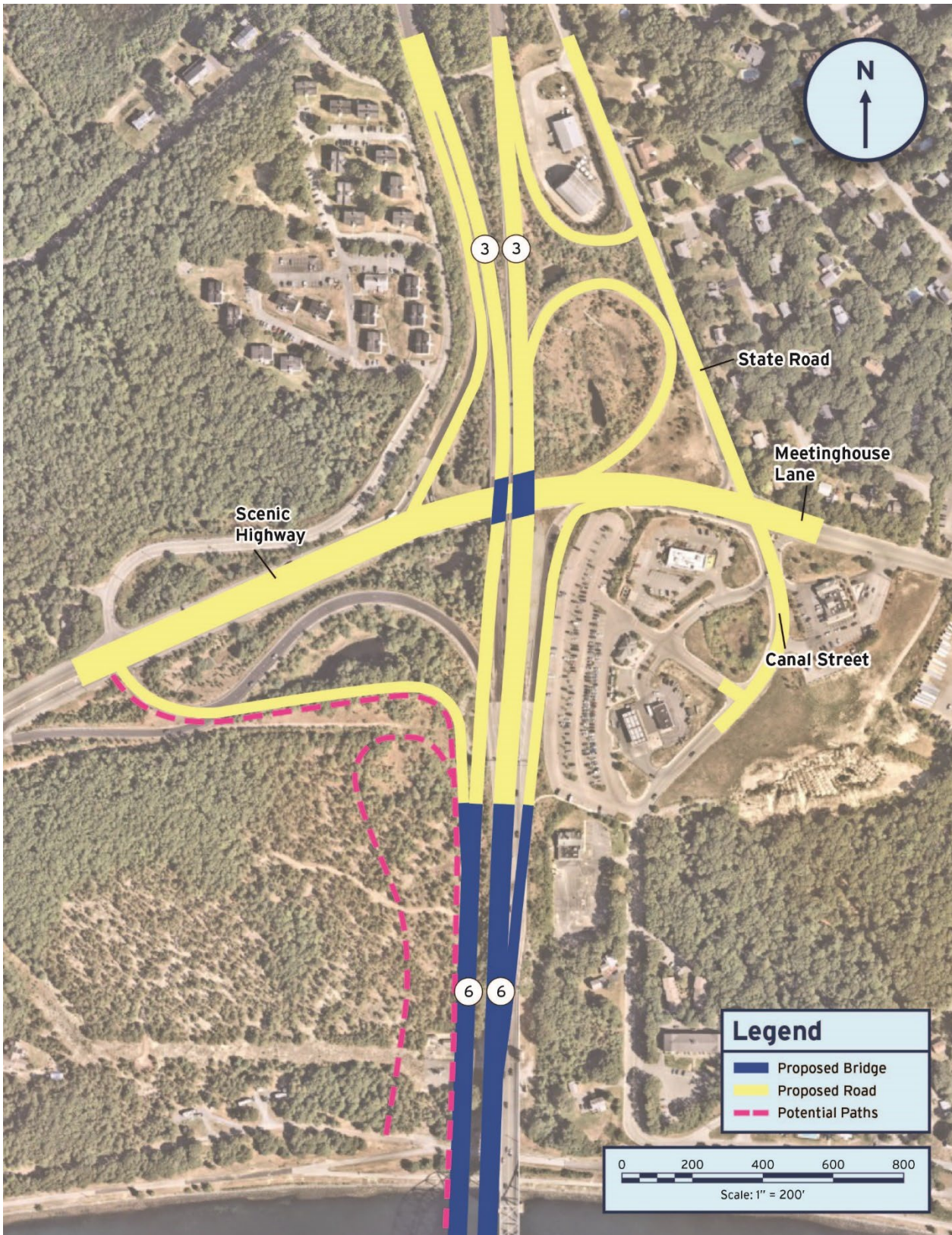


Figure 9-11. Sagamore North Crossing Interchange Approach Option SN-1A

*Operations, Connectivity and Geometrics Rating: Neutral*

In this option, operations would be like the No-Action condition, and existing ramp connections would be maintained. In Option SN-1A, the Route 6 westbound to Meetinghouse Lane eastbound ramp grade would be designed based on a mainline profile raise of four feet to accommodate sea level rise. The Route 6 westbound to Scenic Highway westbound loop ramp would be designed to meet a minimum design speed of 25 MPH.

*Safety Rating: Favorable*

Engineering assessments and safety modeling indicate that due to the geometric and cross-section improvements, there would be a moderate reduction in both the predicted number of crashes and the predicted crash rates in the areas of the Route 3 acceleration/deceleration lanes.

*Constructability Rating: Neutral*

This option would substantially increase the construction duration compared to other options: the Route 6 westbound off-ramp to Meetinghouse Lane could not be completed until both barrels of the replacement are completed, and the existing Sagamore Bridge could not be demolished until new off-ramp is completed. The required construction sequence could add a scheduling complication to this option. Option SN-1A would involve minor impacts to existing traffic. Except for the Route 6 westbound off-ramp to Meetinghouse Lane, which would be difficult to construct since it would cross existing Route 6 traffic, this option would not have construction complexities. A temporary connection to State Road could be required for a short duration.

*Multi-Modal Connections Rating: Less Favorable*

It is anticipated that connections to the local road network would be provided by a shared use path connection to the USACE Canal Service Road bike path). Based on conceptual design, this option would not allow for additional bicycle/pedestrian accommodations along State Road without substantial right-of-way impacts.

*Utility Impacts Rating: Favorable*

This option would involve minimal utility impacts limited to relocation of multiple ramp light poles.

*Environmental Impacts Rating: Neutral*

In this option, the relocation of the Route 3 southbound off-ramp would extend into the Herring River Watershed ACEC within the highway layout and in areas previously disturbed by highway construction. Additionally, Option SN-1A would impact non-jurisdictional storm water basins.

*Right-of-Way Impacts Rating: Medium*

This option would not involve additional right-of-way impacts other than those impacts previously identified for the mainline alignment fully offline inboard location.

**9.5.1.2 Option SN-8A**

Option SN-8A is like the configurations of Options SN-1A and SN-3A. Option SN-8A introduces a variation to the existing interchange by providing a single exit point from a relocated Route 3. Option SN-8A relocates the northbound to eastbound off-ramp movement and eliminates the northbound to eastbound slip ramp. In Option SN-8A, vehicles exiting Route 3 northbound and continuing to State Road or Meetinghouse Lane cross over Scenic Highway/Meetinghouse Lane before turning easterly to connect directly to State Road. In Option SN-8A, State Road is widened to the west, which allows for



further improvements to the ramp geometry and State Road. Figure 9-12 shows a conceptual layout of Option SN-8A.

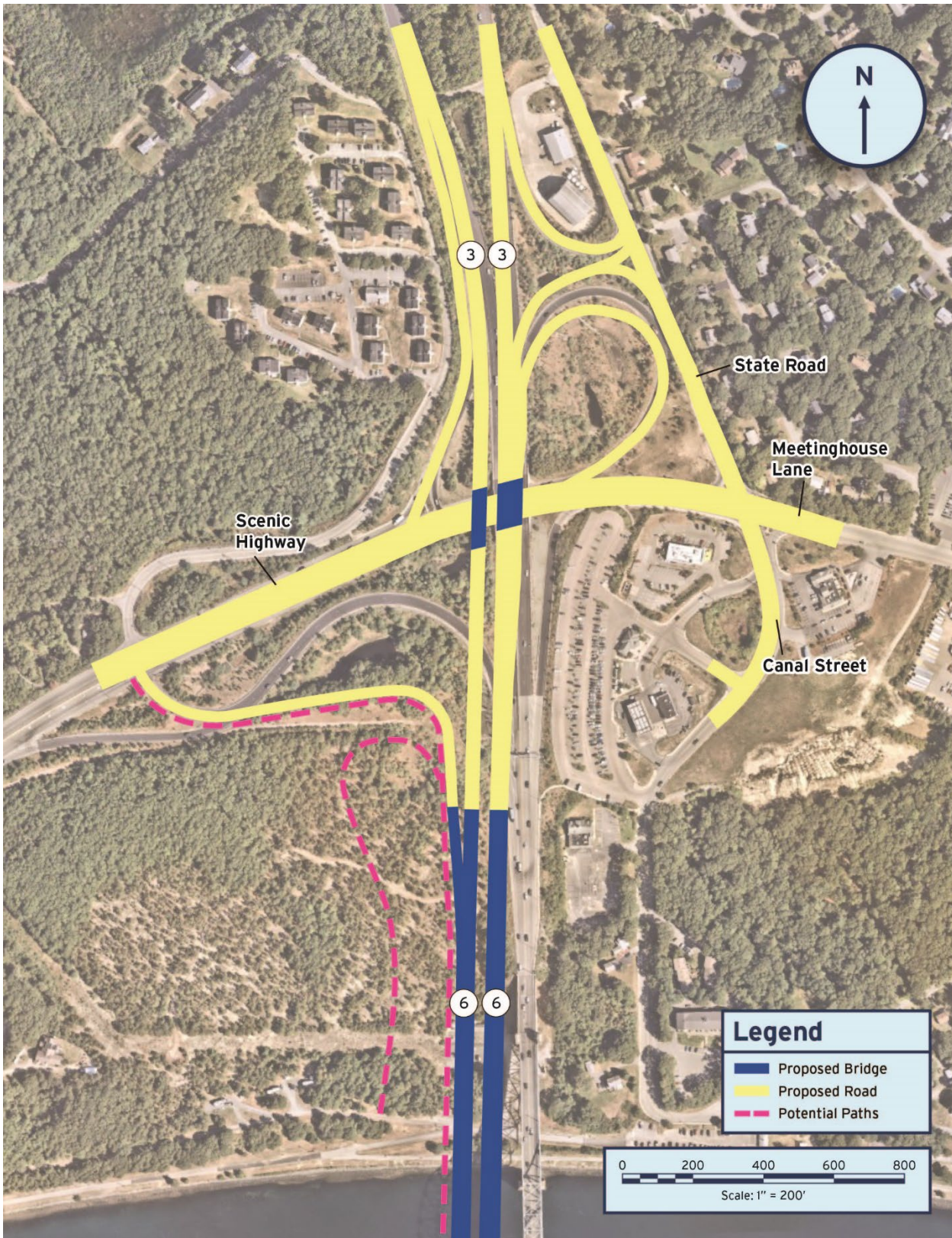


Figure 9-12. Sagamore North Crossing Interchange Approach Option SN-8A

*Operations, Connectivity and Geometrics Rating: Favorable*

By eliminating the Route 6 westbound off-ramp to Scenic Highway eastbound connection, Option SN-8A provides a more direct connection for local State Road traffic, and it eliminates the weave for Route 3 northbound off-ramp traffic destined for State Road northbound. Additionally, Option SN-8A maintains the loop ramp for Route 6 westbound to Scenic Highway westbound traffic. Operations modeling indicates that Option SN-8A would result in acceptable operations at the State Road/Route 3 northbound ramps intersection with minimal queueing on the off-ramp. In Option SN-8A, there would be reduced demand at the Meetinghouse Lane/Canal Street/State Road intersection. While Option SN-8A would meet current MassDOT and FHWA design standards, it would have a tight loop ramp geometry for the Route 6 westbound to Scenic Highway westbound traffic. Additionally, to achieve the minimum 1,000-foot ramp length, a barrier separation between the ramp and Route 6 westbound would be required.

*Safety Rating: Favorable*

Engineering assessments and safety modeling indicate that due to the geometric and cross-section improvements, there would be a moderate reduction in both the predicted number of crashes and the predicted crash rates in the areas of the Route 3 acceleration/deceleration lanes. Additionally, there would be a minimal reduction in the predicted crash rate on ramp roadways and a reduction in the predicted number of crashes on Scenic Highway.

*Constructability Rating: Neutral*

This option would add construction complexity: it would require the initial construction of the new Route 6 westbound off-ramp adjacent to the existing ramp, with a new signalized intersection and channelized lanes where the ramps meet State Road. Additionally, widening State Road to the west would require construction of a retaining wall. Construction of the new Route 6 westbound off-ramp and the retaining wall would extend the construction schedule. While existing ramp connections could be maintained during construction, there would be minor impacts to existing ramp traffic and State Road traffic due to minor lane shifts during widening and retaining wall construction.

*Multi-Modal Connections Rating: Favorable*

It is anticipated that connections to the local road network would be provided by a shared use path connection to the USACE Canal Service Road (bike path) and on the east side of State Road.

*Utility Impacts Rating: Favorable*

This option would involve minimal utility impacts limited to relocation of utility poles and multiple ramp light poles.

*Environmental Impacts Rating: Less Impactful*

In this option, no direct wetland impacts are anticipated.

*Right-of-Way Impacts Rating: Least Impactful*

This option would not involve additional right-of-way impacts other than those impacts previously identified for the mainline alignment fully offline inboard location.

## **9.5.2 OPTIONS DISMISSED FROM FURTHER EVALUATION**

### **9.5.2.1 Option SN-3A**

Option SN-3A relocates the Route 3 northbound to the Scenic Highway eastbound off-ramp movement and eliminates the northbound to eastbound slip ramp. Like Option SN-8A, Option SN-3A reconfigures the existing interchange to provide a single exit point from a relocated Route 3. In contrast to Option SN-8A, Option 3N-3A does not include changes to State Road and therefore does not include pedestrian or bicyclist improvements to State Road. The movements on the westbound off-ramp to Meetinghouse Lane are accommodated on the new direct connection to State Road. In this option, vehicles exiting Route 3 northbound and continuing to State Road or Meetinghouse Lane cross over Scenic Highway/Meetinghouse Lane before turning easterly to connect directly to State Road. Figure 9-13 shows a conceptual layout of Option SN-3A.

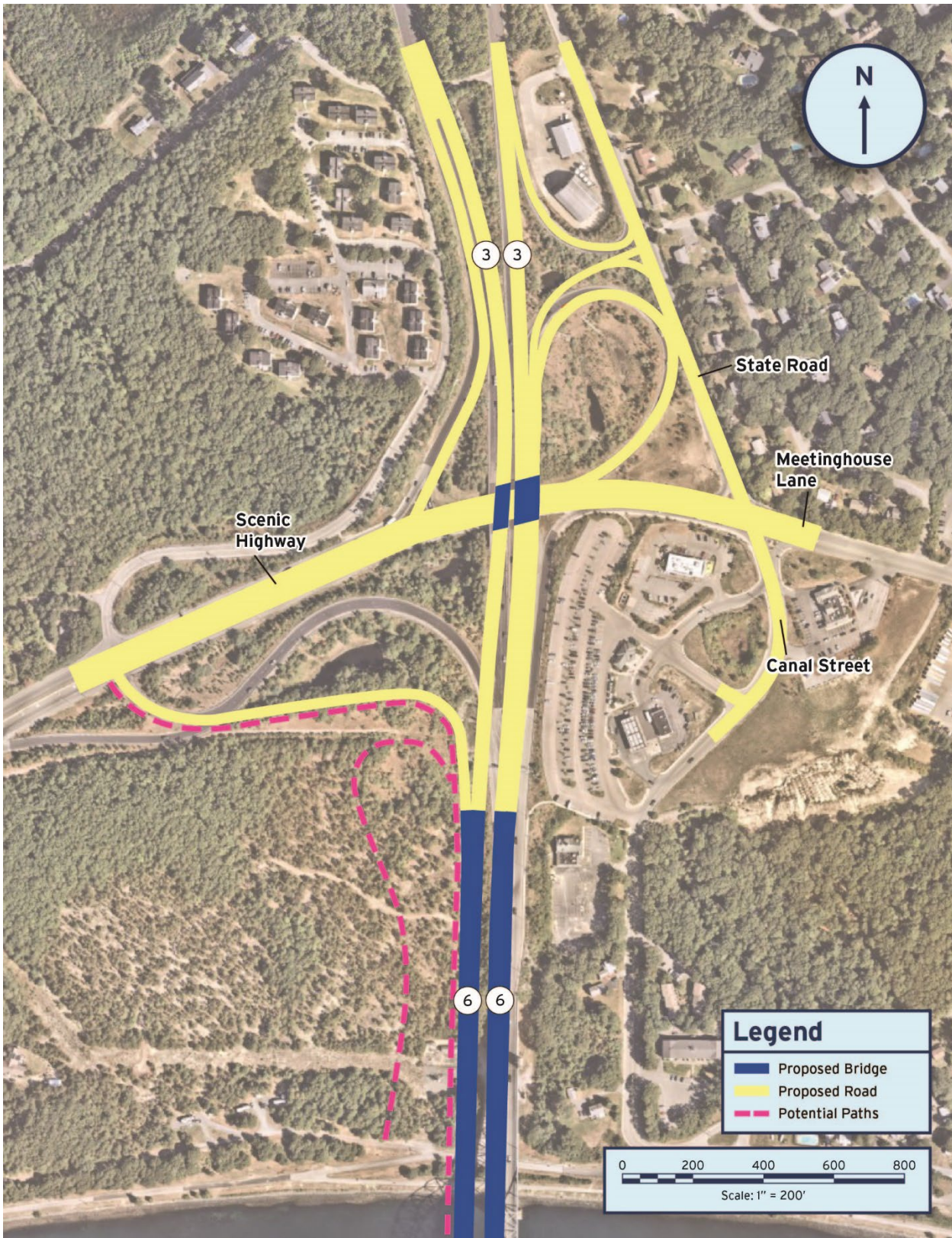


Figure 9-13. Sagamore North Crossing Interchange Approach Option SN-3A

*Operations, Connectivity and Geometrics Rating: Favorable*

By eliminating the Route 6 westbound off-ramp to Scenic Highway eastbound connection, Option SN-3A provides a more direct connection for local State Road northbound traffic, eliminating the weave for Route 6 westbound off-ramp traffic destined for State Road northbound. Additionally, Option SN-3A maintains the loop ramp for Route 6 westbound to Scenic Highway westbound traffic. Operations modeling indicates that Option SN-3A would result in acceptable operations at the State Road/Route 3 northbound ramps intersection with minimal queueing on the off-ramp. In Option SN-3A, there would be reduced demand at the Meetinghouse Lane/Canal Street/State Road intersection. While Option SN-3A would meet current MassDOT and FHWA design standards, it would have a tight loop ramp geometry for the Route 6 westbound to Scenic Highway westbound traffic. Additionally, to achieve the minimum 1,000-foot ramp length, a barrier separation between the ramp and Route 6 westbound would be required.

*Safety Rating: Most Favorable*

Engineering assessments and safety modeling indicate that due to the geometric and cross-section improvements, there would be a moderate reduction in both the predicted number of crashes and the predicted crash rates in the areas of the Route 3 acceleration/deceleration lanes. Additionally, there would be a minimal reduction in the predicted crash rate on ramp roadways and a reduction in the predicted number of crashes on Scenic Highway.

*Constructability Rating: Favorable*

Because the existing Route 6 westbound off-ramp connections could be maintained during construction, Option SN-3A would have an improved ramp construction schedule. Option SN-3A would have minor impacts to existing traffic. However, Option SN-3A would introduce construction complexity: the new Route 6 westbound off-ramps and retaining walls would be constructed adjacent to the existing ramp, and a new signalized intersection and channelized lanes would be constructed where the ramps meet State Road.

*Multi-Modal Connections Rating: Less Favorable*

It is anticipated that connections to the local road network would be provided by a shared use path connection to the USACE Canal Service Road (bike path). Due to space constraints associated with a reduced mainline highway shift compared to other options, it is anticipated that Option SN-3A would not provide additional bicycle and pedestrian accommodations along State Road without substantial right-of-way impacts.

*Utility Impacts Rating: Favorable*

This option would involve minimal utility impacts limited to relocation of multiple ramp light poles.

*Environmental Impacts Rating: Less Impactful*

In this option, no direct wetland impacts are anticipated.

*Right-of-Way Impacts Rating: Medium*

This option would not involve additional right-of-way impacts other than those impacts previously identified for the mainline alignment fully offline inboard location.

#### 9.5.2.2 Option SN-4A

Like Option SN-8A, Option SN-4A reconfigures the existing interchange to provide a single exit point from a relocated Route 3. Option SN-4A eliminates the existing northbound to eastbound slip ramp and relocates the movements to a direct connection to State Road. In this option, the ramp intersects State Road at a roundabout which also provides access to the northbound on-ramp. The northbound off-ramp also provides a loop ramp that bypasses the roundabout with a direct connection to State Road and Scenic Highway/ Meetinghouse Lane. Figure 9-14 shows a conceptual layout of Option SN-4A.

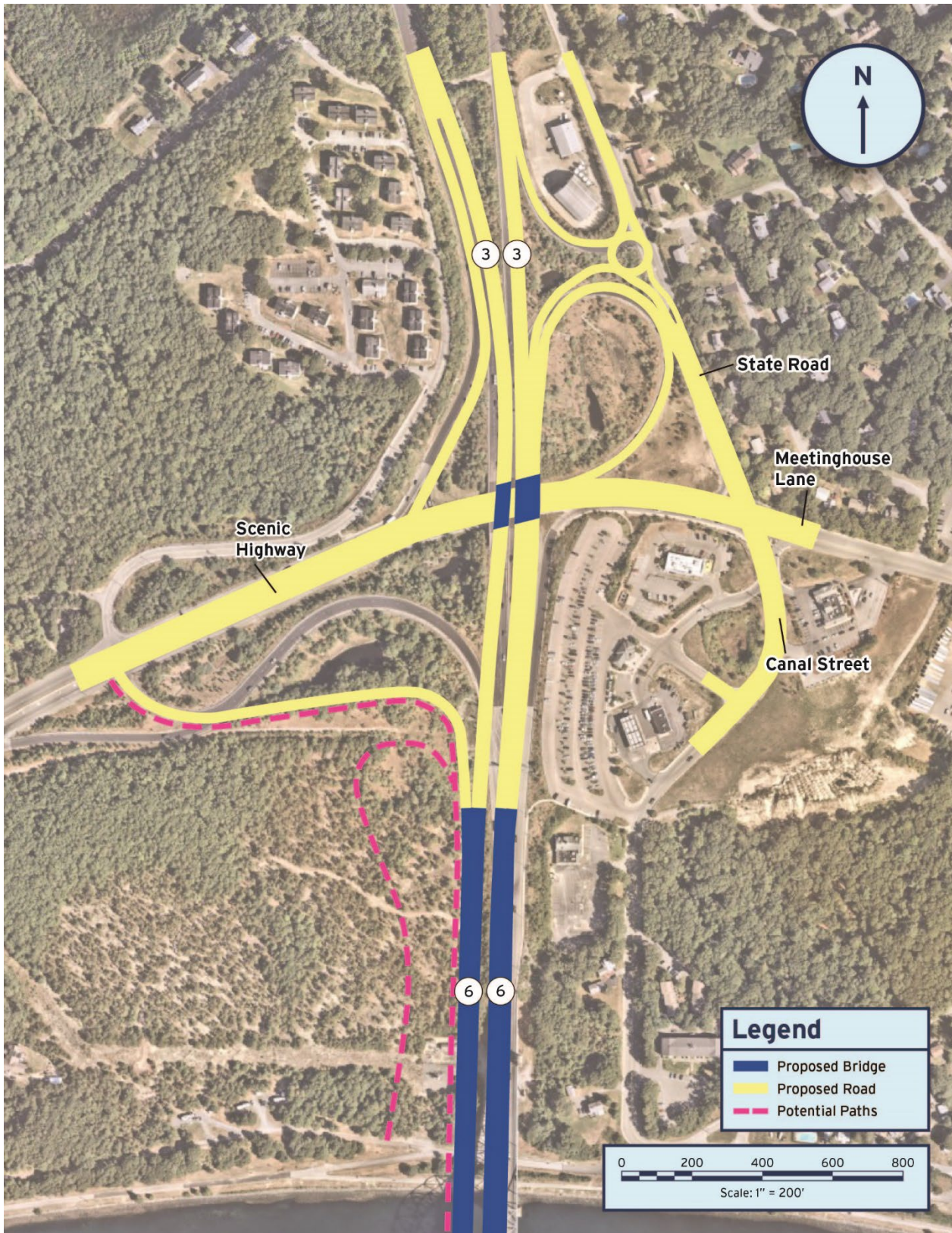


Figure 9-14. Sagamore North Crossing Interchange Approach Option SN-4A



*Operations and Geometrics Rating: Less Favorable*

Operations modeling indicates that the roundabout on State Road at Route 3 northbound ramps would operate acceptably with minimal queues on the off-ramp. However, combining loop ramp traffic with State Road traffic would create a short 200-foot southbound weaving section with high volumes destined for Scenic Highway westbound. The southbound queues on State Road could extend into the weaving section. While Option SN-4A would meet current MassDOT and FHWA design standards, it would have a tight loop ramp geometry for the Route 6 westbound to Scenic Highway westbound traffic. Additionally, to achieve the minimum 1,000-foot ramp length, a barrier separation between the ramp and Route 6 westbound would be required. Further, approximately 400 feet would be available for decision sight distance between the loop ramp and roundabout traffic and the Canal Street intersection, considerably less than the required 720 feet, requiring drivers to make multiple decision points in a limited distance.

*Connectivity Rating: Favorable*

By eliminating the Route 6 westbound off-ramp to Scenic Highway eastbound connection, Option SN-4A directs all traffic to State Road, including the Route 6 westbound to Scenic Highway eastbound traffic.

*Safety Rating: Favorable*

Engineering assessments and safety modeling indicate that due to the geometric and cross-section improvements, there would be a moderate reduction in both the predicted number of crashes and the predicted crash rates in the areas of the Route 3 acceleration/ deceleration lanes. Additionally, there would be a minimal reduction in the predicted crash rate on ramp roadways and a reduction in the predicted number of crashes on Scenic Highway. However, the weaving section on State Road would contribute to additional rear-end/sideswipe crashes.

*Constructability Rating: Less Favorable*

The Route 6 westbound off-ramps and State Road widening would involve extensive retaining wall construction and would be difficult to construct since it would be in the same alignment with the existing off-ramp with major elevation changes. This option would require construction of a temporary Route 6 westbound off-ramp, adding approximately 6 to 12 months to the schedule. Further, the temporary ramp would be needed for an extended duration; the reduced speeds on this high-volume ramp would adversely impact local traffic.

*Multi-Modal Connections Rating: Favorable*

It is anticipated that connections to the local road network would be provided by a shared use path connection to the USACE Canal Service Road (bike path) and on the east side of State Road.

*Utility Impacts Rating: Favorable*

This option would involve minimal utility impacts limited to relocation of utility poles and multiple ramp light poles.

*Environmental Impacts Rating: Less Impactful*

In this option, no direct wetland impacts are anticipated.

*Right-of-Way Impacts Rating: Medium*

This option would not involve additional right-of-way impacts other than those impacts previously identified for the mainline alignment fully offline inboard location.

## 9.6 Sagamore South Crossing Interchange Approach Screening Results

MassDOT identified nine interchange approach options for the Sagamore South Crossing and conducted a preliminary assessment relative to the highway design evaluation criteria. All nine approach options would provide favorable to most favorable multi-modal connections. All options would involve right-of-way impacts in addition to those previously identified for the mainline alignment fully offline inboard location, as cited in Section 8.4.1, resulting in more impactful ratings. With these exceptions, the approach options differ substantially relative to meeting the highway design evaluation criteria.

Table 9-4 presents the screening results of the Sagamore South crossing interchange approach options. Based on the conceptual screening, MassDOT is advancing Options SS-1, SS-1.1, and SS-3.1A as Sagamore South crossing interchange approach alternatives to be further evaluated in a Phase 2 alternatives analysis.

Table 9-4. Screening Results of Sagamore South Crossing Interchange Approach Options

Highway Design Evaluation Criteria (1), (2)	SS-1	SS-1.1	SS-3	SS-3.1	SS-3.1A	SS-3.2	SS-9	SS-9.1	SS-9.1A
Operations	●●	●●	●●	●●	●●	●	●●	●●	●●
Connectivity	●●	●	●●	●	●●	●●	●●●	●●	●●
Geometrics	●	●	●	●●	●●	●	●	●●●	●●
Safety	●●	●●	●●	●●	●●	●●	●●	●●	●●
Constructability	●●	●●	●●	●●●	●●	●●●	●●	●●	●●
Multi-Modal	●●●	●●	●●●	●●●	●●●	●●	●●●	●●	●●
Utilities	●●	●●	●●	●●	●●	●●	●●	●●	●●
Environmental	■ ■	■ ■ ■ ■	■ ■ ■ ■	■ ■ ■ ■	■ ■ ■ ■	■ ■	■ ■ ■ ■	■ ■ ■ ■	■ ■ ■ ■
Right-of-Way	■ ■ ■	■ ■ ■	■ ■ ■	■ ■ ■	■ ■ ■	■ ■	■ ■ ■ ■	■ ■ ■ ■	■ ■ ■ ■

(1) ●●● Most favorable; ●● Favorable; ● Neutral; ●● Less Favorable; ●●● Unfavorable; ●● Not Rated  
 (2) Range of Least to Less Impacts= ■ ■ ■ ■, ■ ■ ■ ■, ■ ■ ■ ■, ■ ■ ■ ■; Medium Impacts= ❖ ; Range of More to Most Impacts= ■ ■ ■ ■, ■ ■ ■ ■, ■ ■ ■ ■, ■ ■ ■ ■

Sections 9.6.1 and 9.6.2 discuss MassDOT’s decisions to advance or dismiss the Sagamore South crossing highway interchange options for a secondary evaluation.

### 9.6.1 OPTIONS ADVANCED FOR FURTHER EVALUATION

#### 9.6.1.1 Option SS-1

Option SS-1 proposes modifications to ramp alignments to accommodate the relocated Route 6 mainline while largely maintaining the existing ramp configurations. The westbound on-ramp and off-ramp movements utilize a diamond type configuration to meet a modified Cranberry Highway. Acceleration and deceleration lanes are lengthened to improve safety and operations along the Route 6 mainline and ramps. The eastbound on-ramp also maintains its existing configuration but features a

lengthened acceleration lane to meet current design standards and improve operations and safety. While the eastbound off-ramp maintains the same general configuration as the existing off-ramp, it shifts approximately 400 feet toward the existing infield area to meet the relocated Route 6 roadway. Option SS-1 also extends Cranberry Highway under Route 6 and continues to the intersection with the Mid-Cape Connector. Figure 9-15 shows a conceptual layout of Option SS-1.



Figure 9-15. Sagamore South Crossing Interchange Approach Option SS-1

#### *Operations and Connectivity Rating: Favorable*

Operations modeling indicates that this option would improve operations at the ramp junctions on Route 6. Additionally, the signalized intersections on the Mid-Cape Connector and Cranberry Highway at the Route 6 westbound ramps would operate acceptably. However, should future build volumes show a large increase in Route 6 westbound ramp traffic, the need for additional turn lanes would need to be evaluated. Option SS-1 would maintain existing ramp connections and the Cranberry Highway Extension (old Factory Outlet Way) would improve access between properties east and west of Route 6.

#### *Geometrics Rating: Neutral*

The eastbound and westbound off-ramps to Cranberry Highway would be designed to meet the maximum desired profile of 6 percent. The westbound on-ramp profile grade would be designed based on a mainline profile raise of four feet to accommodate sea level rise. The westbound off-ramp to Cranberry Highway would be shifted east; however, it would be closer to the Marconi Street neighborhood. Further, the right turn movement for delivery vehicles exiting the Christmas Tree Shop driveway to Cranberry Highway would mimic existing conditions and encroach into the opposite lane of travel on Cranberry Highway.

#### *Safety Rating: Favorable*

Engineering assessments and safety modeling indicate that there would be a moderate reduction in overall predicted crashes and crash rate compared to the No-Action condition. Due to the geometric and cross-section improvements, there would be a moderate reduction in both the predicted number of crashes and the predicted crash rates in the areas of the Route 6 acceleration/ deceleration lanes and ramps. This option would result negligible differences on Sandwich Road and the Mid-Cape Connector.

#### *Constructability Rating: Less Favorable*

In Option SS-1, the construction of ramps and connector roads would consist of a combination of new alignments away from existing traffic and minor widening of existing roadways. This would increase construction complexity. The Route 6 eastbound off-ramp would require a temporary connection to a portion of the Cranberry Highway Extension, but this option would not change the Route 6 westbound off-ramp to Cranberry Highway. Only minor traffic impacts would result from the widening of Sandwich Road, the Mid-Cape Connector and Cranberry Highway Extension. This option would substantially increase the construction duration compared to other options: construction of the Route 6 westbound on-ramp from Cranberry Highway and the Cranberry Highway Extension could not be completed until barrels of the replacement bridge are completed, and the existing Sagamore Bridge could not be demolished until the new Route 6 westbound on-ramp is completed. The required construction sequence could add a scheduling complication to this option.

#### *Multi-Modal Connections Rating: Most Favorable*

It is anticipated that connections to the local road network would be provided by shared use path direct connections to Cranberry Highway, Sandwich Road and the Canal Service Road, including bicycle and pedestrian accommodations along Cranberry Highway and Cranberry Highway Extension.

#### *Utility Impacts Rating: Favorable*

In the option, utility impacts would be limited to the relocation of multiple utility poles, light poles, and overhead wire.

*Environmental Impacts Rating: Less Impactful*

In this option, no direct wetland impacts are anticipated.

*Right-of-Way Impacts Rating: More Impactful*

Based on conceptual design, this option would result in right-of-way impacts in addition to those impacts previously identified for the mainline alignment fully offline inboard location. Option SS-1 would result in two residential full property acquisitions, including two vacant parcels; ten residential partial property impacts, including one vacant parcel; one commercial full property acquisition, consisting of a vacant parcel; and nine commercial partial property impacts. The impacts would not directly affect EJ communities or populations.

**9.6.1.2 Option SS-1.1**

Option SS-1.1 provides the same interchange configuration as Option SS-1, but Option SS-1.1 eliminates the Cranberry Highway Extension. This elimination results in an option that largely mimics the existing interchange configuration with modifications limited to those necessary to match the relocated Route 6 mainline and to provide lengthened acceleration and deceleration lanes. Figure 9-16 shows a conceptual layout of Option SS-1.1.



Figure 9-16. Sagamore South Crossing Interchange Approach Option SS-1.1

#### *Operations Rating: Favorable*

Operations modeling indicates that this option would improve operations at the ramp junctions on Route 6. Additionally, this option would result in acceptable operations at existing intersections with no or minimal changes to lane arrangements.

#### *Connectivity and Geometrics Rating: Neutral*

Option SS-1.1 would maintain existing ramp connections. The geometric conditions of Option SS-1.1 would be like those of Option SS-1. The eastbound and westbound off-ramps to Cranberry Highway would be designed to meet the maximum desired profile of 6 percent. The westbound on-ramp profile grade would be designed based on a mainline profile raise of four feet to accommodate sea level rise. Additionally, the westbound off-ramp to Cranberry Highway would be shifted east, closer to the Marconi Street neighborhood. Further, the right turn movement for delivery vehicles exiting the Christmas Tree Shop driveway to Cranberry Highway would mimic existing conditions and encroach into the opposite lane of travel on Cranberry Highway.

#### *Safety Rating: Favorable*

Engineering assessments and safety modeling indicate that due to the geometric and cross-section improvements, there would be a moderate reduction in both the predicted number of crashes and the predicted crash rates in the areas of the Route 6 acceleration/ deceleration lanes and ramps compared to No-Action conditions. Additionally, crash rates would be reduced slightly on the ramp roadways. This option would result negligible differences on Sandwich Road and the Mid-Cape Connector.

#### *Constructability Rating: Less Favorable*

In Option SS-1.1, the construction of ramps and connector roads would consist of a combination of new alignments away from existing traffic and minor widening of existing roadways. This option would substantially increase the construction duration compared to other options: construction of the Route 6 westbound on-ramp from Cranberry Highway and the Cranberry Highway Extension could not be completed until barrels of the replacement bridge are completed, and the existing Sagamore Bridge could not be demolished until the new Route 6 westbound on-ramp is completed. The required construction sequence could add a scheduling complication to this option. Unlike Option SS-1, which would involve a temporary Route 6 eastbound off-ramp connection to the Cranberry Highway Extension, Option SS-1.1 would not include the Cranberry Highway Extension, eliminating the potential for a temporary Route 6 eastbound off-ramp connection. However, Option SS-1.1 would not be possible without a temporary connection. Like Option SS-1, this option would not change the Route 6 westbound off-ramp to Cranberry Highway. Option SS-1.1 would incur only minor traffic impacts due to the widening of Sandwich Road, the Mid-Cape Connector and Factory Outlet Way.

#### *Multi-Modal Connections Rating: Favorable*

It is anticipated that connections to the local road network would be provided by shared use path direct connections to Sandwich Road and the Canal Service Road, including bicycle and pedestrian accommodations along Cranberry Highway.

#### *Utility Impacts Rating: Favorable*

In this option, utility impacts would be limited to the relocation of multiple utility poles, light poles, and overhead wire.



*Environmental Impacts Rating: Less Impactful*

In this option, no direct wetland impacts are anticipated.

*Right-of-Way Impacts Rating: Impactful*

Based on conceptual design, this option would result in right-of-way impacts in addition to those impacts previously identified for the mainline alignment fully offline inboard location. Option SS-1 would result in two residential full property acquisitions; nine residential partial property impacts, including a vacant parcel; one commercial full property acquisition, consisting of a vacant parcel; and nine commercial partial property impacts. The impacts would not directly affect EJ communities or populations.

**9.6.1.3 Option SS-3.1A**

Option SS-3.1A closely resembles Option SS-1 with one major difference. In Option SS-3.1A, the northbound on-ramp is relocated to begin off the Mid-Cape Connector, so it shares the same entrance point as the southbound on-ramp. From this location, the ramp curves northerly and crosses under Route 6 before merging with the Route 6 northbound roadway. The merge occurs as the northbound on-ramp and Route 6 cross over the Cranberry Highway Extension. Figure 9-17 shows a conceptual layout of Option SS-3.1A.

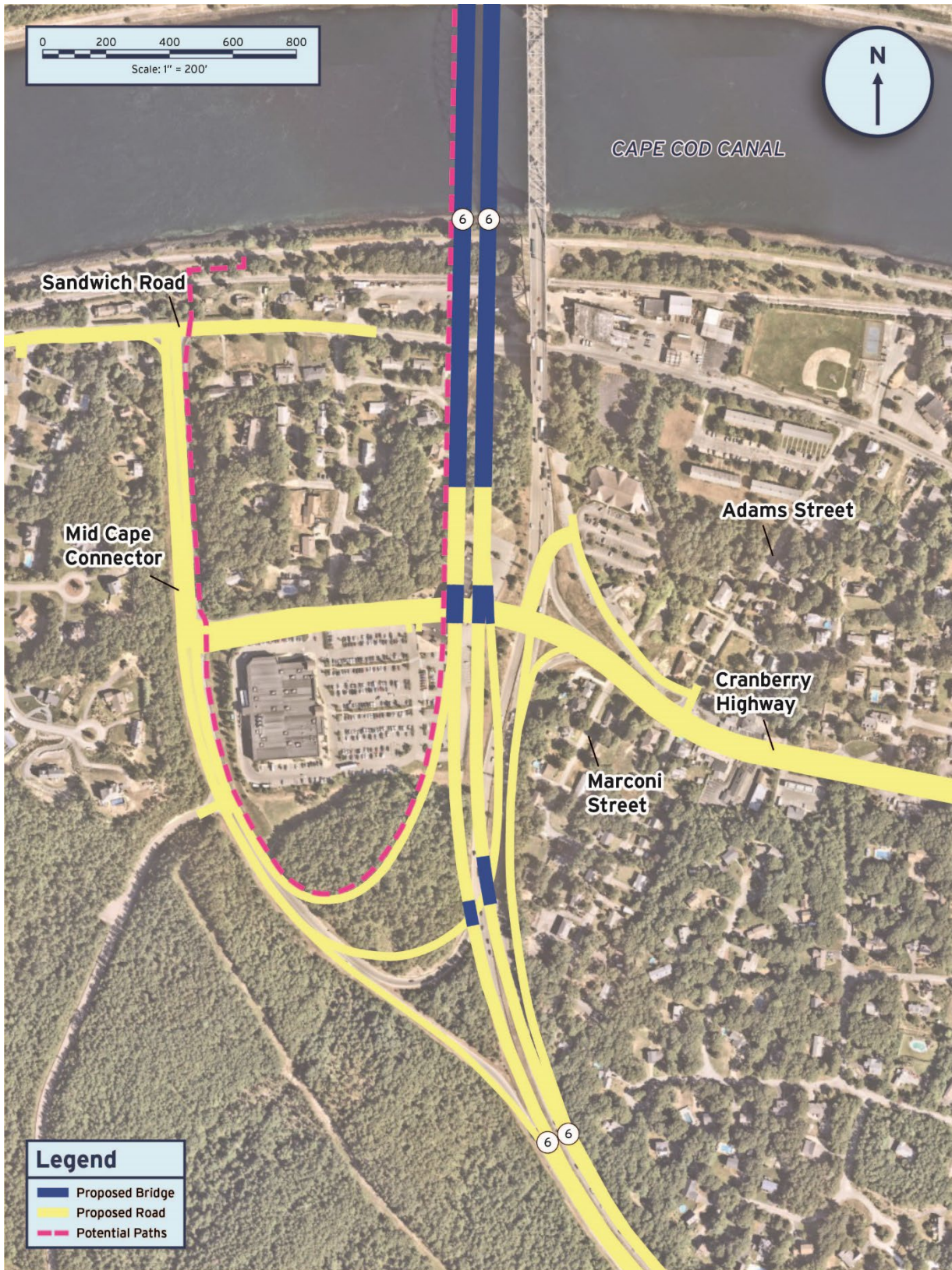


Figure 9-17. Sagamore South Crossing Interchange Approach Option SS-3.1A

*Operations, Connectivity and Geometrics Rating: Favorable*

In Option SS-3.1A, the Cranberry Highway Extension would improve access between properties east and west of Route 6. Additionally, shifting access to Route 6 westbound from east of the roadway to the Mid-Cape Connector would be offset by Cranberry Highway Extension. This option would reduce the length for trips to and from Route 6 eastbound and Route 6A, east of Cranberry Highway. The trip length from Route 6 westbound to Sandwich Road, west of the Mid-Cape Connector, would be reduced by a mile. However, the trip length from Route 6A, east of Cranberry Highway, to Route 6 westbound would increase by over one-half-mile. Operations modeling indicates that Option SS-3.1A would improve operations at the ramp junctions on Route 6. Additionally, the signalized intersections on the Mid-Cape Connector and Cranberry Highway at the Route 6 westbound ramps would operate acceptably.

However, should future build volumes show a large increase in Route 6 westbound ramp traffic, the need for additional turn lanes would need to be evaluated. Option SS-3.1A would meet current MassDOT and FHWA design standards. The eastbound off-ramp would be designed at the maximum desired 6 percent profile grade. Additionally, this option would provide better egress to Cranberry Highway for Christmas Tree Shop delivery vehicles. Further, Option SS-3.1A would eliminate the need for a substantial excavation adjacent to Route 6 westbound.

*Safety Rating: Favorable*

Engineering assessments and safety modeling indicate that due to the geometric and cross-section improvements, there would be a moderate reduction in both the predicted number of crashes and the predicted crash rates in the areas of the Route 6 acceleration/ deceleration lanes and ramps. Additionally, due to the proposed ramp geometry, there would be a moderate reduction in predicted crash rate on ramp segments. This option would result negligible differences on Sandwich Road and the Mid-Cape Connector.

*Constructability Rating: Less Favorable*

The construction of ramps and connector roads would consist of a combination of new alignments away from existing traffic and minor widening to existing roadways. A major portion of the new ramps could be constructed without affecting existing roadways. Unlike Option SS-3.1 (described in Section 8.6.2.2), in Option SS-3.1A, construction of the new Route 6 eastbound off-ramp would not involve deep excavation or construction complexity. The Route 6 eastbound off-ramp would require a temporary connection to a portion of the Cranberry Highway Extension. In Option SS-3.1A, the Cranberry Highway Extension could not be completed until both barrels of the replacement bridge are completed.

Additionally, Cranberry Highway and the signalized intersection for the Christmas Tree Shop could not be built until all Route 6 traffic is relocated on the new bridge structures. The required construction sequence could add a scheduling complication to this option. In this option, only minor traffic impacts would be expected due to the widening of Sandwich Road, the Mid-Cape Connector, and the Cranberry Highway Extension (old Factory Outlet Way).

*Multi-Modal Connections Rating: Most Favorable*

It is anticipated that connections to the local road network would be provided by shared use path direct connections to Cranberry Highway, Sandwich Road and the Canal Service Road, including bicycle and pedestrian accommodations along Cranberry Highway and Cranberry Highway Extension.

*Utility Impacts Rating: Favorable*

In this option, utility impacts would be limited to the relocation of multiple utility poles, light poles, and overhead wire.

*Environmental Impacts Rating: Less Impactful*

In this option, no direct wetland impacts are anticipated.

*Right-of-Way Impacts Rating: More Impactful*

Based on conceptual design, this option would result in right-of-way impacts in addition to those impacts previously identified for the mainline alignment fully offline inboard location. Option SS-3.1A would result in two residential full property acquisitions, including two vacant parcels; ten residential partial property impacts, including one vacant parcel; one commercial full property acquisition, consisting of a vacant parcel; and eight commercial partial property impacts. The impacts would not directly affect EJ communities or populations.

## **9.6.2 OPTIONS DISMISSED FROM FURTHER EVALUATION**

### **9.6.2.1 Option SS-3**

Option SS-3 generally maintains three of the four existing ramp configurations, consisting of the eastbound off-ramp, the eastbound on-ramp, and the westbound off-ramp, with minor modifications to meet current design standards. Option SS-3 shifts the eastbound off-ramp approximately 400 feet into the existing infield area. Option SS-3 relocates the westbound on-ramp to begin off the Mid-Cape Connector. From there, the westbound on-ramp curves northerly as it crosses over the relocated Route 6 mainlines and then continues north before merging with Route 6 westbound. Additionally, Option SS-3 extends Cranberry Highway under Route 6 with its terminus at the Mid-Cape Connector. All ramps provide lengthened acceleration and deceleration lanes to meet current design standards and improve operations and safety. Figure 9-18 shows a conceptual layout of Option SS-3.

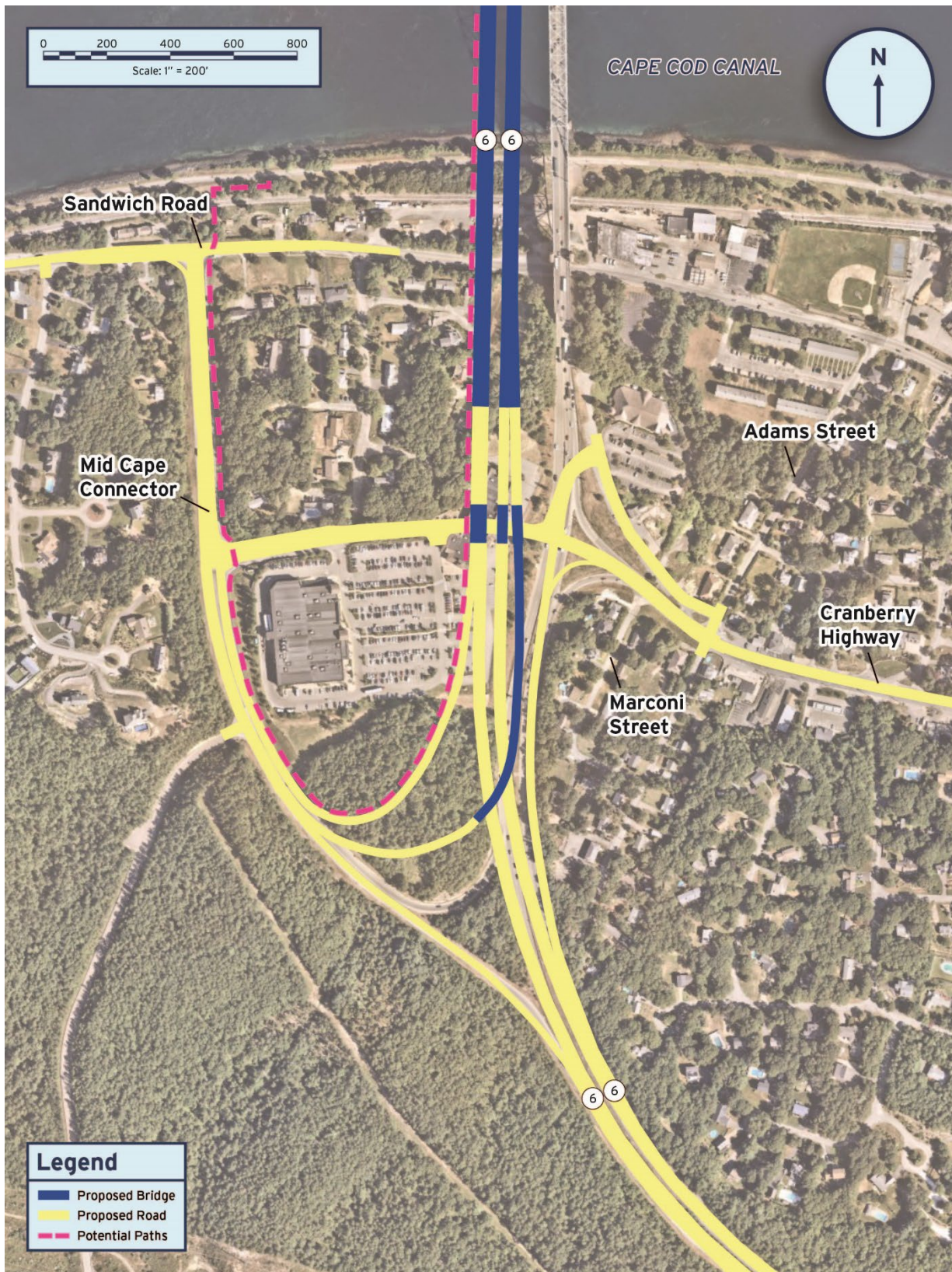


Figure 9-18. Sagamore South Crossing Interchange Approach Option SS-3

#### *Operations and Connectivity Rating: Favorable*

In Option SS-3, all access to and from Route 6 eastbound to Route 6 westbound would be provided from the Mid-Cape Connector, reducing the length for trips to and from Route 6 eastbound and Route 6A, east of Cranberry Highway. The trip length from Route 6 westbound to Sandwich Road, west of Mid-Cape Connector, would be reduced by over one-half-mile. However, Option SS-3 would increase the length for trips to Route 6 westbound from Route 6A, east of Cranberry Highway. Access to and from neighborhoods east of Route 6 would be offset by the Cranberry Highway Extension. Operations modeling indicates that Option SS-3 would improve operations at the ramp junctions on Route 6. Additionally, the signalized intersections on the Mid-Cape Connector and Cranberry Highway at the Route 6 westbound ramps would operate acceptably. However, should future build volumes show a large increase in Route 6 westbound ramp traffic, the need for additional turn lanes would need to be evaluated.

#### *Geometrics Rating: Neutral*

Option SS-3 would meet current MassDOT and FHWA design standards. Both the eastbound off-ramp and the westbound on-ramp would be designed at the desired 6 percent profile grade. Additionally, Option SS-3 would provide better egress to Cranberry Highway for Christmas Tree Shop delivery vehicles compared to other options. However, Option SS-3 would require an elevated ramp structure: the Mid-Cape Connector to Route 6 westbound. The structure's profile grade would approach the maximum desirable grade of 6 percent and span over Route 6, resulting in a high ramp structure adjacent to the Marconi Street neighborhood.

#### *Safety Rating: Favorable*

Engineering assessments and safety modeling indicate that due to the geometric and cross-section improvements, there would be a moderate reduction in both the predicted number of crashes and the predicted crash rates in the areas of the Route 6 acceleration/ deceleration lanes and ramps compared to No-Action conditions. Additionally, crash rates would be reduced slightly on the ramp roadways. This option would result negligible differences on Sandwich Road and the Mid-Cape Connector.

#### *Constructability Rating: Favorable*

In Option SS-3, the construction of ramps and connector roads would consist of a combination of new alignments away from existing traffic and minor widening of existing roadways. A major portion of the new ramps could be constructed without affecting existing roadways. In Option SS-3, completion of the Cranberry Highway Extension would require completion of both barrels of the replacement bridge, potentially adding a scheduling complication to this option.

#### *Multi-Modal Connections Rating: Most Favorable*

It is anticipated that connections to the local road network would be provided by shared use path direct connections to Cranberry Highway, Sandwich Road, and the Canal Service Road, including bicycle and pedestrian accommodations along Cranberry Highway and Cranberry Highway Extension.

#### *Utility Impacts Rating: Favorable*

In this option, utility impacts would be limited to the relocation of multiple utility poles, light poles, and overhead wire.

*Environmental Impacts Rating: Less Impactful*

In this option, no direct wetland impacts are anticipated.

*Right-of-Way Impacts Rating: More Impactful*

Based on conceptual design, this option would result in right-of-way impacts in addition to those impacts previously identified for the mainline alignment fully offline inboard location. Option SS-3 would result in two residential full property acquisitions, including one vacant parcel; ten residential partial property impacts, including one vacant parcel; one commercial full property acquisition, consisting of a vacant parcel; and nine commercial partial property impacts. The impacts would not directly affect EJ communities or populations.

**9.6.2.2 Option SS-3.1**

Option SS-3.1 concentrates all ramp movements to begin and end at the Mid-Cape Connector. The eastbound off-ramp and on-ramp are like the existing ramp configurations, with a 400-foot shift into the infield area to accommodate the relocated Route 6 mainline alignments. However, in Option SS-3, the westbound off-ramp and on-ramp termini are substantially changed from their existing ramp configurations. The westbound on-ramp begins at the terminus of the Mid-Cape Connector and curves northerly as it spans over the westbound off-ramp and then crosses under the relocated Route 6 mainline before merging with Route 6 westbound. The westbound off-ramp exits Route 6 in advance of the interchange and then descends to cross under the Route 6 mainline while curving westerly. The off-ramp then crosses under the westbound on-ramp before terminating at the Mid-Cape Connector. In Option SS-3.1, all ramps provide lengthened acceleration and deceleration lanes to meet current design standards and improve operations and safety. Option SS-3.1 also extends Cranberry Highway to the Mid-Cape Connector by crossing under the relocated Route 6 mainlines. Figure 9-19 shows a conceptual layout of Option SS-3.1.



Figure 9-19. Sagamore South Crossing Interchange Approach Option SS-3.1



#### *Operations and Geometrics Rating: Favorable*

Operations modeling indicates that Option SS-3.1 would improve operations at the ramp junctions on Route 6. Additionally, the signalized intersections on the Mid-Cape Connector would operate acceptably. However, should future build volumes show a large increase in Route 6 westbound ramp traffic, the need for additional turn lanes would need to be evaluated. Additionally, further development of this option would require an evaluation of the Route 6 eastbound and westbound off-ramp traffic weave on the Mid-Cape Connector prior to the Cranberry Highway Extension intersection. Option SS-3.1 would meet current MassDOT and FHWA design standards. The eastbound off-ramp would be designed at the desired 6 percent profile grade. Option SS-3.1 would provide better egress to Cranberry Highway for Christmas Tree Shop delivery vehicles compared to other options. However, construction of the new Route 6 westbound off-ramp to the Mid Cape Connector, located between Route 6 westbound and the existing Route 6 westbound off-ramp, would involve a substantial excavation of up to 35 feet along Route 6.

#### *Connectivity Rating: Neutral*

In Option SS-3.1, all access to and from Route 6 would be provided from the Mid-Cape Connector. This option would reduce the length for trips to and from Route 6 eastbound and Route 6A, east of Cranberry Highway. The trip length from Route 6 westbound to Sandwich Road, west of Mid-Cape Connector, would be reduced by a mile. However, Option SS-3.1 would increase the length for trips to and from Route 6 westbound and Route 6A, east of Cranberry Highway. Access to and from neighborhoods east of Route 6 would be offset by the Cranberry Highway Extension.

#### *Safety Rating: Favorable*

Engineering assessments and safety modeling indicate that due to the geometric and cross-section improvements, there would be a moderate reduction in both the predicted number of crashes and the predicted crash rates in the areas of the Route 6 acceleration/ deceleration lanes and ramps compared to No-Action conditions. Additionally, crash rates would be reduced slightly on the ramp roadways. This option would result negligible differences on Sandwich Road and the Mid-Cape Connector.

#### *Constructability Rating: Unfavorable*

The construction of ramps and connector roads would consist of a combination of new alignments away from existing traffic and minor widening to existing roadways. A major portion of the new ramps could be constructed without affecting existing roadways. The Route 6 eastbound off-ramp would require a temporary connection to a portion of the Cranberry Highway Extension. With a deep cut boat section and deep drainage excavation, the new Route 6 westbound off-ramp would require extensive sheeting, adding construction complexity. Further, the Cranberry Highway Extension and the Route 6 westbound off-ramp could not be completed until both barrels of the replacement bridge are completed. The required construction sequence would add a scheduling complication to this option, adding a minimum of a year to the construction schedule. Only minor traffic impacts would result from the widening of Sandwich Road, the Mid-Cape Connector, and Cranberry Highway Extension (old Factory Outlet Way).

#### *Multi-Modal Connections Rating: Most Favorable*

It is anticipated that connections to the local road network would be provided by shared use path direct connections to Cranberry Highway, Sandwich Road and the Canal Service Road, including bicycle and pedestrian accommodations along Cranberry Highway and Cranberry Highway Extension.

#### *Utility Impacts Rating: Less Favorable*

In addition to the relocation of multiple utility poles, light poles, and overhead wire, in Option SS-3.1, a drainage pump station or deep drainage pipes could be required for the Route 6 westbound on- and off-ramp areas.

#### *Environmental Impacts Rating: Less Impactful*

In this option, no direct wetland impacts are anticipated. However, the deep excavation required for the Route 6 westbound ramp to the Mid-Cape Connector would extend well past the utility corridor.<sup>14</sup> As a result, this alternative would likely have temporary and permanent impacts to the Shawme Crowell State Park and could require relocation of one or more utility towers within the utility corridor. The Shawme Crowell State Park is protected under Article 97<sup>15</sup> and Section 4(f) of the Department of Transportation Act of 1966.<sup>16</sup>

#### *Right-of-Way Impacts Rating: More Impactful*

Based on conceptual design, this option would result in right-of-way impacts in addition to those impacts previously identified for the mainline alignment fully offline inboard location. Option SS-3.1 would result in two residential full property acquisitions, including two vacant parcels; ten residential partial property impacts, including one vacant parcel; one commercial full property acquisition, consisting of a vacant parcel; and eight commercial partial property impacts. The impacts would not directly affect EJ communities or populations.

#### 9.6.2.3 Option SS-3.2

Option SS-3.2 has most of the same features as Option SS-3.1; however, Option SS-3.2 eliminates the Cranberry Highway Extension. Figure 9-20 shows a conceptual layout of Option SS-3.2.

---

<sup>14</sup> The utility corridor carries the high-tension electrical power on three sets of parallel towers from east to west. The open cut area is owned by the Massachusetts Department of Conservation and Recreation (DCR) and leased to the power companies (NGRID). Note that because the utility corridor is kept free of trees, the area provides unique habitat for several state listed species.

<sup>15</sup> Article 97 protection applies to lands acquired by State agencies under the Executive Office of Energy and Environmental Affairs in fee simple or by a Conservation Restriction; these lands are protected under Article 97 of the Amendments to the Massachusetts Constitution and require a two-thirds vote of the State Legislature before they can be disposed of.

<sup>16</sup> Section 4(f) requires the consideration of park and recreation lands, wildlife and waterfowl refuges, and historic sites during U.S. Department of Transportation project development. Before approving a project that uses Section 4(f) property, FHWA must determine that there is no feasible and prudent alternative that avoids the Section 4(f) properties and that the project includes all possible planning to minimize harm to the Section 4(f) properties; or FHWA makes a finding that the project has a de minimis impact on the Section 4(f) property



Figure 9-20. Sagamore South Crossing Interchange Approach Option SS-3.2

*Operations and Geometrics Rating: Neutral*

Operations modeling indicates that Option SS-3.2 would improve operations at the ramp junctions on Route 6. However, additional delays/queues would be expected at Sandwich Road and the Mid-Cape Connector with this now being sole access point to/from Route 6. Should future build volumes show a large increase in Route 6 westbound ramp traffic, the need for additional turn lanes would need to be evaluated. Additionally, further development of this option would require an evaluation of the Route 6 eastbound and westbound off-ramp traffic weave on the Mid-Cape Connector prior to the Market Basket intersection. Option SS-3.2 would meet current MassDOT and FHWA design standards. The eastbound off-ramp would be designed at the desired 6 percent profile grade. However, construction of the new Route 6 westbound off-ramp to the Mid Cape Connector, located between Route 6 westbound and the existing Route 6 westbound off-ramp, would involve a substantial excavation of up to 35 feet along Route 6.

*Connectivity Rating: Less Favorable*

In Option SS-3,2, all access to and from Route 6 would be provided from the Mid-Cape Connector, impacting access to neighborhoods to the east. This option would increase trip lengths to and from Route 6 westbound and Route 6A, east of Cranberry Highway. However, this option would reduce the trip length for Route 6 westbound to Sandwich Road, west of the Mid-Cape Connector, by a mile.

*Safety Rating: Favorable*

Engineering assessments and safety modeling indicate that due to the geometric and cross-section improvements, there would be a moderate reduction in both the predicted number of crashes and the predicted crash rates on Route 6. Additionally, crash rates would be reduced slightly on the ramp segments. This option would result negligible differences on Sandwich Road and the Mid-Cape Connector.

*Constructability Rating: Unfavorable*

from existing traffic and minor widening to existing roadways. A major portion of the new ramps could be constructed without affecting existing roadways. Without the Cranberry Highway Extension, a temporary Route 6 eastbound off-ramp would not be possible, however, Option SS-3.2 would require some type of connection. With a deep cut boat section and deep drainage excavation, the new Route 6 westbound off-ramp would require extensive sheeting, adding construction complexity. Additionally, the Route 6 westbound off-ramp could not be completed until both barrels of the replacement bridge are completed. The required construction sequence would add a scheduling complication to this option, adding more than a year to the construction schedule. Only minor traffic impacts would result from the widening of Sandwich Road and the Mid-Cape Connector.

*Multi-Modal Connections Rating: Favorable*

It is anticipated that connections to the local road network would be provided by shared use path direct connections to Sandwich Road and the Canal Service Road, including bicycle and pedestrian accommodations along Cranberry Highway.

*Utility Impacts Rating: Less Favorable*

Like Option SS-3.1, in addition to the relocation of multiple utility poles, light poles, and overhead wire, in Option SS-3.2, a drainage pump station or deep drainage pipes could be required for the Route 6 westbound on- and of-ramp areas.

*Environmental Impacts Rating: Impactful*

In this option, no direct wetland impacts are anticipated. However, the construction of the Route 6 westbound ramp to the Mid-Cape connector would result in permanent and temporary impacts to the Shawme Crowell State Park. This property is protected under Article 97.

*Right-of-Way Impacts Rating: Impactful*

Based on conceptual design, this option would result in right-of-way impacts in addition to those previously identified for the mainline alignment fully offline inboard location. Option SS-3.2 would result in two residential full property acquisitions; seven residential partial property impacts, including a vacant parcel; one commercial full property acquisition, consisting of a vacant parcel; and one commercial partial property impact. The impacts would not directly affect EJ communities or populations.

**9.6.2.4 Option SS-9**

Option SS-9 uses an elongated modified diamond type configuration to provide westbound off and on-ramp movements as well as the eastbound on-ramp. This option provides a cross-highway connection under Route 6 in the existing overhead utility corridor. In Option SS-9, the westbound off-ramp and on-ramps assume a standard diamond configuration with an intersection at the end of the ramps at a partial roundabout. This roundabout connects to a partial roundabout on the west side of Route 6 via an underpass connecting roadway. The eastbound on-ramp begins at this roundabout and merges with Route 6 eastbound in a standard diamond configuration. The unique aspect of this arrangement is that all access to the diamond portion of the interchange is provided by a two-way frontage road on the west side of Route 6. This frontage road connects to the Mid-Cape Connector Road. The eastbound off-ramp maintains a similar configuration to the existing ramp with an approximate 400-foot shift into the infield area to accommodate the relocated Route 6 mainline alignment. Option SS-9 also extends Cranberry Highway under Route 6, intersecting with the Mid-Cape Connector. Figure 9-21 shows a conceptual layout of Option SS-9.

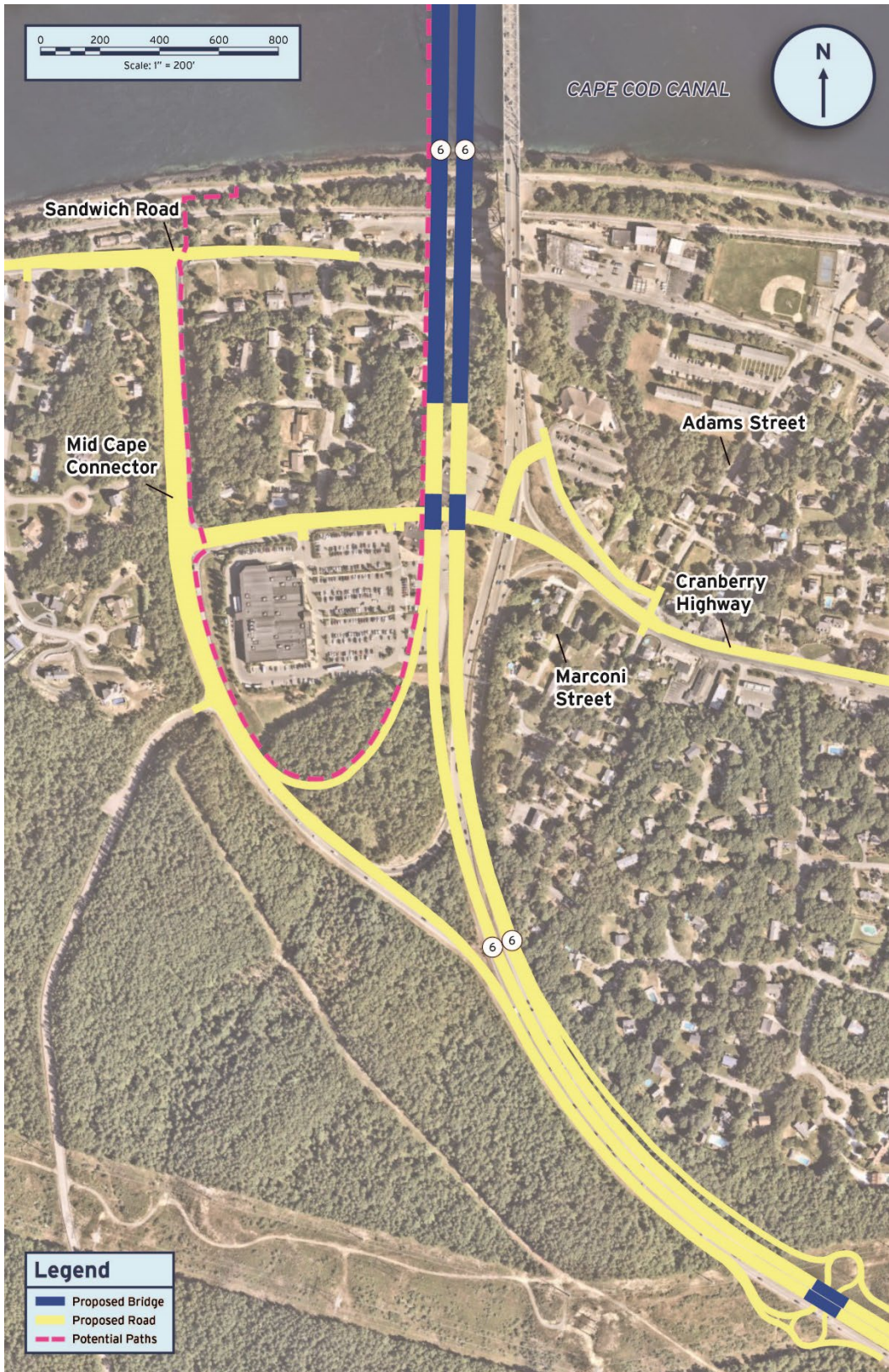


Figure 9-21 Sagamore South Crossing Interchange Approach Option SS-9

#### *Operations Rating: Less Favorable*

Operations modeling indicates that Option SS-9 would improve operations at the ramp junctions on Route 6 and the signalized intersections on the Mid-Cape Connector would operate acceptably. However, high conflicting volumes for traffic entering and exiting Route 6 westbound would result in poor operations at the bottom of the ramps with long queues on the Route 6 westbound off-ramp. Additionally, further development of this option would require an evaluation of the Route 6 eastbound and westbound off-ramp traffic weave on the Mid-Cape Connector prior to the Cranberry Highway Extension intersection.

#### *Connectivity Rating: Unfavorable*

In this option, the Cranberry Highway Extension would improve access to and from Route 6 eastbound and properties east of Route 6. However, the trip length for traffic destined for Route 6 westbound from Route 6A, east of Cranberry Highway would increase by just over 1.5 miles. This option would reduce the lengths of trips to and from Sandwich Road, west of the Mid-Cape Connector and Route 6 westbound, and to and from Route 6A, east of Cranberry Highway and Route 6 eastbound.

#### *Geometrics Rating: Neutral*

Option SS-9 would meet current MassDOT and FHWA design standards. The eastbound off-ramp would be designed at the desired 6 percent profile grade. Additionally, this option would provide better egress to Cranberry Highway for Christmas Tree Shop delivery vehicles. However, construction of the new Route 6 westbound off-ramp to the Mid Cape Connector, located between Route 6 westbound and the existing Route 6 westbound off-ramp, would involve a substantial excavation of up to 35 feet along Route 6.

#### *Safety Rating: Less Favorable*

Engineering assessments and safety modeling indicate that due to the geometric and cross-section improvements, there would be a moderate reduction in both the predicted number of crashes and the predicted crash rates on Route 6. However, the long straight frontage road could encourage faster speeds heading north where the Route 6 eastbound off-ramp meets the Mid-Cape Connector. This option would result a negligible change in predicted crash rates on ramp roadways and negligible differences on Sandwich Road and the Mid-Cape Connector.

#### *Constructability Rating: Less Favorable*

The construction of ramps and connector roads would consist of a combination of new alignments away from existing traffic and minor widening to existing roadways. A major portion of the new ramps could be constructed without affecting existing roadways. The new Route 6 westbound off-ramp and the Route 6 eastbound on-ramp at the utility corridor would require temporary roadways in each direction while both barrels of the replacement bridges are built. The Route 6 eastbound off-ramp would require a temporary connection to a portion of the Cranberry Highway Extension. The Cranberry Highway Extension could not be completed until both barrels of the replacement bridge are completed. Further, the access into the Christmas Tree Shop could not be built until all Route 6 traffic is relocated to the new bridge. The required construction sequence would add a scheduling complication to this option. Option SS-9 would impact local traffic; Route 6 eastbound and westbound in the vicinity of the utility corridor would require multiple traffic shifts for the Route 6 bridges and the on- and off-ramps.

*Multi-Modal Connections Rating: Most Favorable*

It is anticipated that connections to the local road network would be provided by shared use path direct connections to Cranberry Highway, Sandwich Road, and the Canal Service Road, including bicycle and pedestrian accommodations along Cranberry Highway and Cranberry Highway Extension.

*Utility Impacts Rating: Less Favorable*

In addition to the relocation of multiple utility poles, light poles, and overhead wire, Option SS-9 would interrupt the natural drainage patterns of the existing utility corridor. This option could require a drainage pump station or an outfall on Joint Base Cape Cod (JBCC) property. Additionally, three of the high voltage utility towers would be impacted by the roundabouts.

*Environmental Impacts Rating: Most Impactful*

This option would result in impacts to both the Joint Base Cape Cod (JBCC) Upper Cape Water Supply Reserve to the west and Massachusetts Department of Conservation and Recreation (DCR) property to the east. Both properties are protected under Article 97 and the DCR property also is protected under Section 4(f). Additionally, property impacts could involve a take of State-listed endangered species.

*Right-of-Way Impacts Rating: Most Impactful*

Based on conceptual design, this option would result in right-of-way impacts in addition to those impacts previously identified for the mainline alignment fully offline inboard location. Option SS-9 would result in two residential full property acquisitions; 14 residential partial property impacts, including a vacant parcel; one commercial full property acquisition, consisting of a vacant parcel; and eight commercial partial property impacts. The right-of-way impacts would not directly affect EJ communities or populations.

**9.6.2.5 Option SS-9.1**

Option SS-9.1 provides a variation of Option SS-9 while maintaining the shift of the mainline merge and diverge points for several ramps easterly along Route 6. In Option SS-9.1, however, the new westbound on-ramp is near its existing location at the end of Cranberry Highway. This allows a slight simplification of the connecting movements in the vicinity of the overhead utility corridor. This option does not extend Cranberry Highway. Figure 9-22 shows a conceptual layout of Option SS-9.1.



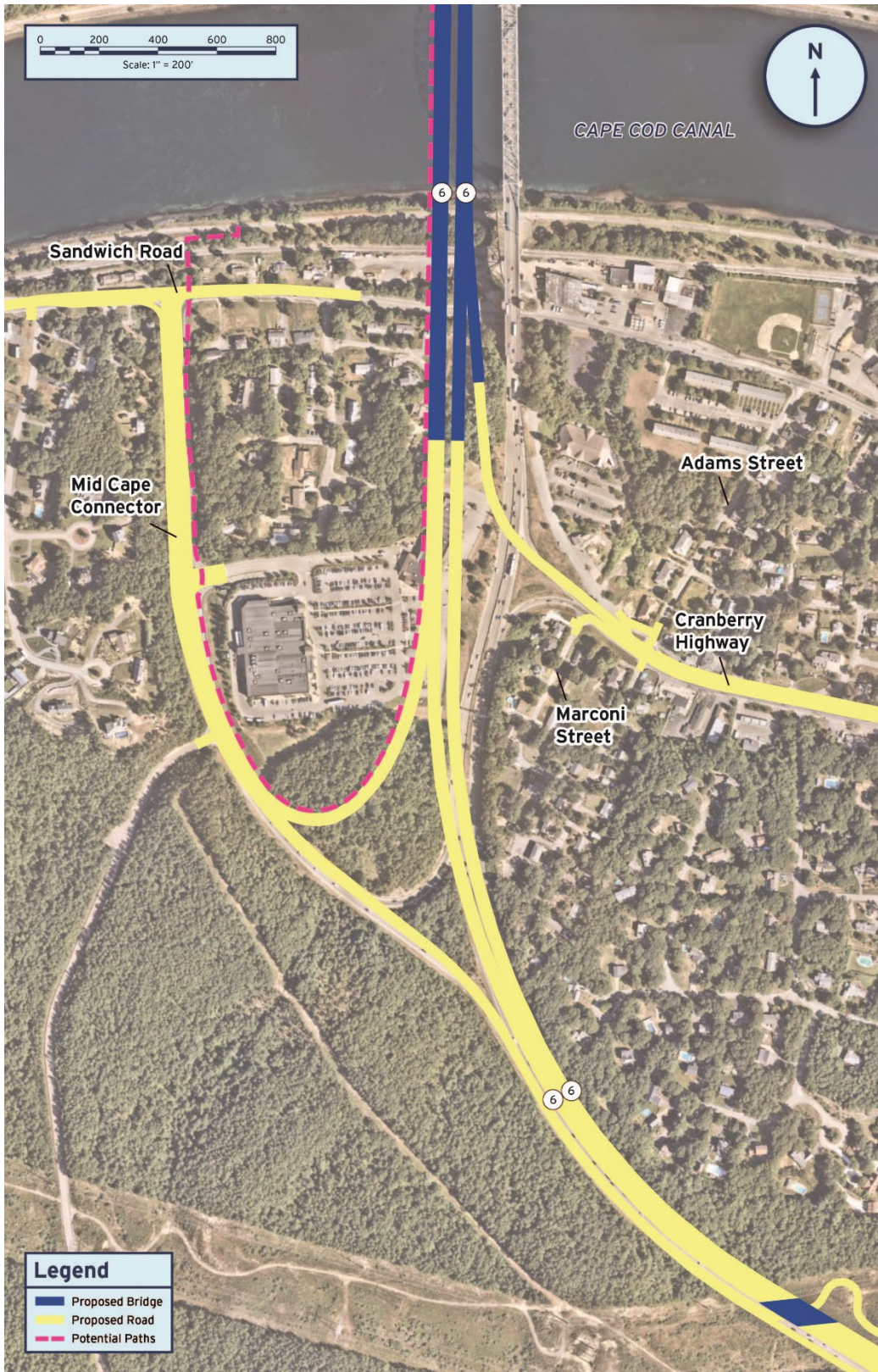


Figure 9-22. Sagamore South Crossing Interchange Approach Option SS-9.1

#### *Operations Rating: Favorable*

Operations modeling indicates that Option SS-9.1 would improve operations at the ramp junctions on Route 6. Additionally, this option would provide acceptable operations with the addition of a third approach lane on the Mid-Cape Connector at Sandwich Road. Further development of this option would require an evaluation of the Route 6 eastbound and westbound off-ramp traffic weave on the Mid-Cape Connector prior to the Market Basket intersection.

#### *Connectivity Rating: Less Favorable*

This option generally would maintain existing connections. However, in Option SS-9.1, traffic exiting Route 6 westbound onto the Mid-Cape Connector on the west rather than on the east would have reduced connectivity to properties along Cranberry Highway. In this option, the trip length from Route 6 westbound to Sandwich Road, west of the Mid-Cape Connector, would be reduced by a mile; and the trip length from Route 6 westbound to Route 6A, east of Cranberry Highway, would be increased by one-half-mile.

#### *Geometrics Rating: Unfavorable*

While the eastbound off-ramp would be designed at the desired 6 percent profile grade, the westbound on-ramp profile grade would be less than 6 percent. Additionally, the westbound off-ramp would introduce a sharp reverse curve geometry at the end of a downgrade prior to going under Route 6; this design would not meet horizontal design standards. Construction of the new Route 6 westbound off-ramp would involve a substantial excavation of up to 35 feet adjacent to the proposed hook turn (partial roundabout) within the utility corridor, east of Route 6. Further, the right turn movement for delivery vehicles exiting the Christmas Tree Shop driveway to Cranberry Highway would mimic existing conditions and encroach into the opposite lane of travel on Cranberry Highway.

#### *Safety Rating: Less Favorable*

Engineering assessments and safety modeling indicate that due to the geometric and cross-section improvements and ramp geometry, there would be a slight reduction in both the predicted number of crashes and the predicted crash rates on Route 6 and ramp segments. However, the long straight frontage road could encourage faster speeds heading north where the Route 6 eastbound off-ramp meets the Mid-Cape Connector. This option would result a negligible change in predicted crash rates on ramp roadways and negligible differences on Sandwich Road and the Mid-Cape Connector.

#### *Constructability Rating: Less Favorable*

The construction of ramps and connector roads would consist of a combination of new alignments adjacent to existing roadways. The new Route 6 westbound off-ramp and Route 6 eastbound on-ramp at the utility corridor would require temporary roadways in each direction while the barrels of the replacement bridges are built. Option SS-9.1 would not include the Cranberry Highway Extension, therefore a temporary Route 6 eastbound off-ramp would not be possible; however, this option would require some type of connection. This option would substantially increase the construction duration compared to other options: construction of the Route 6 westbound on-ramp from Cranberry Highway could not be completed until barrels of the replacement bridge are completed, and the existing Sagamore Bridge could not be demolished until the new Route 6 westbound on-ramp is completed. The required construction sequence could add a scheduling complication to this option. Route 6 eastbound and

westbound in the vicinity of the utility corridor would require multiple traffic shifts for the Route 6 Bridges and on- and off- ramps.

*Multi-Modal Connections Rating: Favorable*

It is anticipated that connections to the local road network would be provided by shared use path direct connections to Sandwich Road and the Canal Service Road, including bicycle and pedestrian accommodations along Cranberry Highway.

*Utility Impacts Rating: Less Favorable*

In addition to the relocation of multiple utility poles, light poles, and overhead wire, Option SS-9.1 would interrupt the natural drainage patterns of the existing utility corridor. This option could require a drainage pump station or an outfall on JBCC property. Additionally, three of the high voltage utility towers would be impacted by the roundabouts.

*Environmental Impacts Rating: Most Impactful*

This option would result in impacts to the DCR property to the east and, at a minimum, a permanent easement on the JBCC property. Both properties are protected under Article 97 and the DCR property also is protected under Section 4(f). Additionally, property takings could involve a take of State-listed endangered species.

*Right-of-Way Impacts Rating: More Impactful*

Based on conceptual design, this option would result in right-of-way takings in addition to those previously identified for the mainline alignment fully offline inboard location. Option SS-9.1 would result in two residential full property acquisitions; ten residential partial property impacts, including a vacant parcel; one commercial full property acquisition, consisting of a vacant parcel; and nine commercial partial property impacts. The takings would not adversely impact EJ communities or populations.

**9.6.2.6 Option SS-9.1A**

Option SS-9.1A is very similar to Option SS-9.1. The key difference between the two options is the Route 6 westbound off-ramp alignment. In Option SS-9.1A, the westbound off-ramp alignment crosses under the relocated Route 6 mainlines at a more gradual taper and requires a longer bridge. All other ramp configurations match those proposed in Option SS-9.1. Figure 9-23 shows a conceptual layout of Option SS-9.1A.



Figure 9-23. Sagamore South Crossing Interchange Approach Option SS-9.1A

#### *Operations Rating: Favorable*

Operations modeling indicates that Option SS-9.1A would improve operations at the ramp junctions on Route 6. Additionally, this option would provide acceptable operations with the addition of a third approach lane on the Mid-Cape Connector at Sandwich Road. Further development of this option would require an evaluation of the Route 6 eastbound and westbound off-ramp traffic weave on the Mid-Cape Connector prior to the Market Basket intersection.

#### *Connectivity and Geometrics Rating: Less Favorable*

This option generally would maintain existing connections. However, like Option SS-9.1, in Option SS-9.1A, traffic exiting Route 6 westbound onto the Mid-Cape Connector on the west rather than on the east would have reduced connectivity to properties along Cranberry Highway. In this option, the trip length from Route 6 westbound to Sandwich Road, west of the Mid-Cape Connector, would be reduced by a mile; and the trip length from Route 6 westbound to Route 6A, east of Cranberry Highway, would be increased by one-half-mile. While the eastbound off-ramp would be designed at the desired 6 percent profile grade, the westbound on-ramp profile grade would be less than 6 percent. Construction of the new Route 6 westbound off-ramp would involve a substantial excavation of 45 feet or more adjacent to the proposed reverse curve alignment passing under the mainline within the utility corridor, east of Route 6. Further, the right turn movement for delivery vehicles exiting the Christmas Tree Shop driveway to Cranberry Highway would mimic existing conditions and encroach into the opposite lane of travel on Cranberry Highway. The Cranberry Highway Extension (Option SS-1) could be incorporated into Option SS-9.1A.

#### *Safety Rating: Less Favorable*

Engineering assessments and safety modeling indicate that due to the geometric and cross-section improvements and ramp geometry, there would be a slight reduction in both the predicted number of crashes and the predicted crash rates on Route 6 and ramp segments. However, the long straight frontage road could encourage faster speeds heading north where the Route 6 eastbound off-ramp meets the Mid-Cape Connector. This option would result a negligible change in predicted crash rates on ramp roadways and negligible differences on Sandwich Road and the Mid-Cape Connector.

#### *Constructability Rating: Less Favorable*

The construction of ramps and connector roads would consist of a combination of new alignments adjacent to existing roadways. The new Route 6 westbound off-ramp and Route 6 eastbound on-ramp at the utility corridor would require temporary roadways in each direction while the while the barrels of the replacement bridges are built. Option SS-9.1A would not include the Cranberry Highway Extension, therefore a temporary Route 6 eastbound off-ramp would not be possible; however, this option would require some type of connection. This option would substantially increase the construction duration compared to other options: construction of the Route 6 westbound on-ramp from Cranberry Highway could not be completed until both barrels of the replacement bridge are completed, and the existing Sagamore Bridge could not be demolished until the new Route 6 westbound on-ramp is completed. The required construction sequence could add a scheduling complication to this option. Route 6 eastbound and westbound in the vicinity of the utility corridor would require multiple traffic shifts for the Route 6 Bridges and on- and off-ramps.

*Multi-Modal Connections Rating: Favorable*

It is anticipated that connections to the local road network would be provided by shared use path direct connections to Sandwich Road and the Canal Service Road, including bicycle and pedestrian accommodations along Cranberry Highway.

*Utility Impacts Rating: Less Favorable*

In addition to the relocation of multiple utility poles, light poles, and overhead wire, Option SS-9.1A would interrupt the natural drainage patterns of the existing utility corridor. This option could require a drainage pump station or an outfall on JBCC property. Additionally, one high voltage utility tower would be impacted by the Route 6 westbound off-ramp (retaining wall).

*Environmental Impacts Rating: Most Impactful*

Option SS-9.1A would not include the Cranberry Highway Extension, which would provide more direct vehicular, pedestrian and bicycle access to Market Basket. This option could result in impacts to the DCR property to the east, a minimum permanent easement on JBCC property for the retaining wall and drain outlet, and a permanent easement on State property for the retaining wall. The properties are protected under Article 97 and the DCR property also is protected under Section 4(f). Additionally, the DCR property impacts could involve a take of State-listed endangered species.

*Right-of-Way Impacts Rating: More Impactful*

Based on conceptual design, this option would result in right-of-way impacts in addition to those impacts previously identified for the mainline alignment fully offline inboard location. Option SS-9.1A would result in two residential full property acquisitions; ten residential partial property impacts, including a vacant parcel; one commercial full property acquisition, consisting of a vacant parcel; and nine commercial partial property impacts. The takings would not adversely impact EJ communities or populations.

## 9.7 Summary of Phase 1 Interchange Approach Assessments

Sections 9.3 through 9.6 present the Phase 1 screening results of initial interchange approach options for the Bourne and Sagamore crossings. Table 9-5 identifies the interchange approach alternatives for the Bourne and Sagamore crossings to be advanced for Phase 2 screening. Cumulative impacts, including utility, environmental, and right-of-way impacts would result when the Fully Offline Inboard mainline alignment for each crossing is paired with the interchange approach alternatives.

Table 9-5. Bourne and Sagamore Crossing Interchange Approach Alternatives for Further Screening

Program Study Area	Alternative	Summary Description
Bourne North	BN-6.1	Like the existing interchange configuration, modified to meet the offset mainline while adding a new northbound on-ramp directly from Scenic Highway east of the mainline.
	BN-13.1	Builds upon Alternative BN-6.1 and adds a connection from Route 25 southbound off-ramp directly to Scenic Highway.
	BN-14.4b	Like Alternative BN-13.1 and provides a combination of direct connection ramps between Route 25 and Route 6.

Program Study Area	Alternative	Summary Description
Bourne South	BS-2	Replaces the existing Bourne Rotary with a grade separated diamond interchange.
	BS-2.2	Replaces the existing Bourne Rotary with a grade separated single point interchange configuration.
Sagamore North	SN-1A	Like the existing interchange ramp configurations with modifications to support the relocated Route 3 alignment.
	SN-8A	Like Alternative SN-1A but provides a single exit point from a relocated Route 3.
Sagamore South	SS-1	Modifies ramp alignments to accommodate the relocated Route 6 mainline while largely maintaining the existing ramp configurations. Extends Cranberry Highway under Route 6 to provide a connection to Mid-Cape Connector.
	SS-1.1	Provides the same interchange configuration as Alternative SS-1 but eliminates the Cranberry Highway Extension.
	SS-3.1A	Like Alternative SS-1 but relocates the northbound on-ramp so it shares the same entrance point as the southbound on-ramp off the Mid-Cape Connector.

## 10 Conclusions and Next Steps

MassDOT’s Phase 1 and Phase 2 assessments presented in this Alternatives Analysis Report incorporate and build upon the USACE’s MRER/EA and Finding of No Significant Impact (FONSI) for Replacement of Both Highway Bridges with New Bridges with Four Through-Traffic Lanes and Two Auxiliary Lanes (In-Kind Bridge Replacement, updated to comply with federal and state highway and design safety standards).

In coordination with USACE and FHWA, MassDOT conducted extensive analysis of multiple design parameters for the development of the Cape Cod Bridges Program. In the Phase 1 and Phase 2 assessments, MassDOT evaluated, confirmed, and expanded upon the design parameters identified in the MRER/EA’s Preferred Alternative. Table 10-1 summarizes the design parameters for the Cape Cod Bridges Program based on the USACE’s foundational document and MassDOT’s subsequent Phase 1 and Phase 2 assessments.

Table 10-1. Summary of Cape Cod Bridges Program Design Parameters

Alternatives Analysis/Options Assessment	Design Decision
USACE MRER/EA and FONSI	Replacement of Both Highway Bridges with New Bridges with Four Through-Traffic Lanes and Two Auxiliary Lanes (In-Kind Bridge Replacement, updated to comply with federal and state highway and design safety standards).

Alternatives Analysis/Options Assessment	Design Decision
<p><b>Phase 1 Bridge Highway Assessments: Highway Cross-Section and Shared Use Path</b></p>	<p>Two 12-foot-wide through travel lanes, a 12-foot-wide entrance/exit (auxiliary) lane, a 4-foot-wide left shoulder, and a 10-foot-wide right shoulder. Right and left barriers would be offset an additional 2 feet beyond the limits of the shoulders. Each bridge crossing would include one bi-directional pedestrian and bicycle SUP, separated from vehicular traffic by the shoulder and barrier; width of SUP to be determined as design advances.</p>
<p><b>Phase 1 Bridge Assessment: Vertical and Horizontal Clearances</b></p>	<p>Increased vertical clearance of the existing bridges by 3.18 feet; both replacement bridges would be designed for a vertical clearance of approximately 138 feet above MHW. Both replacement bridges would provide a minimum of 500 feet of horizontal channel width to be consistent with existing conditions.</p>
<p><b>Phases 1 &amp; 2 Bridge Assessments: Main Span Length and Bridge Pier Location</b></p>	<p>The replacement bridges would have a main span length of approximately 700 feet, which would locate the bridge piers at the waterline adjacent to the service road (shoreline piers), into the rip rap slope but above the low tide line.</p>
<p><b>Phases 1 &amp; 2 Bridge Assessments: Bridge Deck Configuration</b></p>	<p>The replacement bridge structure configuration would be twin parallel decks at each crossing.</p>
<p><b>Phases 1 &amp; 2 Bridge Assessments and Community Review: Bridge Types</b></p>	<p>The replacement bridges would be twin Tied-Arch Bridges with Delta Frame supporting an approximate 700-foot mainline span.</p>
<p><b>Mainline Alignment Location Assessment</b></p>	<p>The mainline alignment locations would be Fully Offline Inboard at both crossings. At the Bourne location, both barrels of the replacement highway bridge would be located east of and outside the footprint of the existing Bourne Bridge, closer to Cape Cod Bay. At the Sagamore location, both barrels of the replacement highway bridge would be located west of and partially within the footprint of the existing Sagamore Bridge, toward Buzzards Bay.</p>
<p><b>Phase 1 Highway Interchange Approach Assessments</b></p>	<p>Ten interchange approach alternatives will be advanced for Phase 2 screening: three for Bourne North; two for Bourne South; two for Sagamore North, and three for Sagamore South.</p>



Incorporating the USACE's Preferred Alternative of In-Kind Bridge Replacement, updated to comply with federal and state design and safety standards, and the design decisions of the Phase 1 and Phase 2 assessments, MassDOT will conduct further design, including identifying avoidance, minimization and mitigation measures as needed.

As design advances, MassDOT will conduct the Phase 2 highway interchange approach alternatives analysis to determine the preferred interchange approach Build alternative (a single set of interchange pairings) for each crossing. Concurrently, MassDOT will determine the location and width of the shared use path, including connections with the local roadway network. The results of the Phase 2 analysis and identification of the Preferred Alternative for the highway interchange approaches at the bridge crossings will be reported in the Draft Environmental Impact Report (DEIR) and the NEPA document.

# Appendix A Cape Cod Bridge Replacements Initial Screening Report



CAPE COD BRIDGE REPLACEMENTS

# Initial Screening Report

PREPARED BY

**HNTB**

FOR

**massDOT**  
Massachusetts Department of Transportation

2021

Cape Cod Bridges - Initial Screening Report

TABLE OF CONTENTS

1 Introduction .....1

2 Bridge Design Parameters.....2

2.1 Navigational Clearances.....2

2.2 Roadway Width.....2

2.3 Main Span Length .....2

2.4 Deck Arrangement .....2

2.5 Main Span Bridge Type .....4

2.6 Cable-Stayed Bridge Tower Configuration.....5

2.7 Tied Arch Bridge Rib Configurations .....6

2.8 Main Span Girder Type .....6

2.9 Approach Bridge Type.....7

3 Screening Criteria.....7

3.1 Introduction .....7

3.2 Initial Cost .....7

3.3 Highway Geometrics .....7

3.4 Main Span Footings.....8

3.5 Construction.....8

3.6 Structural Redundancy.....10

3.7 Inspection & Maintenance.....10

3.8 Durability.....10

3.9 Wind Response .....11

3.10 Snow and Ice response .....11

3.11 Community.....11

4 Screening Matrices.....12

4.1 Introduction .....12

4.2 Main Span Length .....12

4.3 Deck Configuration .....12

4.4 Single Bridge.....12

4.5 Separate Bridges .....12

4.6 Medium-Long-Span Bridge Types.....13

4.7 Long-Span Bridge Types.....13

4.8 Cable-Stayed Bridge Towers .....13

4.9 Cable-Stayed Bridge Pylons.....13

4.10 Arch Rib Configurations .....13

4.11 Haunched Box Girder Bridges .....13

4.12 Deck Girder Types .....13

4.13 Approach Bridge Types .....13

5 Proposed Configurations .....13

Appendix A – Screening Matrices

Appendix B – Massing Studies of Proposed Bridge Types and Configurations

1 INTRODUCTION

The existing Cape Cod Bridges, comprising Sagamore Bridge to the east and Bourne Bridge to the west, cross the Cape Cod Canal to link Cape Cod with the mainland (Fig. 1.1). The bridges were opened in 1935 and have reached the end of their useful economic life. In a Major Rehabilitation Evaluation Report (MRER) completed in March, 2020, the US Army Corps of Engineers recommended construction of new bridges located parallel to and immediately inshore of the existing bridges. The MRER envisions that the new bridges accommodate two through-travel lanes, one auxiliary on/off lane, a 10-ft inside shoulder and a 4-ft outside shoulder for each direction. In addition, a shared-use path for dedicated pedestrian and bicycle traffic would be provided.

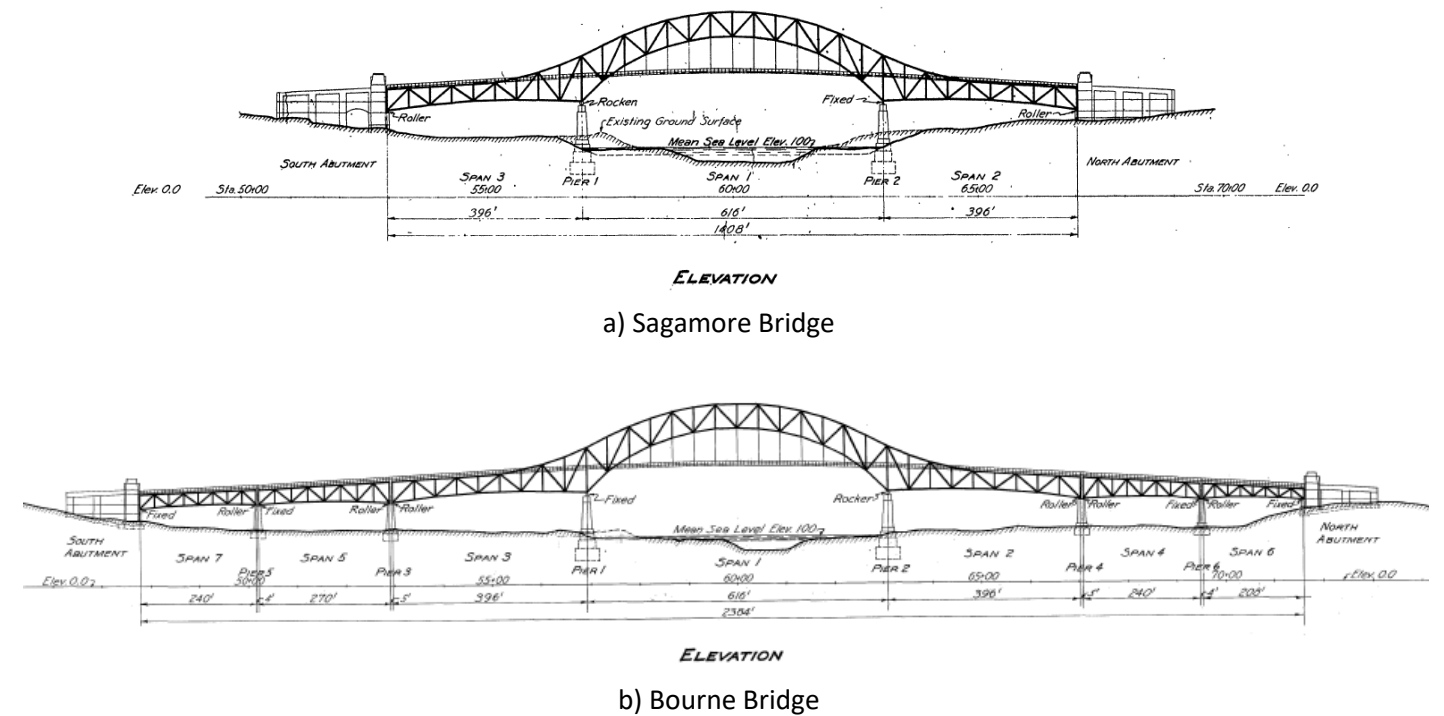


Fig. 1.1 – Existing Cape Cod Bridges

This report summarizes the results of an initial screening study performed to identify feasible bridge types and configurations for further evaluation. This is the first of three phases which will ultimately lead to a Type, Size, and Location Study and support the development of MassDOT’s Bridge Type Selection Worksheet. For the purposes of this initial screening, no distinction was made between the Sagamore and Bourne bridges; the analysis presented here at this level of conceptual design applies to both.

For the initial assessment a wide range of bridge types and design parameters were considered and screened by a set of criteria. For the sake of clarity each parameter was initially evaluated separately. This pre-screening allowed the team to quickly identify the decision drivers for bridge type selection, to advance favorable design features, and to eliminate unfavorable alternatives. The process was collaborative, taking place through a series of virtual meetings attended by MassDOT, the US Army Corps of Engineers, FHWA, and HNTB. The final product of this phase is a matrix of potential bridge types and configurations to be further evaluated in the next phase of conceptual design in conjunction with highway design considerations. Possible foundation types for main span and approaches will be screened separately based on the results of geotechnical explorations that are currently ongoing. Important bridge design parameters and evaluation criteria are depicted in Figure 1.2 and are discussed in the following

Sections 2 and 3. The completed evaluation matrices and the proposed bridge type matrix are presented in Sections 4 and 5 of this report and in two appendices.

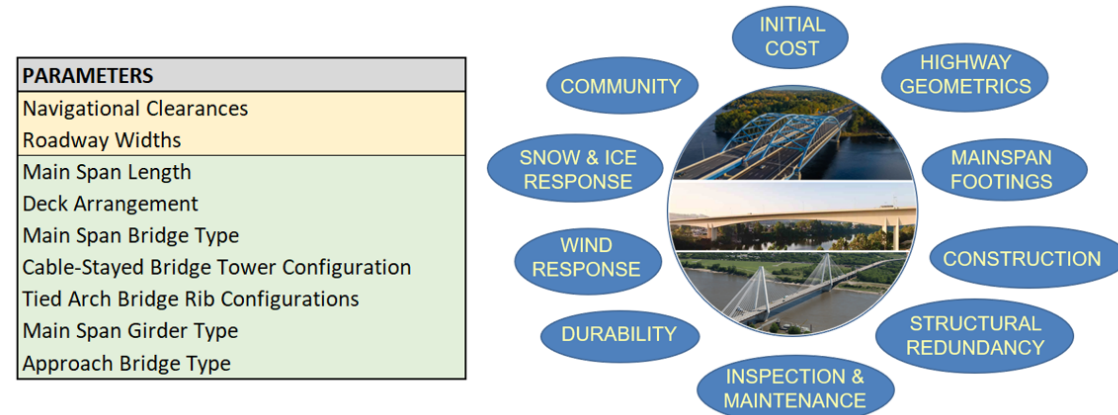


Fig. 1.2 – Bridge Design Parameters and Screening Criteria

## 2 BRIDGE DESIGN PARAMETERS

### 2.1 Navigational Clearances

The minimum navigational clearances are controlled by the width of the existing channel of 480 feet and the requirement to maintain a vertical clearance above mean high water of 135 feet. The MRER follows the US Army Corps of Engineers’ protocol in considering rates of sea level rise that are higher than historical rates to account for the potential impacts of climate change. It took a conservative approach recommending the “high sea level rise” estimate as a starting point for conceptual design. This resulted in an increase to the clearance requirement above mean high water by 7.8 feet to approximately 143 feet as indicated by the minimum clearance box shown in Figure 2.1. As conceptual design of the bridges and approaches progresses, there will be further evaluation of the most appropriate scenario of sea level rise to include in the final design elevation.

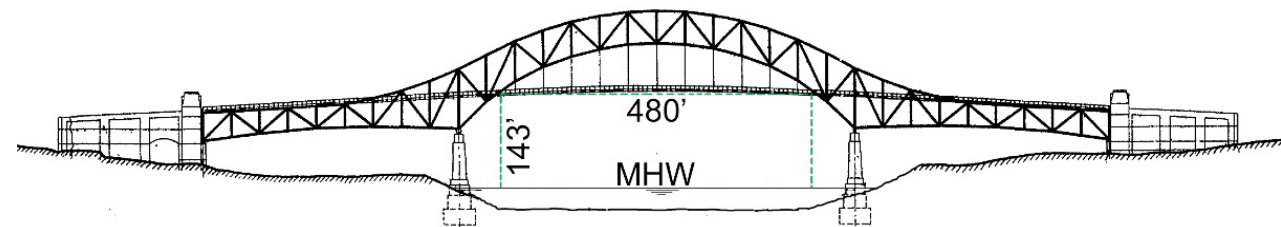


Fig. 2.1 – Navigational Clearance Requirements

### 2.2 Roadway Width

With the preliminary lane and shoulder configuration described in Section 1 the minimum roadway width is 54 feet per direction (Fig. 2.2). This includes two 12-foot through lanes, a 12-foot auxiliary on/off lane, and 10-foot and 4-ft shoulders each with two-foot offsets from the adjacent barriers. The shared use path width is 14 feet, accounting for a 10-foot path and two two-foot offsets to each barrier.

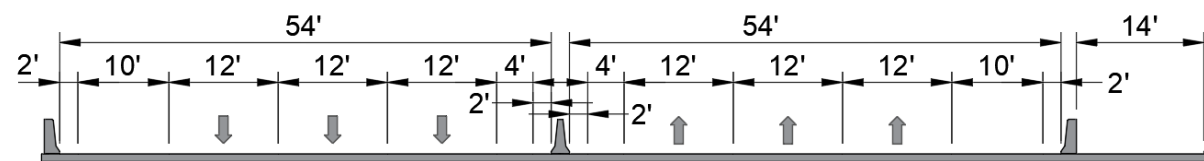


Fig. 2.2 – Roadway Widths

### 2.3 Main Span Length

The main span length is a critical parameter that affects bridge type selection and bridge cost. This relationship is shown schematically in Figure 2.3. The vertical dashed lines indicate the range of possible spans appropriate for this crossing. This chart suggests that for the applicable span range (525 to 820 feet) the most efficient structure types include haunched box girder, arch bridge, and cable-stayed bridge. A range for truss bridges is not shown but it is similar to that for arch bridges.

Another observation from the chart is that unit cost per deck area increases with span length. This is a consequence of the fact that the demand on the structure indicated by the maximum bending moment increases with the square of the span length, while resistance in the form of structure depth increases only linearly. This relationship is tempered if there is a clear advantage for foundation construction with a longer span. In general, for structural efficiency, span length should be limited to the minimum needed to meet functional and aesthetic requirements.

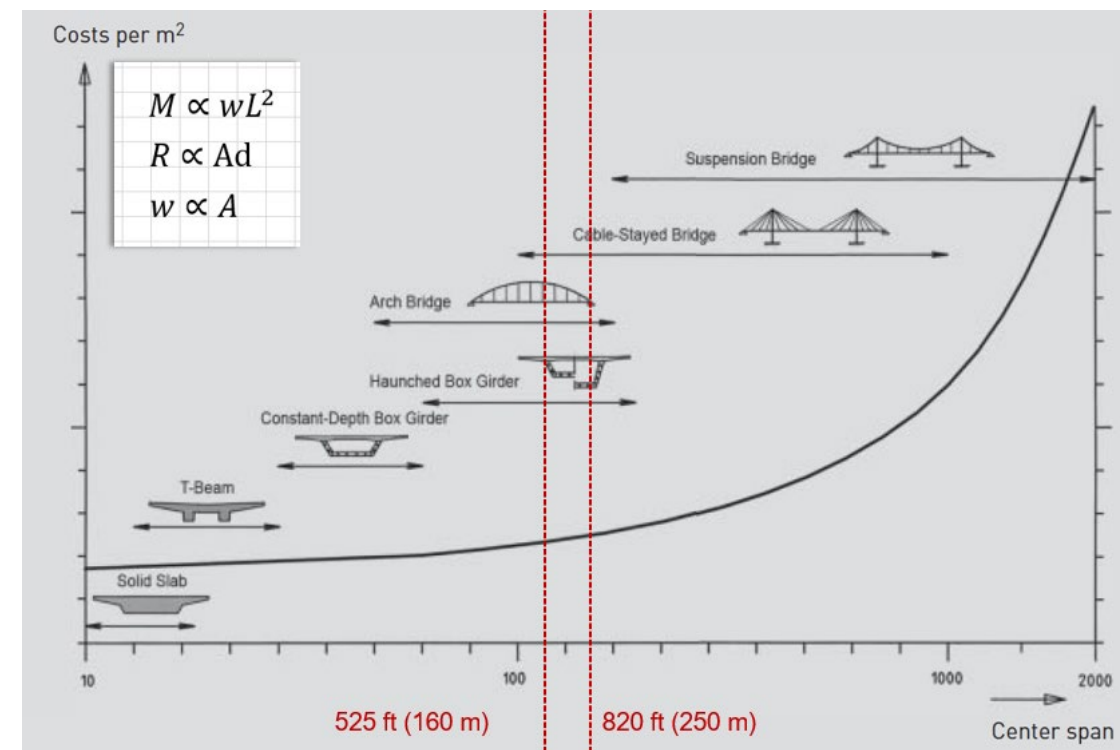
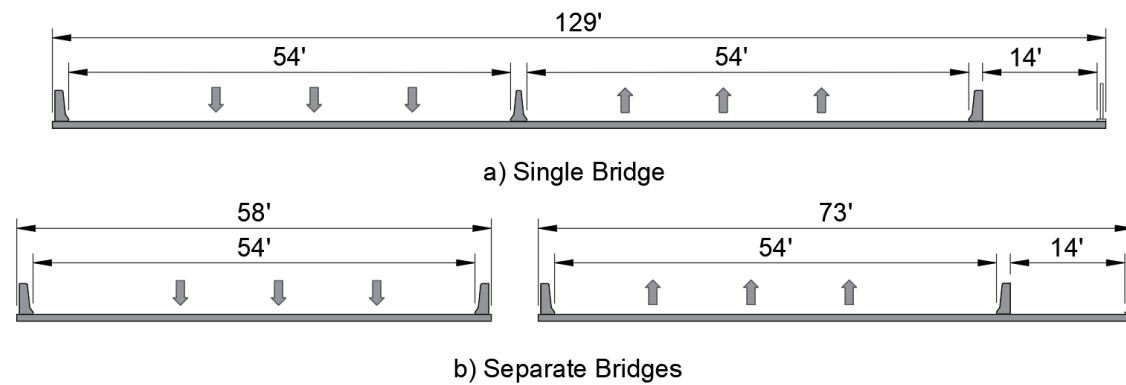


Fig. 2.3 – Bridge Type and Cost vs. Span Length  
(Adapted from Svensson, H., *Cable-Stayed Bridges – 40 Years of Experience Worldwide*, Ernst & Sohn, 2011)

### 2.4 Deck Arrangement

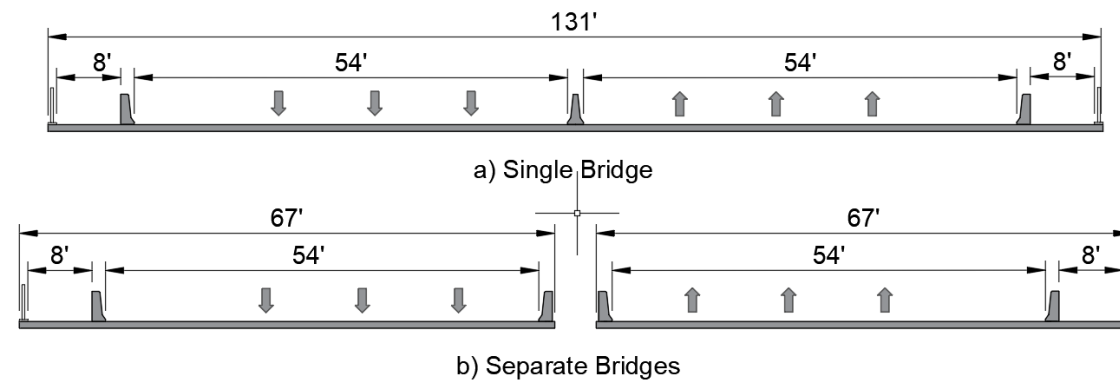
#### 2.4.1 Number of Bridges

To accommodate two 54-ft wide roadways in each direction, a 14-ft shared use path, and traffic barriers the required width of a single deck is approximately 129 feet (Fig. 2.4a). This results in very long floorbeam spans which increases cost and complexity of construction. Therefore, a configuration using two separate bridges can be cost-effective (Fig. 2.4b). This option also has the advantage that it allows phased construction, where one of the bridges is erected first and then carries all traffic in a temporary configuration while the old bridge is demolished and replaced by the second-phase new bridge. The phased construction scheme is discussed in more detail in Section 3.5.1.



**Fig. 2.4 - Deck Configurations with Single Shared-Use Path**

A potential concern with a single shared-use path is the safety of pedestrians and bicyclists with critical traffic densities. The situation is exacerbated by the steep grades of the approach bridges which will amplify the speed difference between descending bicyclists and pedestrians. For this reason deck configurations with separate paths for cyclists and pedestrians were added to the evaluation matrix (Fig. 2.5). Besides the improvements for non-vehicular use, the resulting symmetric geometry also has advantages for construction since it simplifies details and maximizes repetition. The goal at this conceptual stage is only to evaluate the effect of the various shared-use path arrangements on bridge types.



**Fig. 2.5 - Deck Configurations with Separate Non-Vehicular Paths**

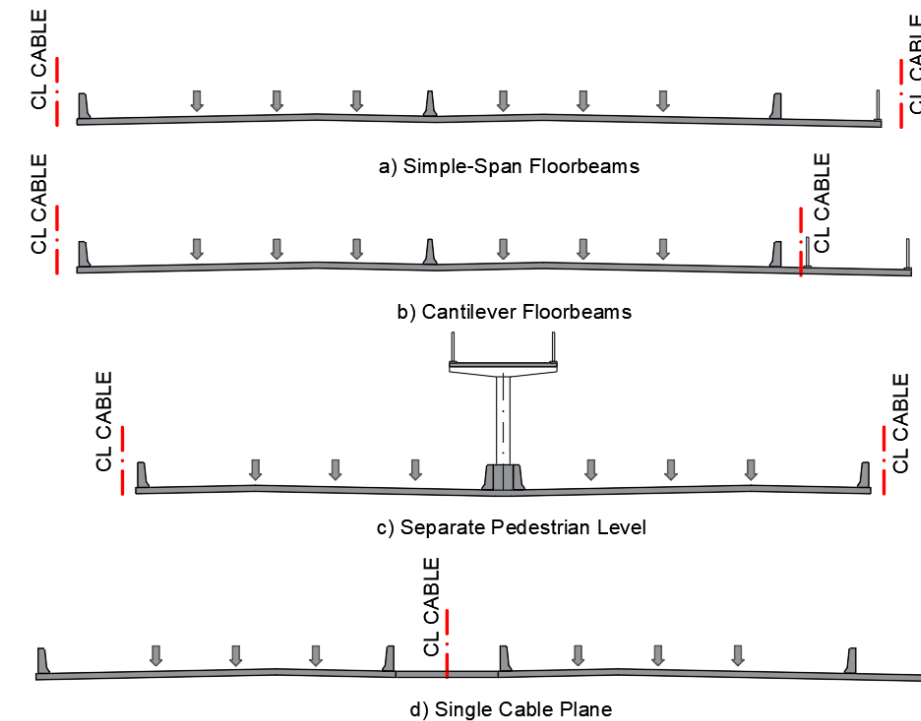
**2.4.2 Single Bridge**

Among the single bridge deck alternatives a distinction can be made with regard to where the supporting elements – cables or truss members - are located relative to the deck width. In Figure 2.6a the floorbeams span over the full width. Figure 2.6b shows a configuration where one of the cable planes is located between roadway and shared-use path. This arrangement achieves structural efficiencies because it reduces floorbeam span length and it also creates a visual and physical barrier that would enhance the user experience for pedestrians and bicyclists.

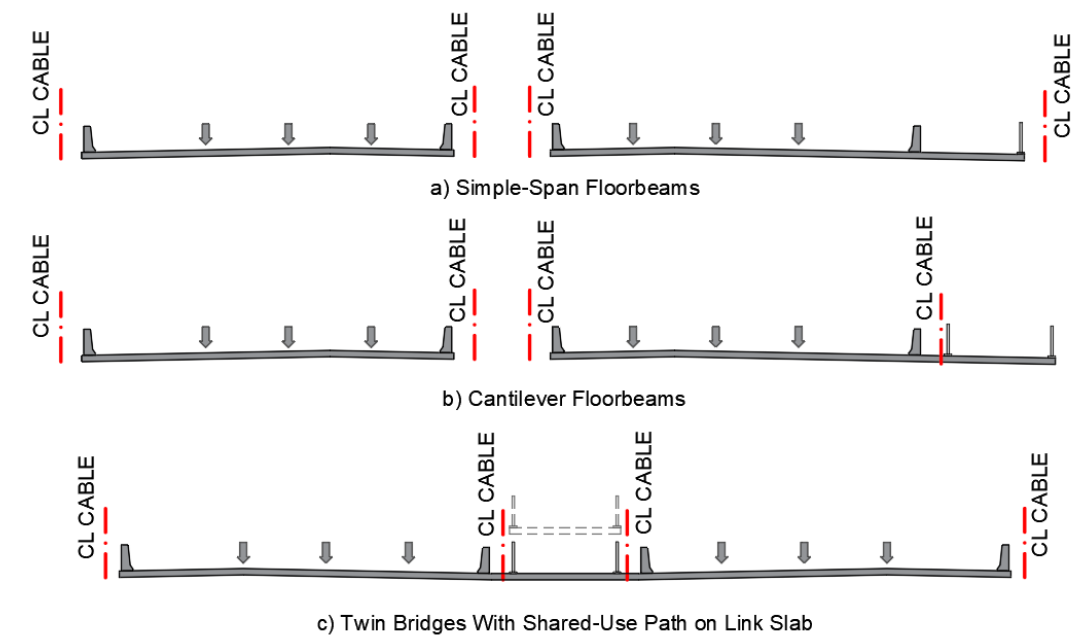
In Figure 2.6c separation between non-vehicular and vehicular traffic is taken a step further by moving the shared-use path to its own level. This arrangement can accommodate different gradients for roadway and path by varying the height of the support columns. A disadvantage is the unfavorable loading for the floorbeams due to the introduction of a concentrated load in mid span. Figure 2.6d shows an arrangement with a single cable plane. This configuration results in the greatest deck width because the roadways must be sufficiently separated for a central tower to pass between them.

**2.4.3 Separate Bridges**

Figures 2.7a and b depict the analogous configurations to the single-deck options where one of the cable planes can be arranged either outside the shared-use path or between path and roadway. The arrangement shown in Figure 2.7c envisions two identical structures carrying the roadways with a link slab carrying the path which would be constructed at a later stage.



**Fig. 2.6 - Single Bridge Deck Configurations**



**Fig. 2.7 - Separate Bridge Deck Configurations**

### 2.5 Main Span Bridge Type

Figures 2.9 and 2.10 show preliminary elevation views of the various main span bridge options. For the Cape Cod Canal bridge sites, the potential span lengths vary from approximately 525 feet to 820 feet (see Section 3.1). The first figure is representative of spans in the range of 525 to 700 feet, the second figure has been developed assuming an 820-foot span.

For the tied arch options there are two configurations. The traditional system uses vertical piers with the arches supported on top of these piers (Figures 2.9a and 2.10a). Alternatively, with the Delta-frame arrangement the approach spans cantilever into the main span, thus shortening the length of the actual tied arch, albeit at the expense of a more complex approach span structure (Figures 2.9b and 2.10b). Visually this scheme echoes the appearance of the existing through-arch bridges. It also offers advantages for construction if the tied arch span is fabricated off-site, delivered by barge, and lifted into its final position.

Both arch configurations use inclined cables arranged in a network pattern. This simple change from the traditional arrangement with vertical cables creates significant advantages for structure behavior and structure redundancy. The rise of the arches ranges from 1/5<sup>th</sup> to 1/6<sup>th</sup> of the span length.

For the truss options (Figures 2.9c and 2.10c) a constant depth truss is envisioned for the medium-long span ranges with a span-to-depth ratio of approximately 12 to 15. For the 820-ft span Figure 2.10c shows a variable depth truss with tentative structure depths of 110 feet at the supports and 50 feet at midspan.

For the cable-stayed bridge alternatives, configurations with a single tower or two towers were developed (Figures 2.9d, e, 2.10d, e). The single-tower option results in the tallest structure with a tower height above deck between 30% and 40% of the span length (i.e. approximately 250 feet). If geological and other constraints permit, two-tower configurations tend to be more efficient, with tower heights in the range of 20% to 25% of the main span length.

For the 820-ft span a suspension bridge option is included as shown in Figure 2.10g, although this length falls short of the typical span range where such an alternative would normally be considered. Suspension bridges allow the use of a very slender and light deck at the expense of large gravity blocks at each end needed to anchor the main cables.

The haunched girder alternatives, either in the form of a steel box or a post-tensioned concrete box, do not require supporting structure above the deck level (Fig. 2.9f, g, 2.10f). However, at the controlling location at the edges of the navigational clearance box their girder depth is 10 to 20 feet greater than for the other alternatives. As illustrated in Figure 2.8 by using the example of arch and concrete box girder alternatives for a 700-ft main span, this greater depth has an unfavorable impact on length and grade of the approach bridges.

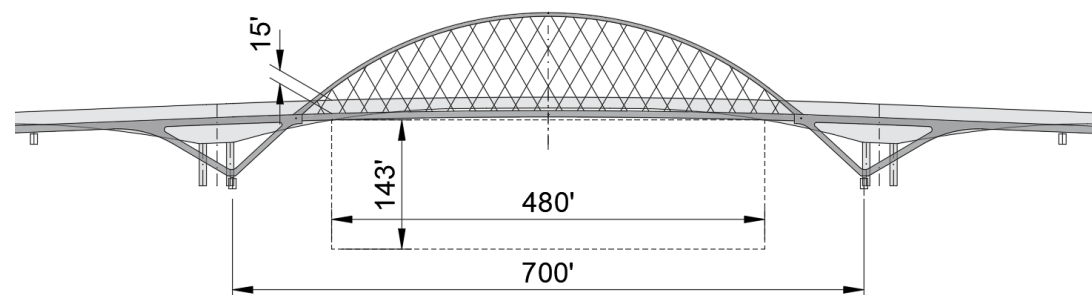


Fig. 2.8 – Influence of Girder Depth on Highway Profile

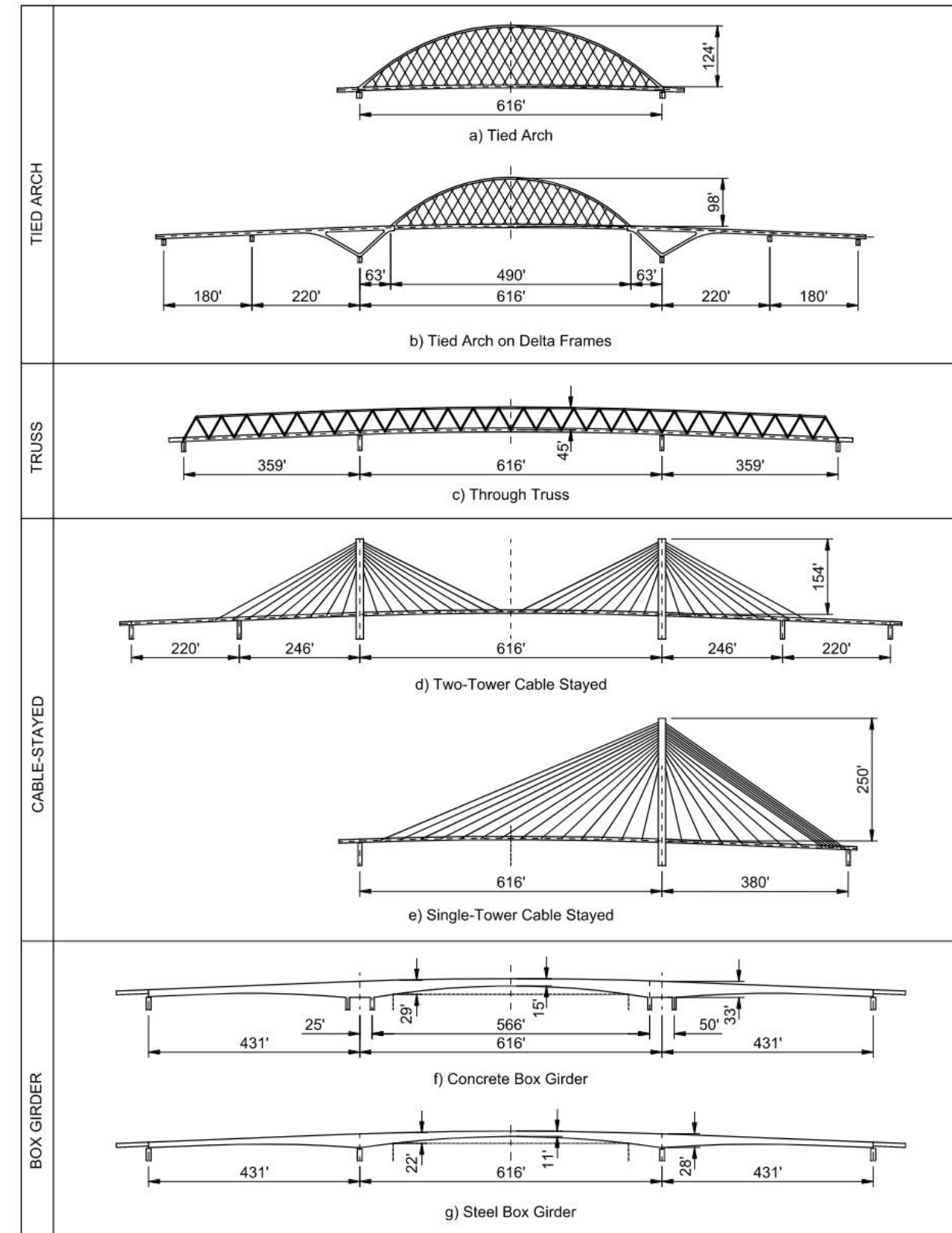


Fig. 2.9 – 525-ft to 700-ft Span Options (616-ft foot span shown, 525-ft & 700-ft Spans Similar)

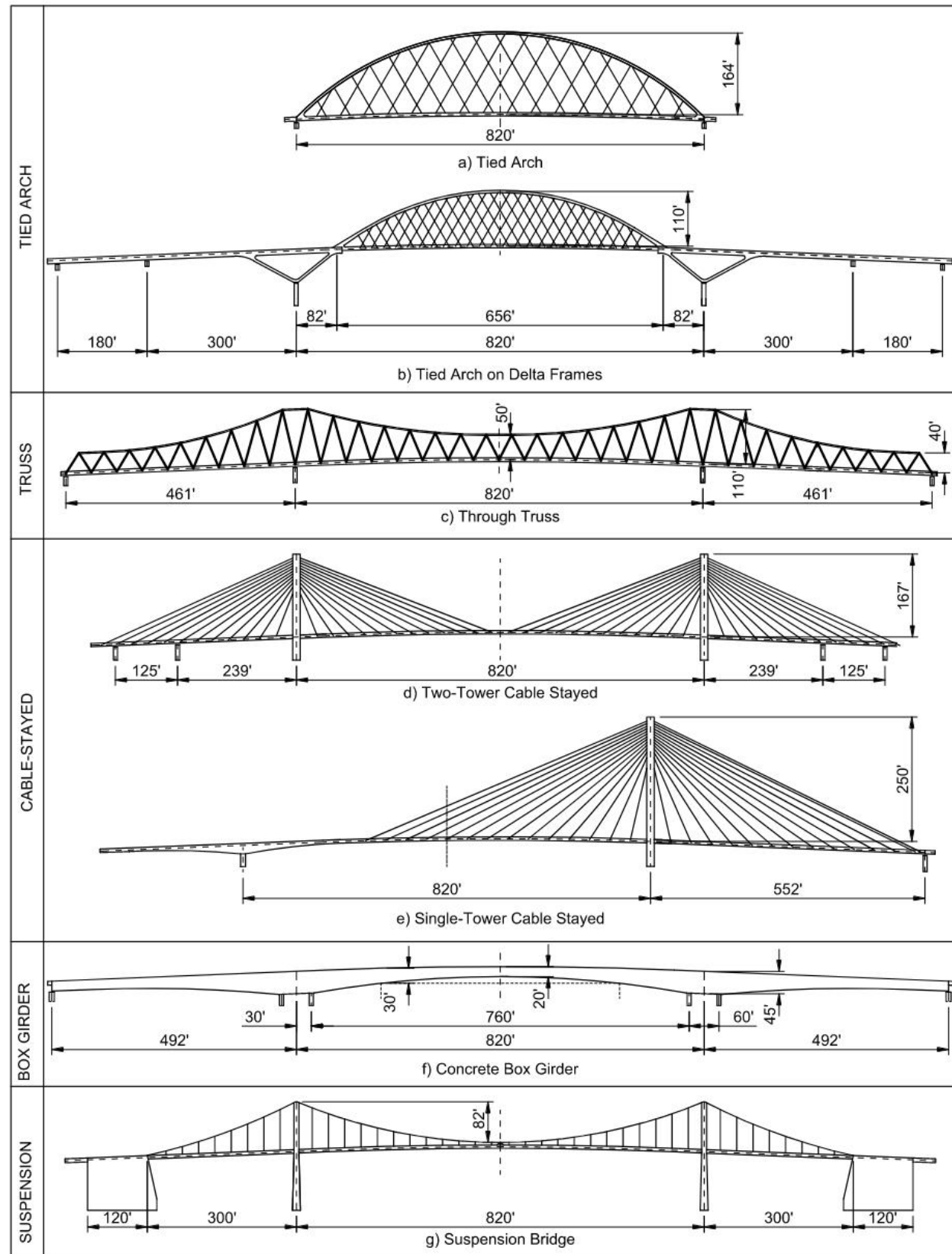


Fig. 2.10 – 820-ft Span Bridge Options

2.6 Cable-Stayed Bridge Tower Configuration

For the cable-stayed bridge alternatives, a number of tower configurations are feasible, identified as H, A, and inverted-Y tower and central pylon in Figure 2.11. Figure 2.12 shows representative examples in completed bridge structures. Under high wind-load conditions A-towers or H-towers with upper cross bracing are more efficient than single-leg towers or free-standing H (or V)-towers.

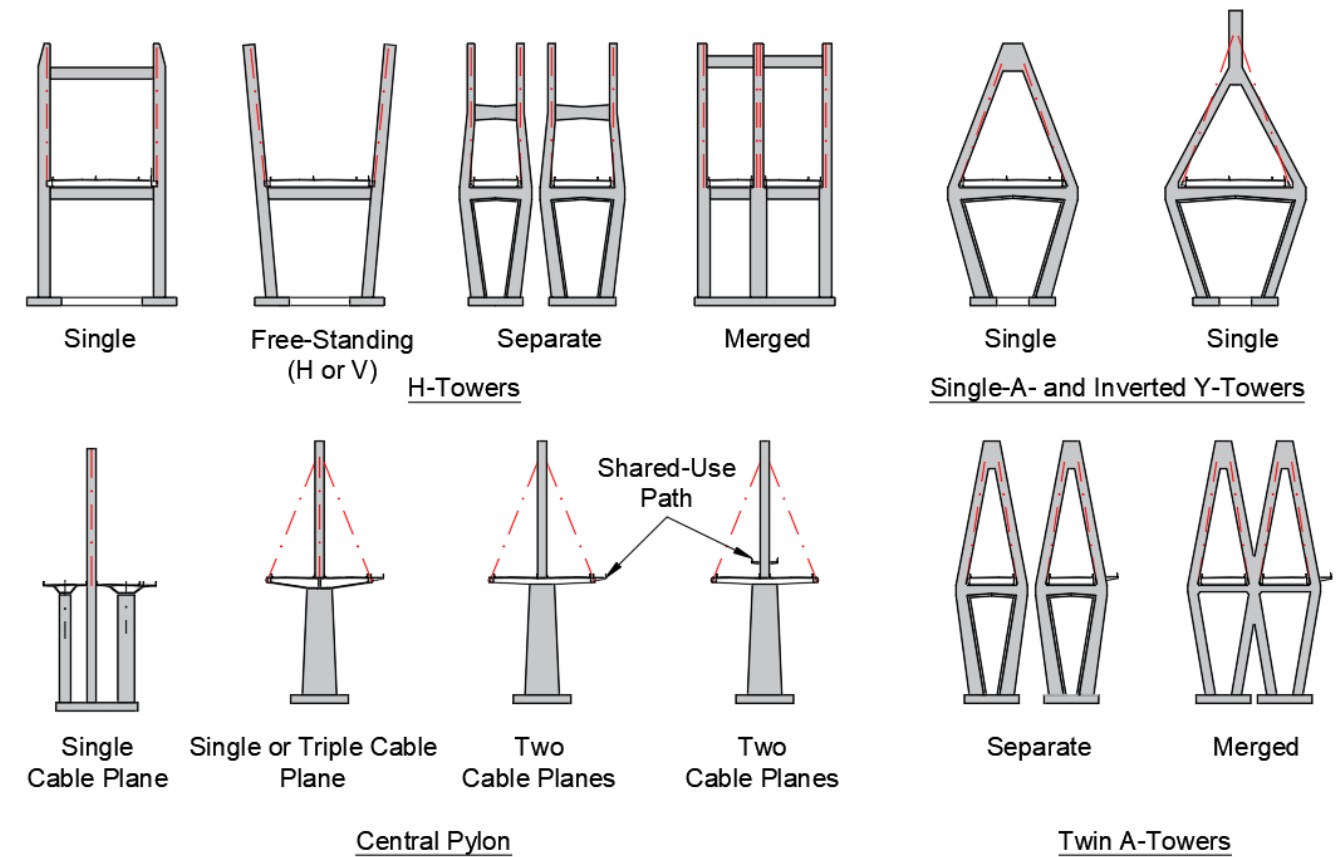


Fig. 2.11 – Cable-Stayed Bridge Tower Configurations

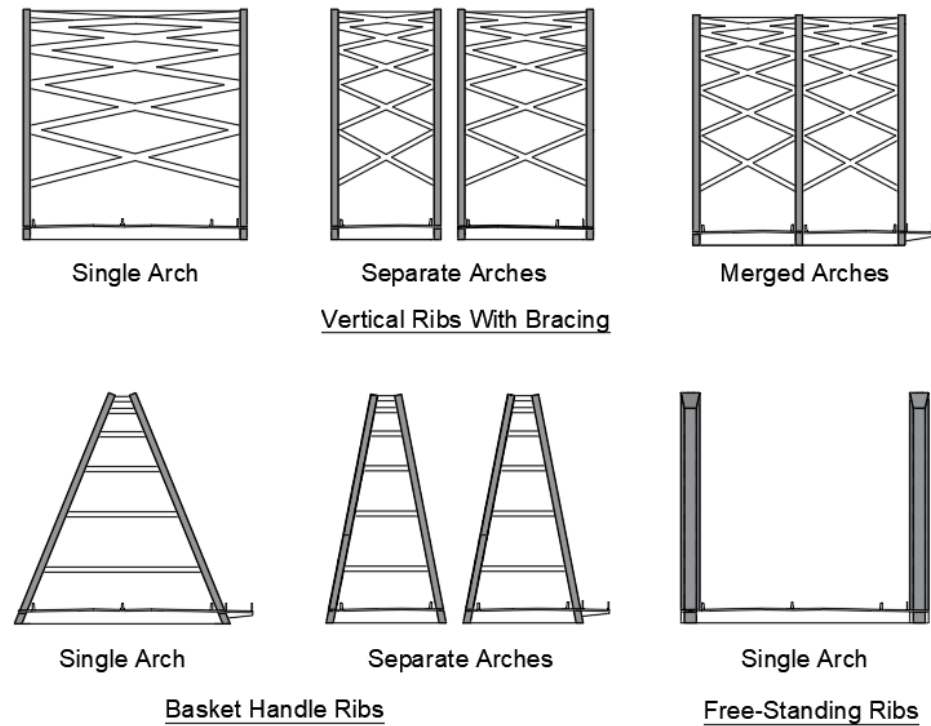


Fig. 2.12 – Representative Examples for Cable-Stayed Bridge Options



**2.7 Tied Arch Bridge Rib Configurations**

For the tied arch options Figure 2.13 shows configurations with braced vertical ribs, with inclined ribs to create a basket handle arrangement, and with free-standing vertical ribs. Figure 2.14 illustrates these structure types with photographs of representative examples.



**Fig. 2.13 – Tied Arch Rib Configurations**



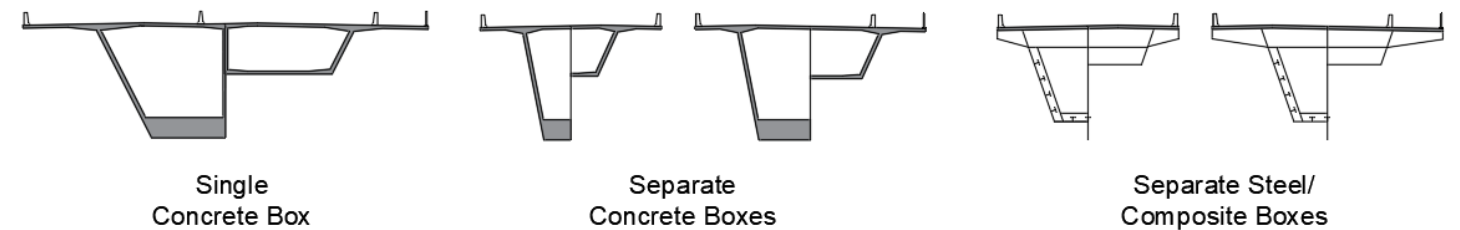
**Fig. 2.14 – Representative Examples for Network Tied Arch Options**

With the free-standing ribs the upper lateral bracing is eliminated. Arch rib stability is ensured by making these members significantly wider and by fixing them into the end floorbeams. Basket handle arches are visually attractive and reduce upper lateral bracing demands, but they are more difficult to construct than vertical arch ribs. Also, there is a potential conflict between traffic clearance requirements and the inclined ribs as they lean over the roadway. This concern becomes particularly acute with wide bridge decks and low arch rib rise and can make this option infeasible under those circumstances.

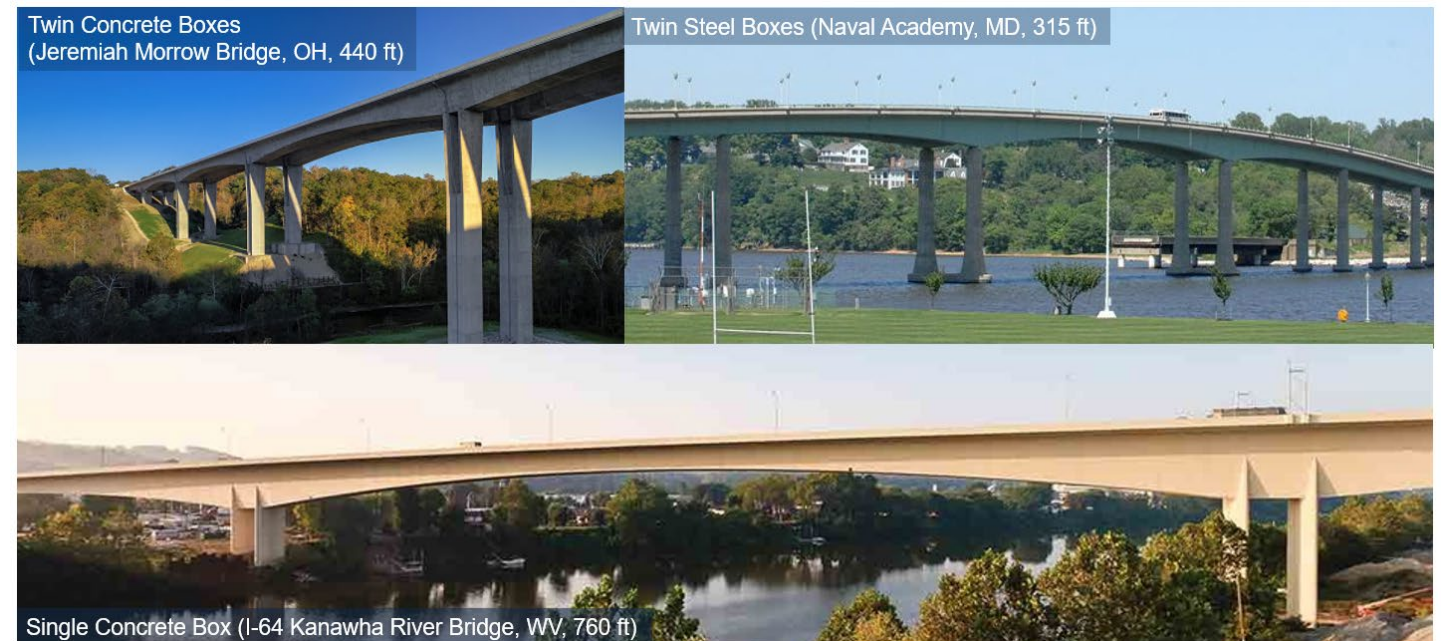
**2.8 Main Span Girder Type**

**2.8.1 Haunched Box Girder Bridges**

Haunched box girder bridges may be of either post-tensioned concrete, composite steel with concrete deck, or steel with orthotropic deck (Fig. 2.15, 2.16). There is no recent experience in the US with steel box girder bridges for this span range. The current span length record for a concrete box girder bridge is held by the I-64 Kanawha River crossing in Charleston, West Virginia with a main span length of 760 feet. However, span lengths in excess of 900 feet are feasible with this type of structure.



**Fig. 2.15 – Haunched Girder Cross Sections**



**Fig. 2.16 – Representative Examples for Haunched Box Girder Bridge Options**

2.8.2 Cable Supported Bridges – Deck Systems

A typical and efficient deck system for cable supported bridges, cable-stayed or arch, comprises longitudinal edge girders and closely spaced transverse floorbeams (Fig. 2.17a-d). With tied arches or trusses it is advantageous to configure the edge girder as a closed box (Fig. 2.17a). The box can be designed to tolerate partial loss of the cross section and thus provides internal member redundancy. In addition it allows for the cables to be anchored inside the box for better protection from the elements and for ease of inspection.

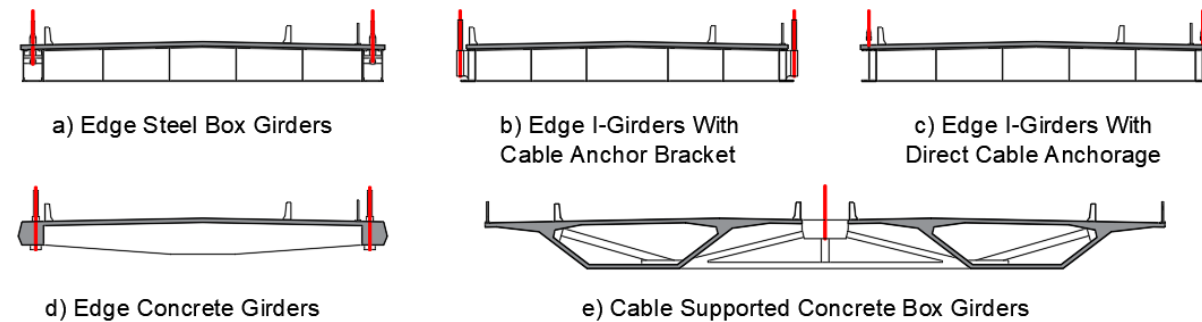


Fig. 2.17 – Cable Supported Bridges

For cable-stayed bridges steel I-girders are commonly used. The cables are anchored either in brackets with anchor pipes (“rocket launchers”) attached to the side of the edge girders (Fig. 2.17b) or in fin plates that are in line with the web of the edge girder (Fig. 2.17c). With an all-concrete deck cables are anchored below the post-tensioned edge girder (Fig. 2.17d). Deck segments would be either cast-in-place on form travelers or would use precast elements to reduce on-site work and to increase the rate of construction.

With a single cable plane a torsionally stiff deck is needed to prevent excessive twisting of the cross section under asymmetric loading. This requires a deep, closed box section, either in the form of two linked parallel boxes (Fig. 2.17e) or as a single box (not shown).

2.9 Approach Bridge Type

The approach bridges would most efficiently use a standard bridge type, i.e. steel or prestressed concrete stringer bridges (Figures 2.18a, b). The concrete option is feasible for spans of up to about 160 feet, while a typical steel plate girder is suitable for spans of up to 300 feet and even greater. Steel tub girders would be used if the aesthetically cleaner lines of a closed box are desired or if plan curvature of the bridge requires greater torsional stiffness (Fig. 2.18c). The concrete box girder option would be advantageous in the context of precast segmental construction if similar concrete boxes are also used for the main span (2.18d).

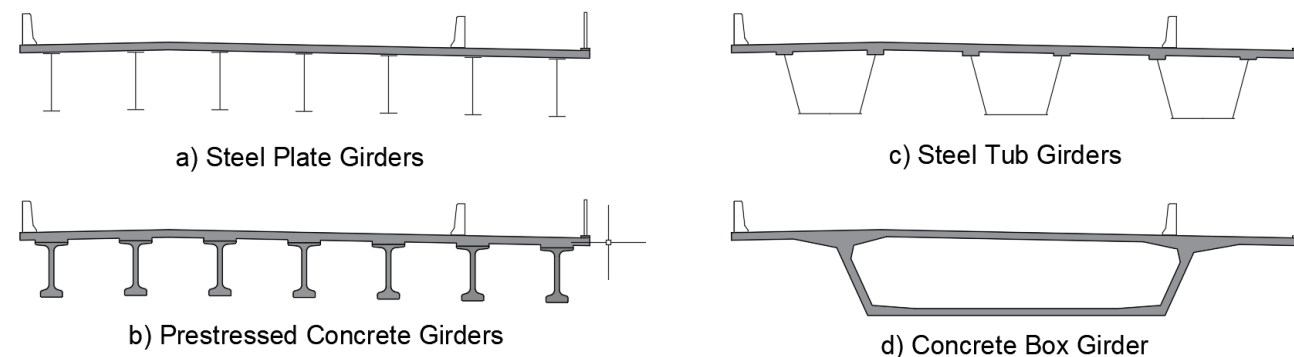


Fig. 2.18 – Approach Bridge Types

3 SCREENING CRITERIA

3.1 Introduction

Figure 3.1 lists the evaluation criteria used for initial screening of the bridge design parameters. The criteria have been divided into ten major groups with subgroups for each category.

EVALUATION CRITERIA		STRUCTURAL REDUNDANCY	Fracture-Critical Members Failure-Critical Members
INITIAL COST	Main Span Structure	INSPECTION & MAINTENANCE	Access Frequency
	Main Span Foundations		DURABILITY
	Overall	WIND RESPONSE	
HIGHWAY GEOMETRICS	Grade/Length		
	Footprint	CONSTRUCTION	Appearance/Signature Bike/Pedestrian Path
	Horizontal Tangent Length		MAINSpan FOOTINGS
CONSTRUCTION	Phasing		
	Duration		
	Constructability		
	Impact on Canal Traffic		
	Maintenance of Traffic		
	Environmental Impact		

Fig. 3.1 – Screening Criteria

3.2 Initial Cost

Initial cost represents a qualitative evaluation of costs for main-span superstructure, main span foundations, and approaches. It is informed by the understanding that longer span length translates into greater superstructure cost, but that this is tempered by easier foundation and substructure construction if it can be performed from land. Approach span costs are affected by the footprint of the structure and the associated Right of Way impacts, span lengths, and total structure length and grade.

3.3 Highway Geometrics

3.3.1 Grade and Length

The main span girder depth affects the vertical profile of the new bridges due to the need for relatively steep climbs to achieve the desired clearance over the canal. Figure 3.2 illustrates schematically how additional girder depth necessitates either longer or steeper approaches. For example, assuming  $L = 800$  ft and  $\alpha = 4\%$ , a difference of 12 foot in girder depth translates to either 300 foot longer approaches on both sides or 1.5% steeper approach grades.

Of the bridge types considered, the cable supported options with two cable planes (arch, cable-stayed, suspension) and the truss offer the least girder depth, controlled by the depth needed for the floorbeams. A single-plane cable-stayed bridge and in particular the box girder options require significantly deeper girders.

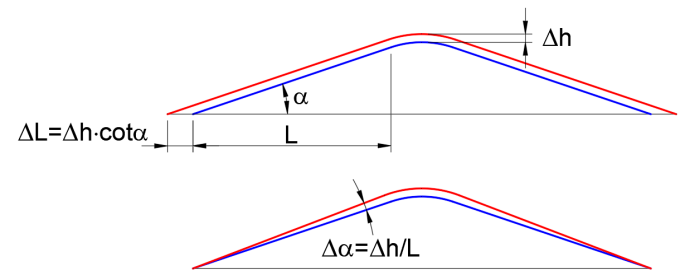


Fig. 3.2 – Influence of Girder Depth on Highway Alignment

3.3.2 Footprint

Alternatives with two separate bridges will have a larger footprint than a single bridge due to the need for an adequate gap between the individual structures. However, with two separate bridges and phased construction it is possible to overlap the footprint for the existing structure, thereby minimizing additional Right of Way impacts.

3.3.3 Horizontal Tangent Length

A horizontal tangent highway alignment is required over the length of the main span and any side or anchor spans. The exception are box girder bridges which can accommodate a moderate plan curvature ( $R > 2500$  ft) due to their great torsional stiffness. The length of the side spans is typically set to avoid uplift on the anchor piers under dead load and under live-load concentrated on the main span. Alternatively, with shorter side spans a tie-down mechanism in the form of vertical cables, inverted bearings, or ballast can be employed to resist uplift. With these considerations typical side span lengths range from 40% to 60% of the main span length. The arch option with traditional piers does not require anchor spans. The requirement for longer horizontal tangent lengths on some bridge types may preclude certain desirable highway alignments.

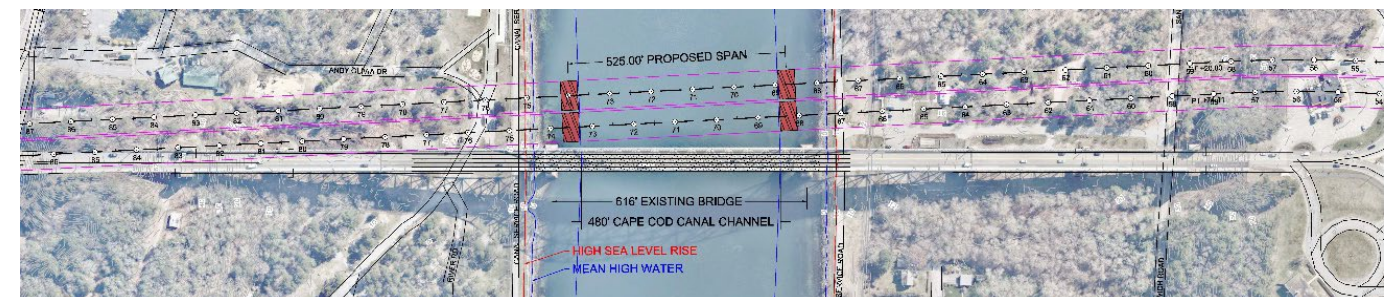
3.4 Main Span Footings

Four different main span lengths were considered as shown in Figure 3.3. The shortest possible span is 525 feet, dictated by the minimum required horizontal clearance of 480 feet between the edges of the footings (Fig. 3.3a). The 616-foot span option equals the span length of the existing bridges, thereby maintaining the status quo for channel operations (b). With an 820-ft span the new piers are located entirely on land with room to reroute the service roads between channel banks and piers (d). The 700-ft span alternative locates the piers between the service road and the canal, into the rip rap slope but above the low tide line (c). The footing location is evaluated with respect to impact on canal traffic and the potential for scour in this category and with respect to constructability in the Construction category. Bridge and approach roadway locations and alignments shown in the figure are for discussion purposes only. No determination has been made regarding future roadway alignment and bridge locations.

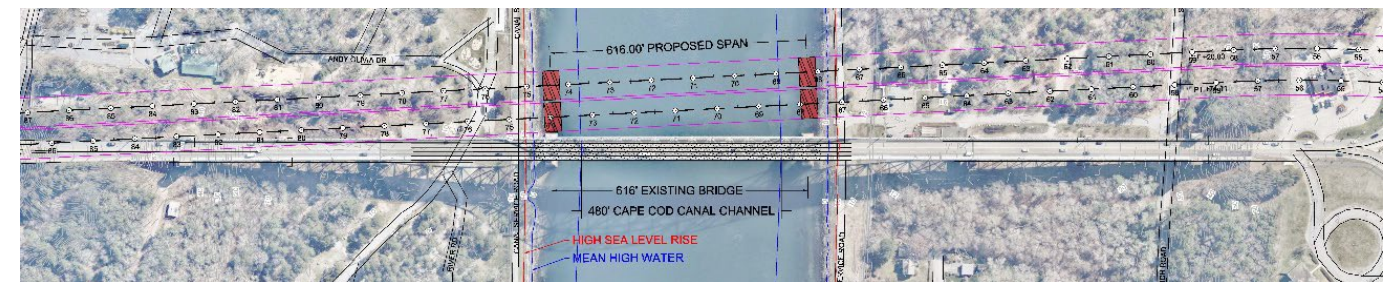
3.5 Construction

3.5.1 Phasing

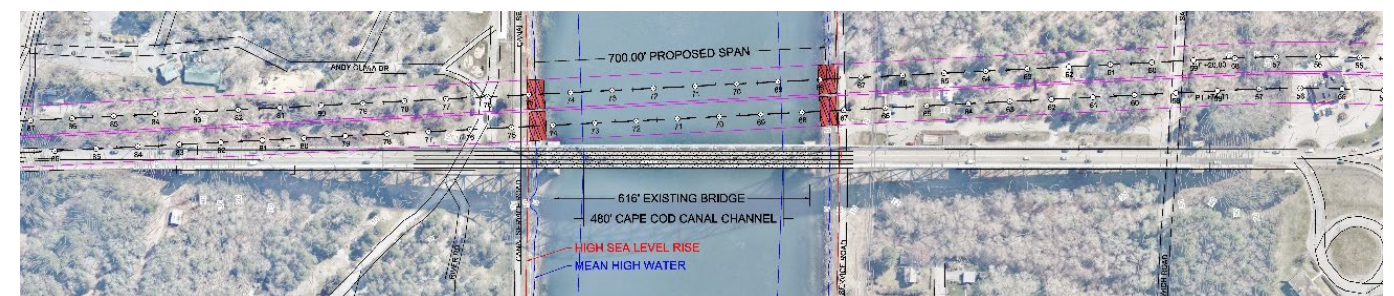
A single bridge accommodating both northbound and southbound traffic and the shared-use path becomes quite wide. Therefore, an alternative with separate structures for each direction is advantageous because it uses smaller construction elements and in addition gives the possibility of erecting northbound and southbound structures in separate phases (Fig. 3.4). With this approach during Phase 1 a new bridge is constructed parallel to the existing structure. Upon completion of Phase 1 all traffic is shifted to the new bridge with a temporary lane configuration. During Phase 2 the old bridge is dismantled and the second structure is erected in its place. The last step is to route traffic onto separate northbound and southbound structures and to configure the Phase 1 bridge for one-way traffic.



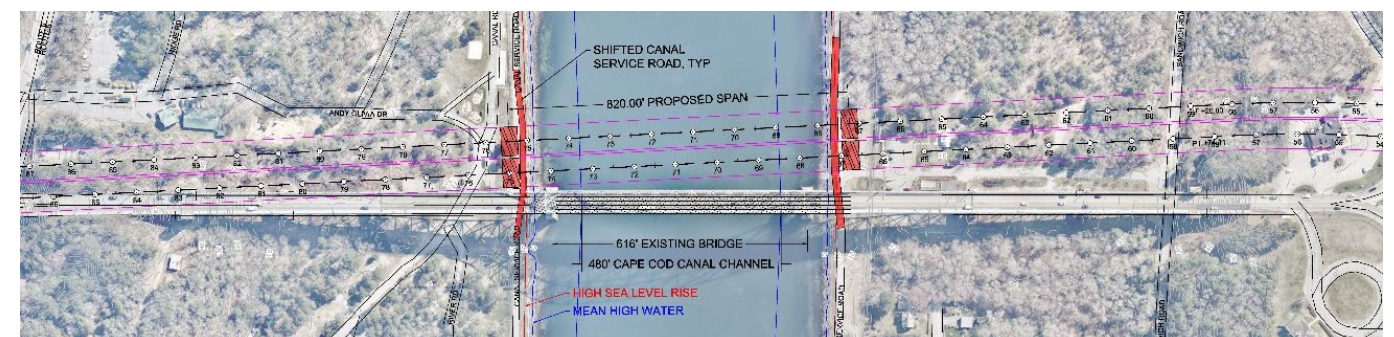
a) 525-ft Span



b) 616-ft Span



c) 700-ft Span



d) 820-ft Span

Fig. 3.3 – Main Span Footing Location Alternatives

3.5.2 Duration

When evaluating the impact of construction schedule, a distinction must be made between time required to take the existing bridge off line and time required for overall completion of the project. With phased construction a new structure, albeit in temporary configuration, would be available more quickly than with single-stage construction, however, overall construction time might be longer. Conversely, single-phase construction might shorten the overall schedule, but the existing bridge would need to remain in service longer.

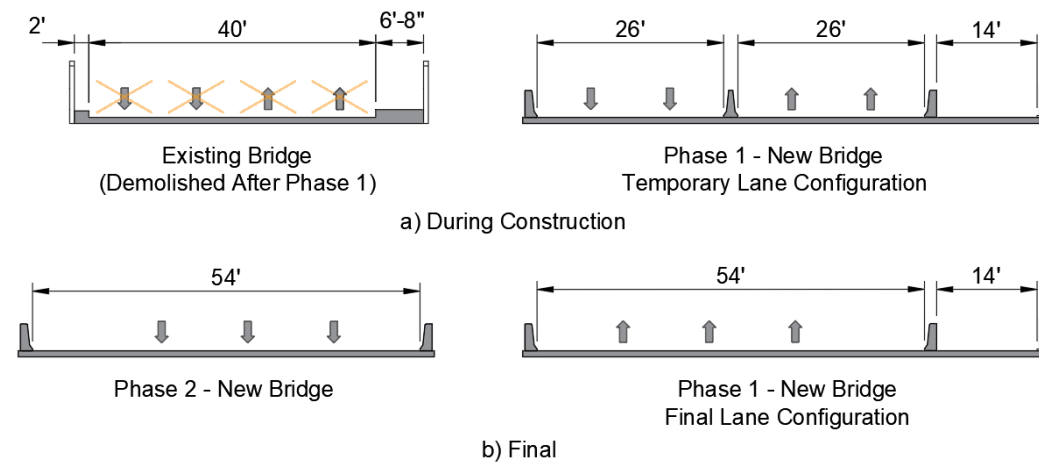


Fig. 3.4 – Phased Construction

3.5.3 Constructability

The main span superstructure construction method is dictated by the bridge type (Fig. 3.5). A post-tensioned concrete box girder would be constructed as balanced cantilevers with cast-in-place concrete placed into form travelers. A cable-stayed bridge would be constructed from short prefabricated elements delivered by barge or over the previously erected bridge. A tied arch can be prefabricated on shore as a complete unit, delivered by barge, and lifted into position during a short (approximately 48 hours long) closure of the canal. The Delta frame configuration is advantageous with this scheme, because it avoids interference between arch and piers during the lifting operation and greatly shortens the length of the arch for float-in and lifting. Alternatively, tied arches and trusses can be stick-built on site. This option requires temporary falsework in the canal during erection until the structure has become self-supporting. The opening between falsework towers cannot exceed approximately half the span length, i.e. 350 to 400 feet for the longer span alternatives.

Foundation construction in the canal requires a temporary trestle bridge or a causeway (Fig. 3.6). To avoid these elements the foundations can be placed entirely on land or just at the edge of the canal. Except for the land option, all of these alternatives require a braced cofferdam with a tremie seal to provide a dry work area for foundation construction.

3.5.4 Impact on Canal Traffic

All alternatives maintain the minimum required navigational clearances. Therefore, fixed structures needed to facilitate foundation construction, e.g. a trestle bridge, would have minimal impact on canal traffic. Some coordination would be required to accommodate material barges and barge-mounted cranes needed during this stage.

Cantilever superstructure construction (cable-stayed or box girder bridge) using prefabricated steel or concrete elements would have short-term impacts at the work front as segments are lifted off the delivery barge, at a frequency of typically once a week or every other week. Lifting an entire arch span would require closure of the complete channel for the duration of the operation, approximately 48 hours per bridge. Falsework for stick-building would reduce the horizontal clearance at the bridge site for the entire duration of superstructure construction. On the other hand, balanced cantilever construction of the post-tensioned concrete box girder option takes place entirely from above and does not affect canal traffic.



Fig. 3.5 – Main Span Superstructure Construction Methods



Fig. 3.6 – Foundation Construction

### 3.5.5 Maintenance of Traffic

With phased construction a new bridge would come on line quickly and provide about the same level of service as the existing structure. This stage would persist for about two years while the old bridge is dismantled and a new structure erected in its place. With single-stage construction the existing bridge needs to remain in service until the new structure is completed in its entirety.

### 3.5.6 Environmental Impact

This assessment favors alternatives that minimize impact to the waterway (i.e. the longer span options) and the ROW needs (i.e. phased construction with the second phase located within the alignment of the existing bridge).

## 3.6 Structural Redundancy

The AASHTO Bridge Design Specifications define a fracture-critical member as *a steel primary member or portion thereof subject to tension whose failure would probably cause a portion of or the entire bridge to collapse*. Typically, truss chords and diagonals in tension, tie girders of tied arches, and floorbeams spaced greater than 12 feet would be classified as fracture-critical (Fig. 3.7). Such members are subject to special fabrication and material quality and testing requirements. Most importantly, when in service fracture-critical members must be inspected at arm's length every other year.

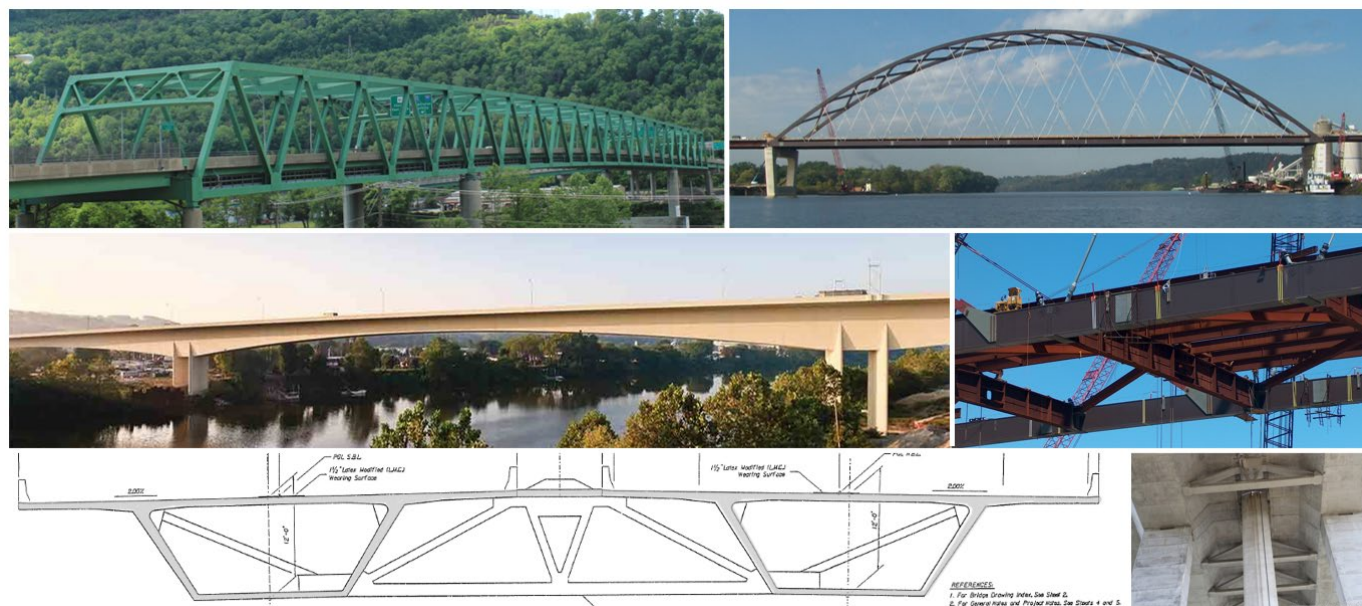


Fig. 3.7 – Structural Redundancy

With network tied arches the tie girders can tolerate loss of moment capacity due to the beneficial truss-like effect of the crossing hanger cables. Furthermore, with closely spaced cables loss of one or several cables can be easily accommodated by the structure. To achieve tie girder redundancy for axial load, typically the tie girder is built up of four individual plates bolted together at the corners and designed to withstand loss of any one of these plates. Currently the FHWA does not recognize such internal redundancy as effective, but there is a large and increasing body of research suggesting that this detail is indeed a valid approach to prevent complete failure of the member.

Even though not defined in the current bridge design specifications, members in compression and made of concrete can be just as critical as tension members in steel. Examples of such failure-critical components include the concrete

truss system linking individual boxes for certain single-plane cable-stayed bridge types (Fig. 3.7, bottom panels) and the prestressing tendons in post-tensioned concrete box girders.

## 3.7 Inspection & Maintenance

Inspection and maintenance considerations favor the simpler box girder alternative which avoids structural components above deck that are exposed to the elements and difficult to reach for inspection (Fig. 3.8). For tied arch bridges the accessible box section typically used for the tie girders ensures good inspectability of the lower anchorages and of the interior of the girders (Fig. 3.8, left picture).

The maintenance and redundancy criteria also lead to a more favorable assessment of the options with two separate structures, and particularly those where northbound and southbound bridges are identical (Fig. 2.5b). This arrangement allows for complete closure of one of the bridges while still accommodating four travel lanes and a shared-use path on the second bridge if the barriers are reconfigured accordingly.



Fig. 3.8 – Inspection and Maintenance

## 3.8 Durability

Hangers and stay-cables are exposed and highly stressed elements. Normally cable replacement is anticipated to be required at least once during the life of the bridge. Modern cable-supported bridges are designed to facilitate such cable replacement using light equipment while maintaining the full traffic capacity. Post-tensioning tendons are better protected than stay cables, either as external tendons running inside the box, or as internal tendons embedded in the concrete cross section. With balanced cantilever construction most of the tendons would be internal to deck and bottom slab and grouted and, therefore, would not be replaceable. However, some states are experimenting with substituting a flexible wax filler for the cement grout to allow for tendon replacement. In addition, it is standard practice to make provisions for the installation and anchorage of future tendons. A concern

about durability issues resulting from poor tendon grouting has emerged over the past two decades and has been addressed by industry through the development of stringent installation and material testing requirements and a certification program for grouting technicians. An advantage of balanced cantilever construction is that it requires a large number of short tendons, in excess of one hundred for the present case, so that the post-tensioning system has significant redundancy.

For conventional stringer bridges it is sometimes necessary to replace the bridge deck while the girders can be reused. This is relatively straight forward because the girders are typically designed to support the weight of the deck in their non-composite condition. Similarly, deck replacement is also possible for the truss alternative and for the network tied arch options described above. It is more difficult and less economical for cable-stayed bridges, because most efficiently in this application the concrete deck would be designed to participate in the transfer of the large axial forces introduced into the girder by the horizontal component of the cable forces. For the box girder alternative the deck is an integral part of the cross section and cannot be replaced. Prestressing the deck in both directions to limit crack widths under service loads, use of corrosion-resistant reinforcement, provision of additional cover and allowance for a future wearing surface, and installation of a wearing surface and waterproofing membrane during initial construction are all effective means to achieve a service life of the bridge deck compatible with the rest of the structure and thus eliminates the need to provide for future bridge deck replacement.

### 3.9 Wind Response

The Cape Cod Canal is located at a site subject to high wind loads with design three-second wind gusts of 130 mph (Fig. 3.9). Wind pressure is proportional to the square of the wind speed and increases with height above ground. Some tower shapes and configurations are more efficient to resist these wind forces than others. The cables themselves are vulnerable to wind and wind-rain induced vibrations, and with light structures the entire deck can experience vibrations ranging from the annoying to the catastrophic. With parallel structures there are also down-wind effects where the wake of the windward structure affects the leeward structure. The stiffer a structure the less susceptible it is to dynamic effects. For the alternatives considered here this means that a concrete box girder bridge will have superior performance to a truss, followed by the tied arch options, cable-stayed bridges, and finally the suspension bridge. Steel box girder bridges are less favorable than concrete boxes due to their sensitivity to vortex-shedding-induced oscillations.

All alternatives will be subject to wind tunnel studies to verify their performance and to determine wind force coefficients for drag and uplift. With a cable-stayed bridge dampers will likely be required to suppress stay-cable vibrations. Network tied arches have steeper and shorter cables which typically are less vulnerable to excitation and rarely require dampers. For flexible bridge decks it may be necessary to make aerodynamic improvements along the edge girders over part of the bridge length to improve the wind flow around the deck.

### 3.10 Snow and Ice response

For alternatives with structure above the deck, under certain weather conditions ice drop onto the roadway below has been an issue for a number of recently completed bridges (Fig. 3.10). This is particularly true for cable-stayed bridges with ice falling off the cables. It has been less of a problem with more rigid components, i.e. upper lateral bracing or arch ribs. The weather conditions causing ice drop are predictable and can be monitored via a weather station installed at the bridge site, making it possible to close exposed lanes as needed prior to the event. Alternatively, active measures are under development, e.g. rotating stay pipes to reduce excessive ice build-up on stay cables.



Fig. 3.9 – Wind Response



Fig. 3.10 – Ice Drop

### 3.11 Community

Screening criterion “Community” evaluates the potential of the bridge type to become a signature bridge for the site and the experience for pedestrians and bicyclists. Fig. 3.11 contrasts a number of representative bridge types. While all of them can be shaped and detailed with aesthetic appeal in mind, some of these structure forms are more visible and dominant than others. For example, a box girder bridge may appeal with its understated elegance, while a cable-stayed bridge with its tall towers would be visible from a great distance. The evolution of LED lighting facilitates illumination that can even be programmed to display varying light patterns.



Fig. 3.11 – Bridge Aesthetics

Pedestrian and bicyclist experience is influenced by the separation from vehicular traffic, access to the bridge, and by the flow of both bicyclists and pedestrians in the paths provided. The option to provide two dedicated paths instead of a single shared-use path in anticipation of heavy use and concerns about cyclist speed with the steep grades has been discussed in Section 2.4. The parameters for design of the shared-use path are under development in conjunction with the highway design.

Separation from vehicular traffic can be enhanced by placing the path outside a cable plane or on a separate elevated structure (Fig. 2.6). An ancillary consideration, which does not affect bridge type selection, is access to the bridge structure from the canal service roads below and the street network further in from shore. These access considerations will be considered in the next design phase, in conjunction with preliminary highway design alternative analysis.

**4 SCREENING MATRICES**

**4.1 Introduction**

Evaluation of the bridge design parameters employed an unscaled, qualitative rating scheme to facilitate initial screening. The ranking is based on a simple color code as depicted in Figure 4.1. This gives a quick visual indication of the desirability of a certain feature. Of particular importance are the triple-red and triple-green ratings, indicating options that are removed from further consideration or that are conclusively carried to the next evaluation phase,

respectively. The evaluation matrices were completed in consultation with representatives of MassDOT, Army Corps of Engineers, and FHWA and they are included in Appendix A of this report. The matrices contain notes briefly explaining the particular ratings. The following sections expand on these notes with additional information supporting the “most favorable” and the “unfavorable” assessments. These same criteria will be used to perform more detailed, quantitative and scaled ranking of bridge alternatives in future phases of preliminary design.

CRITERIA	ALT. 1	ALT. 2	
INITIAL COST	●●	●●●	
HIGHWAY GEOMETRICS	●	●●	
MAINSpan FOOTINGS	●●●	●●	
CONSTRUCTION	●●	●	
STRUCTURAL REDUNDANCY	●●	●●●	
INSPECTION & MAINTENANCE	●●	●●●	
DURABILITY	●●	●●●	
WIND RESPONSE	●	●●	
SNOW & ICE RESPONSE	●●	●●	
COMMUNITY	●●	●●	

●●● Most Favorable  
 ●● Favorable  
 ● Neutral  
 ●● Less Favorable  
 ●●● Unfavorable  
 ●● Not Rated

Fig. 4.1 – Rating Scheme Format

**4.2 Main Span Length**

The discussions with the Army Corps of Engineers revealed that the shortest-span option (525 feet) is not acceptable and that the longer-span options (700 feet and 820 feet) are favored. The higher superstructure cost with the longer spans was judged to be partially compensated for by the easier access for foundation construction.

**4.3 Deck Configuration**

A clear preference for two separate structures emerged from the evaluation due to the opportunity for phased construction, the shortest time to decommissioning of the existing bridge, the possibility to overlap the new bridge alignment with the existing bridge footprint, and the operational flexibility during the service life of the new bridge. The preference was not strong enough, however, to completely eliminate single-bridge options from further consideration.

**4.4 Single Bridge**

Amongst the single-bridge options a cable-stayed alternative with a single, central cable plane was rated “unfavorable”. This assessment was based on concerns about the exceptionally great width (approximately 145 feet) of the deck required with this arrangement and about the asymmetric loading from a one-sided shared-use path.

**4.5 Separate Bridges**

Amongst the parallel-bridge options an alternative with a link slab connecting two independent structures and carrying the shared-use path was eliminated from further considerations. This decision was driven by an assessment that the link slab would perform poorly during service and that this arrangement would not allow for pedestrian access during phased construction.

#### 4.6 Medium-Long-Span Bridge Types

This matrix groups the 525, 616, and 700-ft span options together, as they all have similar characteristics. Only the latter two are relevant, however, since the 525-ft span option is eliminated by channel operation considerations. Amongst the bridge type alternatives presented here, tied arches and tied arches with Delta frames are rated very favorably due to the possibility of accelerated bridge construction with the arch being fabricated offsite while construction of foundations and substructure progresses simultaneously. The haunched concrete box girder option was rated favorably due to the simplicity of the structure with the fewest items to maintain and inspect.

The truss option was eliminated from further consideration because tension elements in trusses are considered fracture-critical, which triggers a requirement for costly biennial inspections. The single-tower cable-stayed bridge option was eliminated because the site conditions permit construction of two towers, resulting in a much more efficient structural system.

#### 4.7 Long-Span Bridge Types

Bridge types considered for the 820-ft span alternative are similar to the medium-long-span bridge types with the addition of a suspension bridge option and the modification of the truss option from constant to variable depth. As for the shorter spans and for the same reasons, the truss bridge and the single-tower cable-stayed bridge alternatives were rated “unfavorable”. The suspension bridge option was also eliminated from further consideration since it is better suited for much longer spans.

Among the tied arch options only the arrangement with Delta frames was advanced for the long-span range, since this alternative reduces the length of the arch span and thus retains the feasibility to float in the prefabricated arch structure. With a longer arch, the limited channel width cannot accommodate the float-in operation and construction on site with falsework in the canal would be required, which was deemed unacceptable.

#### 4.8 Cable-Stayed Bridge Towers

The matrix evaluating cable-stayed bridge towers comprises arrangements with two tower legs either in the form of an H (or V), an A, or an inverted Y. All of these configurations were deemed feasible and the prescreening process did not eliminate any of them.

#### 4.9 Cable-Stayed Bridge Pylons

The matrix evaluating cable-stayed bridge pylons comprises arrangements with a single tower leg and one, two, or three cable planes. Only the alternative with three cable planes was eliminated due to the associated challenges of controlling the cable forces with this indeterminate floorbeam support system. It is noted that the pylon configurations only work in conjunction with a single bridge structure.

#### 4.10 Arch Rib Configurations

The arch rib configurations include vertical ribs with upper lateral bracing, free-standing vertical ribs, and basket handle rib arrangements. Considering the high wind forces at this site, free-standing ribs were ruled out. In addition, an alternative with three ribs and three cable planes was rated “unfavorable” due to the expected difficulties of apportioning the cable forces with the resulting indeterminate floorbeam support.

#### 4.11 Haunched Box Girder Bridges

For the haunched girder alternatives only the solution with two separate post-tensioned concrete box girders was advanced. A single concrete box, either with a single cell or two cells, was considered not feasible due to the great deck width (approximately 129 feet) required to accommodate both roadways and the shared-use path. An alternative using two separate steel boxes was also rated “unfavorable” in view of expected high fabrication costs and lack of recent US experience with this type of structure at the span ranges considered.

#### 4.12 Deck Girder Types

The matrix evaluating deck girder options is primarily concerned with deck materials, edge girder configurations, and box girder configurations. None of the criteria were rated strongly enough to become decision drivers (i.e. received a triple-red or triple-green rating), however, a preference emerged for closed steel box edge girders with the tied arch alternatives and an open steel edge girder with the cable-stayed bridge alternatives.

#### 4.13 Approach Bridge Types

For the approach bridge type assessment the ratings in the corresponding decision matrix reflects the expectation that a traditional steel-plate, multi-girder arrangement can best meet the span length requirements for the approaches and provide the necessary flexibility to tie in ramps. An alternative with steel tub girders was also rated highly mostly for aesthetic reasons in view of its cleaner lines.


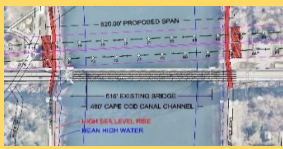

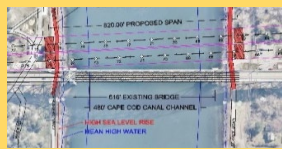
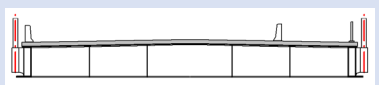
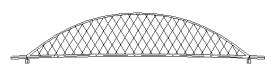
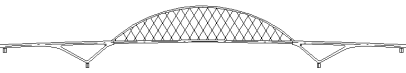
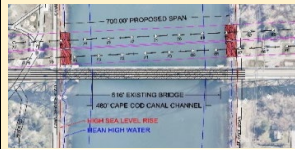
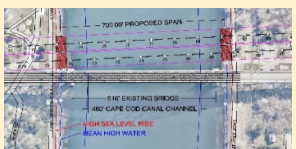
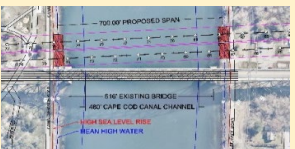
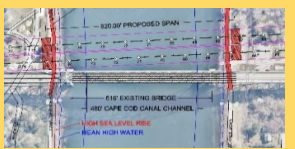
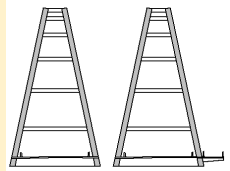
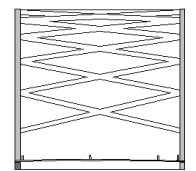
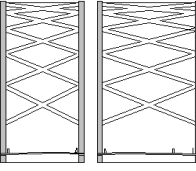
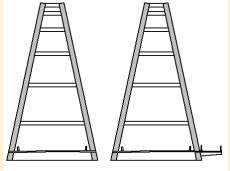
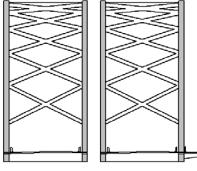
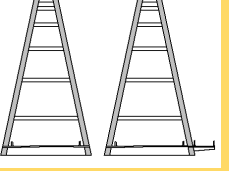
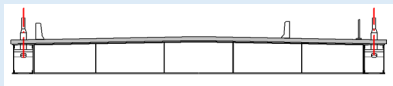
### 5 PROPOSED CONFIGURATIONS

Informed by the rating matrices a set of bridge options comprising the most promising and favorable features was selected as follows:



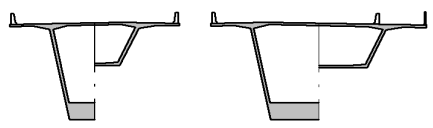
- Cable-stayed bridge alternatives with a single deck and a 820-ft span and with separate decks at 700 feet and 820 feet, all with various tower configurations.
- A post-tensioned concrete box girder alternative comprising twin bridges with a 700-ft span.
- Network tied arch options, either with traditional piers supporting a 700-ft span or with Delta-frame configuration for 700 and 820-ft main spans with various rib and deck configurations.

Table 5.1 shows summary information for each alternative and preliminary renderings are included in Appendix A. Table entry and corresponding rendering are identified by the matching label (e.g. “CS1” for Cable-Stayed Bridge Alternative 1). It is noted that these renderings have the character of massing studies and depict preliminary and tentative proportions. Further sharpening of the bridge type screening will occur during the next phase of the study in conjunction with the evolving highway design.

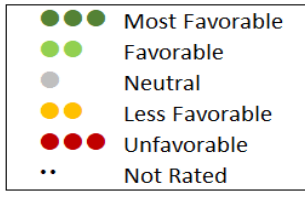
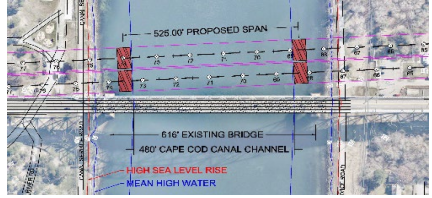
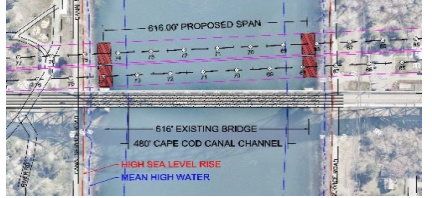
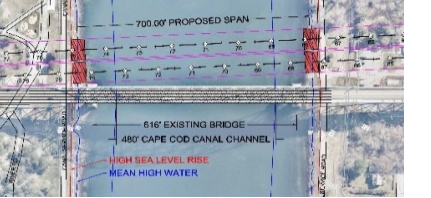
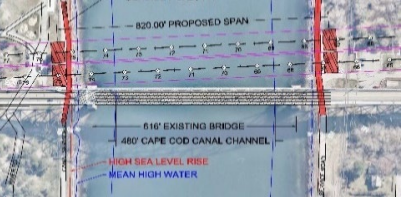


TABLE 5.1 - PROPOSED BRIDGE TYPES AND CONFIGURATIONS FOR FURTHER EVALUATION											
Type	Two-Tower Cable Stayed with Two Cable-Planes 										
Label	CS1	CS2	CS3	CS4	CS5	CS6	CS7	CS8	CS9	CS10	CS11
Deck	Single Deck					Separate Decks					
Span	820 feet 					700 feet 			820 feet 		
Tower	H	V	Single A	Single Y	Pylon	Separate H's	Separate A's	Merged A's	Separate H's	Separate A's	Merged A's
Girder	Edge Steel I-Girder 										
Type	Tied Arch 		Tied Arch with Delta Frames 								
Label	TA1	TA2	TA3	TA4	TA5	TA6					
Deck	Separate Decks		Single Deck		Separate Decks						
Span	700 feet 		700 feet 		700 feet 			820 feet 			
Rib	Basket Handle Ribs 		Vertical Ribs 		Vertical Ribs 		Basket Handle Ribs 		Vertical Ribs 		Basket Handle Ribs 
Girder	Edge Steel Box Girder 										

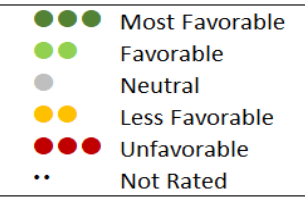
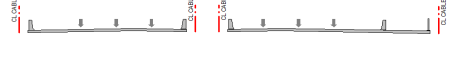
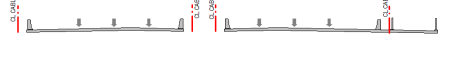
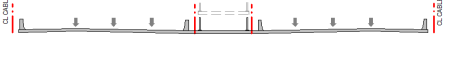
Type	Box Girder 	
Label	BG1	
Deck	Separate Decks	
Span	>700 feet 	
Girder	Post-Tensioned Concrete 	

## APPENDIX A – SCREENING MATRICES

MAIN SPAN LENGTH		Minimum - 525 ft		Status-Quo - 616 ft		Shore Line Piers - 700 ft		Land Piers - 820 ft	
									
EVALUATION CRITERIA		Rating	Notes	Rating	Notes	Rating	Notes	Rating	Notes
INITIAL COST	Main Span Structure	●●	Lowest superstructure cost.	●	Intermediate superstructure and foundation costs.	●	Intermediate superstructure and foundation costs.	●●	Highest superstructure cost.
	Main Span Foundations	●●	Highest foundation cost, designed for vessel impact, construction access, requires cofferdam.	●●	High foundation cost - access, cofferdam.	●	Close to land, but still requires cofferdam in tidal zone.	●●	Best accessibility for foundation construction.
	Overall	●●		●●		●●		●●	
HIGHWAY GEOMETRICS	Grade/Length	●●		●●		●●		●●	
	Footprint	●●		●●		●●		●●	
	Horizontal Tangent Length	●●		●●		●●		●●	
MAINSpan FOOTINGS	Vessel Impact	●●●	Not acceptable for canal operations.	●●	Small vessels and shallow draft barges.	●●●	Large vessels ground out, small vessels only.	●●●	Not possible.
	Scour	●●		●●	No significant scour with existing structure.	●●	Armored slope.	●●●	Not possible.
CONSTRUCTION	Phasing	●●		●●		●●		●●	
	Duration	●	Pier construction from water.	●	Pier construction from water.	●	Pier construction from water.	●	More difficult superstructure.
	Constructability	●●	Pier construction from trestle bridge.	●	Trestle bridge or causeway.	●●	Pier construction from land.	●●	Pier construction on land.
	Impact on Canal Traffic	●●	Most channel fouling.	●		●●	No channel fouling.	●●●	No channel fouling.
	Maintenance of Traffic	●●		●●		●●		●●	
	Environmental Impact	●●	Pier footing in water.	●●	Pier footing in water.	●	Pier footing tucked into shore line.	●●	Pier footing on land.
STRUCTURAL REDUNDANCY	Fracture-Critical Members	●●		●●		●●		●●	
	Failure-Critical Members	●●		●●		●●		●●	
INSPECTION & MAINTENANCE	Access	●●		●●		●●		●●	
	Frequency	●●		●●		●●		●●	
DURABILITY	Protection	●●		●●		●●		●●	
	Replacement	●●		●●		●●		●●	
	Monitoring	●●		●●		●●		●●	
WIND RESPONSE	Structural Efficiency	●●		●●		●●		●●	
	Dynamic Effects	●●		●●		●●		●●	
SNOW & ICE RESPONSE	Bridge closures	●●		●●		●●		●●	
	Monitoring/Deicing	●●		●●		●●		●●	
COMMUNITY	Appearance/Signature	●●		●●		●●		●●	
	Bike/Pedestrian Path	●●		●●		●●		●●	

DECK CONFIGURATION		Single Deck/Single Path		Single Deck/Two Paths		Separate Decks/Single Path		Separate Decks/Two Paths	
EVALUATION CRITERIA		Rating	Notes	Rating	Notes	Rating	Notes	Rating	Notes
INITIAL COST	Main Span Structure	●	Highest floorbeam cost, but least number of ribs or cable planes.	●	Highest floorbeam cost, but least number of ribs or cable planes.	●	Least floorbeam costs, but requires more ribs or cable planes.	●	Least floorbeam costs, but requires more ribs or cable planes.
	Main Span Foundations	**		**		**		**	
	Overall	**		**		**		**	
HIGHWAY GEOMETRICS	Grade/Length	●●	Greater structure depth requires steeper or longer approach.	●●	Greater structure depth requires steeper or longer approach.	●●	Least floorbeam depth.	●●	Least floorbeam depth.
	Footprint	●	Smaller constructed footprint, but may require more takings.	●	Smaller constructed footprint, but may require more takings.	●●	Greatest flexibility for overlap with existing alignment.	●●	Greatest flexibility for overlap with existing alignment.
	Horizontal Tangent Length	**		**		**		**	
MAINSpan FOOTINGS	Vessel Impact	**		**		**		**	
	Scour	**		**		**		**	
CONSTRUCTION	Phasing	●●	Not an option.	●●	Not an option.	●●●	Phase 1: 2 x 30-ft roadways	●●●	Phase 1: 2 x 27-ft roadways
	Duration	●		●		●●	Old bridge decommissioned soonest.	●●	Old bridge decommissioned soonest.
	Constructability	●●		●●		●●	More repetitive, smaller pieces.	●●	More repetitive, smaller pieces.
	Impact on Canal Traffic	**		**		**		**	
	Maintenance of Traffic	●	Staged tie-in to existing highway more difficult.	●	Staged tie-in to existing highway more difficult.	●●	Allows phased construction.	●●●	Most flexible-either structure can be configured for two-way traffic during construction and during life of structure.
	Environmental Impact	●	Smaller constructed footprint, but may require more takings.	●	Smaller constructed footprint, but may require more takings.	●●	Greatest flexibility for overlap with existing alignment.	●●	Greatest flexibility for overlap with existing alignment.
STRUCTURAL REDUNDANCY	Fracture-Critical Members	**		**		**		**	
	Failure-Critical Members	●		●		●●	Each structure can operate independently and carry two-way traffic, but no path.	●●●	Each structure can operate independently and carry two-way traffic and a path.
INSPECTION & MAINTENANCE	Access	**		**		**		**	
	Frequency	**		**		**		**	
DURABILITY	Protection	**		**		**		**	
	Replacement	**		**		●●	Each structure can operate independently and carry two-way traffic, but no path.	●●●	Most flexible-either structure can be configured for two-way traffic during construction and during life of structure.
	Monitoring	**		**		**		**	
WIND RESPONSE	Structural Efficiency	**		**		**		**	
	Dynamic Effects	●●	Better wind stability.	●●	Better wind stability.	●●	Need to address wake effects.	●●	Need to address wake effects.
SNOW & ICE RESPONSE	Bridge closures	**		**		**		**	
	Monitoring/Deicing	**		**		**		**	
COMMUNITY	Appearance/Signature	**		**		**		**	
	Bike/Pedestrian Path	**		**		**		**	

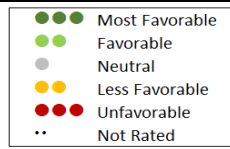
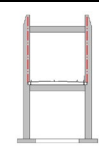
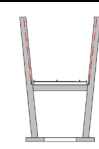

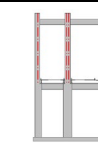
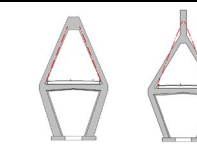
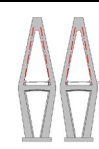

SINGLE BRIDGE DECK		Simple Span Floorbeam		Cantilever Floorbeam		Separate Pedestrian Level		Single Cable Plane	
									
EVALUATION CRITERIA		Rating	Notes	Rating	Notes	Rating	Notes	Rating	Notes
INITIAL COST	Main Span Structure	●	Largest floorbeam span.	●●	Reduced floorbeam span length.	●●	Additional cost for walkway support, transverse flyovers, and screens.	●●●	Requires torsionally stiff and deep deck girder to address eccentricity.
	Main Span Foundations	●		●		●●	Additional cost for walkway support and screens.	●	
	Overall	●●		●●		●●		●●	
HIGHWAY GEOMETRICS	Grade/Length	●		●		●●	Allows different grades for roadway and path.	●●	Deep structure increases approach length or grade.
	Footprint	●		●		●●	Smallest footprint.	●●	Closure strip/tower increases deck width.
	Horizontal Tangent Length	●●		●●		●●		●●	
MAINSpan FOOTINGS	Vessel Impact	●●		●●		●●		●●	
	Scour	●●		●●		●●		●●	
CONSTRUCTION	Phasing	●●		●●		●●		●●	
	Duration	●●		●●		●●		●●	
	Constructability	●●		●●		●●		●●	
	Impact on Canal Traffic	●●		●●		●●		●●	
	Maintenance of Traffic	●●		●●		●●		●●	
Environmental Impact	●●		●●		●●		●●		
STRUCTURAL REDUNDANCY	Fracture-Critical Members	●●		●●		●●		●●	
	Failure-Critical Members	●●		●●		●●		●●	
INSPECTION & MAINTENANCE	Access	●●		●●		●●		●●	
	Frequency	●●		●●		●●		●●	
DURABILITY	Protection	●●		●●		●●		●●	
	Replacement	●●		●●		●●		●●	
	Monitoring	●●		●●		●●		●●	
WIND RESPONSE	Structural Efficiency	●●		●●		●●		●●	
	Dynamic Effects	●●		●●		●●		●●	
SNOW & ICE RESPONSE	Bridge closures	●●		●●		●●		●●	
	Monitoring/Deicing	●●		●●		●●		●●	
COMMUNITY	Appearance/Signature	●●		●●		●●		●●	
	Bike/Pedestrian Path	●		●●	Cable plane creates barrier effect.	●●	Path offset from traffic.	●	

SEPARATE BRIDGE DECKS		Simple Span Floorbeams		Cantilever Floorbeam		Twins With Link Slab	
							
EVALUATION CRITERIA		Rating	Notes	Rating	Notes	Rating	Notes
INITIAL COST	Main Span Structure	●		●●	Reduced floorbeam span.	●●	Reduced floorbeam span.
	Main Span Foundations	●●		●●		●●	
	Overall	●●		●●		●●	
HIGHWAY GEOMETRICS	Grade/Length	●●		●●		●●	
	Footprint	●●		●●		●●	
	Horizontal Tangent Length	●●		●●		●●	
MAINSpan FOOTINGS	Vessel Impact	●●		●●		●●	
	Scour	●●		●●		●●	
CONSTRUCTION	Phasing	●●	2x30-ft roadways and 6-ft path in temporary configuration.	●	2x26-ft roadways and 14-ft path in temporary configuration.	●●●	2x26-ft roadways but no path in temporary configuration.
	Duration	●●		●●		●●	
	Constructability	●		●●	Path eccentricity complicates construction.	●●	Path adds another construction phase, durability of deck construction joints.
	Impact on Canal Traffic	●●		●●		●●	
	Maintenance of Traffic	●●		●●		●●	
	Environmental Impact	●●		●●		●●	
STRUCTURAL REDUNDANCY	Fracture-Critical Members	●●		●●		●●	
	Failure-Critical Members	●●		●●		●●	
INSPECTION & MAINTENANCE	Access	●●		●●		●●	
	Frequency	●●		●●		●●	
DURABILITY	Protection	●		●		●●	Complex behavior of link slab as it spans between twin superstructures.
	Replacement	●●		●●		●●	
	Monitoring	●●		●●		●●	
WIND RESPONSE	Structural Efficiency	●●		●●		●●	
	Dynamic Effects	●●		●●		●●	
SNOW & ICE RESPONSE	Bridge closures	●●		●●		●●	
	Monitoring/Deicing	●●		●●		●●	
COMMUNITY	Appearance/Signature	●●		●●		●●	
	Bike/Pedestrian Path	●		●●	Cable plane creates barrier effect.	●●	Path surrounded by traffic on both sides.

BRIDGE TYPE (525/616/700-FT)		Tied Arch		Tied Arch With Delta Frame		Truss		Two-Tower Cable Stayed		Single-Tower Cable Stayed		Box Girder	
EVALUATION CRITERIA		Rating	Notes	Rating	Notes	Rating	Notes	Rating	Notes	Rating	Notes	Rating	Notes
INITIAL COST	Main Span Structure	●●	Efficient off-site construction, least length of main span structure.	●●	Efficient off-site construction, but added complexity from Delta frames.	●	Slower construction.	●●	Lower end of efficient span range for this type of structure.	●●●	Inefficient structural system.	●●	Efficient and simple structural system.
	Main Span Foundations	**		**		**		**		**		●●	Heavy foundation.
	Overall	**		**		**		**		**		●●	Deeper superstructure requires longer or taller approaches.
HIGHWAY GEOMETRICS	Grade/Length	●●	Least main span girder depth. Shortest main span creates more flexibility for curved approaches.	●●	Least main span girder depth.	●●	Least main span girder depth.	●	Similar to arches and truss with two cable planes, similar to box girder with single cable plane.	●	Similar to arches and truss with two cable planes, similar to box girder with single cable plane.	●●	Extra approach structure length or grade due to main span girder depth.
	Footprint	**		**		**		**		**		**	
	Horizontal Tangent Length	●●	Main span only.	●●	Arch and Delta frame spans.	●●	Main and side spans.	●●	Main and side spans.	●●	Main and side span.	●●	Can accommodate moderate plan curvature.
MAINSpan FOOTINGS	Vessel Impact	**		**		**		**		**		**	
	Scour	**		**		**		**		**		**	
CONSTRUCTION	Phasing	**		**		**		**		**		**	
	Duration	●●●	Accelerated bridge construction with arch fabricated off-site and floated in.	●●●	Accelerated bridge construction with arch fabricated off-site and floated in.	●●	Significant portion of structure erected by stick building.	●	Accelerated construction by working from two towers simultaneously.	●●	Single work front and linear construction process.	●	Accelerated construction by working from two piers simultaneously.
	Constructability	●●	Arch floated in, complex lifting operation.	●●●	Arch floated in, Delta piers simplify lifting operation.	●●	Stick building with floated in drop-in span.	●	Repetitive construction cycle, but requires careful cable force and geometry control, tower construction.	●	Repetitive construction cycle, but requires careful cable force and geometry control, tower construction.	●●	Repetitive construction cycle.
	Impact on Canal Traffic	●●●	Single closure for each span lift.	●●●	Single closure for each span lift.	●	Barge operations near pier, one extended closure for drop-in lift	●	Periodic, partial obstructions for segment lift from barge (approximately 40 lifts/bridge)	●	Periodic, partial obstructions for segment lift from barge (approximately 40 lifts/bridge)	●●●	None.
	Maintenance of Traffic	**		**		**		**		**		**	
Environmental Impact	**		**		**		**		**		**		
STRUCTURAL REDUNDANCY	Fracture-Critical Members	●●	Fracture critical elements (ties, hangers, floorbeams) designed for system or internal redundancy.	●●	Fracture critical elements (ties, hangers, floorbeams) designed for system or internal redundancy.	●●●	Tension diagonals, tension chords designated as fracture-critical members.	●●	Hangers, floorbeams - designed for system or internal redundancy.	●●	Hangers, floorbeams - designed for system or internal redundancy.	●●●	No fracture critical members.
	Failure-Critical Members	●●	Improved rib stability due to network hanger arrangement.	●●	Improved rib stability due to network hanger arrangement.	●●	Any truss member.	●●	Stiffening girder.	●●	Stiffening girder.	●●	Post-tensioning tendons.
INSPECTION & MAINTENANCE	Access	●●	Accessible tie girders and ribs, snooper for under-deck, cherry picker for cables.	●●	Accessible tie girders and ribs, snooper for under-deck, cherry picker for cables.	●●	Snooper and cherry picker.	●	Accessible towers, snooper for under-deck, rope access for cables	●	Accessible towers, snooper for under-deck, rope access for cables	●●	Accessible box girder, snooper for under-deck, but cannot inspect internal tendons.
	Frequency	●	Typical cycle.	●	Typical cycle.	●●	Hands-on inspection of fracture-critical items at two-year intervals.	●	Typical cycle.	●	Typical cycle.	●●●	Typical cycle, fewest elements to inspect.
DURABILITY	Protection	●	Has vulnerable elements above deck. Metallized steel, partially prestressed precast deck panels.	●	Has vulnerable elements above deck. Metallized steel, partially prestressed precast deck panels.	●	Has vulnerable elements above deck. Metallized steel, concrete cover and corrosion resistant reinforcement.	●	Has vulnerable elements above deck. Metallized steel, partially prestressed precast deck panels.	●	Has vulnerable elements above deck. Metallized steel, partially prestressed precast deck panels.	●●	Fewest exposed elements, deck fully prestressed longitudinally and transversely, concrete cover and corrosion resistant reinforcement.
	Replacement	●●	Cables, deck overlay system, deck.	●●	Cables, deck overlay system, deck.	●	Deck overlay system, deck.	●	Cables, deck overlay system, typically not designed for deck replacement.	●	Cables, deck overlay system, typically not designed for deck replacement.	●●	Deck overlay system, deck replacement not possible.
	Monitoring	●	Cables.	●	Cables.	●	None required.	●	Cables.	●	Cables	●	None required.
WIND RESPONSE	Structural Efficiency	**		**		**		**		●●	Poor wind performance (effectively twice the span length)	**	
	Dynamic Effects	●	Requires wind tunnel studies.	●	Requires wind tunnel studies.	●	Potential for truss member vibrations.	●●	Requires wind tunnel studies.	●●	Requires wind tunnel studies.	●●	Negligible.
SNOW & ICE RESPONSE	Bridge closures	●	Uncommon.	●	Uncommon.	●	Uncommon.	●●	During critical climatic conditions.	●●	During critical climatic conditions.	●●	Uncommon.
	Monitoring/Deicing	●	Ice drop from rib-bracing.	●	Ice drop from rib-bracing.	●	Ice drop from top chord bracing.	●●	Ice drop from cables.	●●	Ice drop from cables.	●●	Uncommon.
COMMUNITY	Appearance/Signature	●●	Efficient, less height.	●●	Echoes appearance of existing structure.	●●	Utilitarian.	●●	Iconic.	●●	Iconic.	●	Understated elegance.
	Bike/Pedestrian Path	**		**		**		**		**		**	

BRIDGE TYPE (820-FT SPAN)		Tied Arch		Tied Arch With Delta Frame		Truss		Two-Tower Cable Stayed		Single-Tower Cable Stayed		Box Girder		Suspension Bridge	
EVALUATION CRITERIA		Rating	Notes	Rating	Notes	Rating	Notes	Rating	Notes	Rating	Notes	Rating	Notes	Rating	Notes
INITIAL COST	Main Span Structure	●●	Upper end of economical span range for this type of structure.	●●	Efficient off-site construction, but added complexity from Delta frames.	●●	Slow construction.	●●	Very efficient span range for this type of structure.	●●●	Inefficient structural system.	●	Efficient and simple structural system, but US record at this span range.	●●●	Not common/not economical for this span range.
	Main Span Foundations	●●		●●		●●		●●		●●		●●	Heavy foundation.	●●	
	Overall	●●		●●		●●		●●		●●		●●	Deeper superstructure requires longer or taller approaches.	●●	
HIGHWAY GEOMETRICS	Grade/Length	●●	Least main span girder depth. Shortest main span creates more flexibility for curved approaches.	●●	Least main span girder depth.	●●	Least main span girder depth.	●	Similar to arches and truss with two cable planes, similar to box girder with single cable plane.	●	Similar to arches and truss with two cable planes, similar to box girder with single cable plane.	●●	Extra approach structure length or grade due to main span girder depth.	●●	Least main span girder depth.
	Footprint	●●		●●		●●		●●		●●		●●		●●	
	Horizontal Tangent Length	●●	Main span only.	●●	Arch and Delta frame spans.	●●	Main and side spans.	●●	Main and side spans.	●●	Main and side span.	●●	Can accommodate moderate plan curvature.	●●	Main and side spans.
MAINSpan FOOTINGS	Vessel Impact	●●		●●		●●		●●		●●		●●		●●	
	Scour	●●		●●		●●		●●		●●		●●		●●	
CONSTRUCTION	Phasing	●●		●●		●●		●●		●●		●●		●●	
	Duration	●●●	Slow construction (stick building)	●●●	Accelerated bridge construction with arch fabricated off-site and floated in.	●●	Significant portion of structure erected by stick building.	●	Accelerated construction by working from two towers simultaneously.	●●	Single work front and linear construction process.	●	Accelerated construction by working from two piers simultaneously, pier segments are time consuming.	●●	Slow construction (cable spinning)
	Constructability	●●	Record-span float-in or stick building, float-in requires fabrication yard on shore between existing bridges due to height of structure.	●●●	Arch floated in, Delta piers simplify lifting operation.	●●	Stick building with floated in drop-in span.	●●	Repetitive construction cycle, but requires careful cable force and geometry control, tower construction.	●	Repetitive construction cycle, but requires careful cable force and geometry control, tower construction.	●	Record span for USA. Repetitive construction cycle.	●●	Uncommon type of structure.
	Impact on Canal Traffic	●●	Reduced channel width (~380 ft) due to falsework required during arch erection (~1 year).	●●	Barge operations near shore line, one 24 hr closure for drop-in lift.	●●	Barge operations near shore line, one 24 hr closure for drop-in lift.	●	Periodic, partial obstructions for segment lift from barge (approximately 40 lifts).	●	Periodic, partial obstructions for segment lift from barge (approximately 40 lifts).	●●●	None.	●	Periodic, partial obstructions for segment lift from barge (approximately 40 lifts).
	Maintenance of Traffic	●●		●●		●●		●●		●●		●●		●●	
Environmental Impact	●●		●●		●●		●●		●●		●●		●●		
STRUCTURAL REDUNDANCY	Fracture-Critical Members	●●	Fracture critical elements (ties, hangers, floorbeams) designed for system or internal redundancy.	●●	Fracture critical elements (ties, hangers, floorbeams) designed for system or internal redundancy.	●●●	Tension diagonals, tension chords designated as fracture-critical members.	●●	Hangers, floorbeams - designed for system or internal redundancy.	●●	Hangers, floorbeams - designed for system or internal redundancy.	●●●	No fracture critical members.	●●	Main cables. Floorbeams and hangers designed for system redundancy.
	Failure-Critical Members	●●	Arch ribs.	●●	Arch ribs.	●●	Any truss member.	●●	Stiffening girder.	●●	Stiffening girder.	●●	Post-tensioning tendons.	●	Saddles.
INSPECTION & MAINTENANCE	Access	●●	Accessible tie girders and ribs, snooper for under-deck, cherry picker for cables.	●●	Accessible tie girders and ribs, snooper for under-deck, cherry picker for cables.	●●	Snooper and cherry picker.	●	Accessible towers, snooper or traveler platform for under-deck, rope access for cables.	●	Accessible towers, snooper or traveler for under-deck, rope access for cables.	●●	Accessible box girder, snooper for under-deck, but cannot inspect internal tendons.	●●	Accessible tower, walkable main cable, snooper or traveler for under-deck.
	Frequency	●	Typical cycle.	●	Typical cycle.	●●	Hands-on inspection of fracture-critical items at two-year intervals.	●	Typical cycle.	●	Typical cycle.	●●●	Typical cycle, fewest inspection items.	●	Typical cycle.
DURABILITY	Protection	●	Has vulnerable elements above deck. Metallized steel, partially prestressed precast deck panels.	●	Has vulnerable elements above deck. Metallized steel, partially prestressed precast deck panels.	●	Has vulnerable elements above deck. Metallized steel, concrete cover and corrosion resistant reinforcement.	●	Has vulnerable elements above deck. Metallized steel, partially prestressed precast deck panels.	●	Has vulnerable elements above deck. Metallized steel, partially prestressed precast deck panels.	●●	Fewest exposed elements, deck fully prestressed longitudinally and transversely, concrete cover and corrosion resistant reinforcement.	●●	Has vulnerable elements above deck. Metallized steel, concrete cover and corrosion resistant reinforcement.
	Replacement	●	Cables, deck overlay system, deck.	●	Cables, deck overlay system, deck.	●	Deck overlay system, deck.	●	Cables, deck overlay system, typically not designed for deck replacement.	●	Cables, deck overlay system, typically not designed for deck replacement.	●●	Deck overlay system, deck replacement not possible.	●●	Cables, deck overlay system. Main cable is not replaceable.
	Monitoring	●	Cables.	●	Cables.	●	None required.	●	Cables.	●	Cables.	●	None required.	●	Cables.
WIND RESPONSE	Structural Efficiency	●		●		●		●		●●	Poor wind performance (effectively twice the span length)	●	Large depth for wind catching area - larger foundation loads.	●	
	Dynamic Effects	●●	Requires wind tunnel studies.	●●	Requires wind tunnel studies.	●	Potential for truss member vibrations.	●●	Requires wind tunnel studies.	●●	Requires wind tunnel studies.	●●	Negligible.	●●	Requires wind tunnel studies.
SNOW & ICE RESPONSE	Bridge closures	●	Uncommon.	●	Uncommon.	●	Uncommon.	●●	During critical climatic conditions.	●●	During critical climatic conditions.	●●	Uncommon.	●●	Uncommon.
	Monitoring/Deicing	●	Ice drop from rib-bracing.	●	Ice drop from rib-bracing.	●	Ice drop from top chord bracing.	●●	Ice drop from cables.	●●	Ice drop from cables.	●●	Uncommon.	●●	Uncommon.
COMMUNITY	Appearance/Signature	●●	Iconic.	●●	Echoes appearance of existing structure.	●●	Utilitarian.	●●	Iconic.	●●	Iconic.	●●	Understated elegance.	●●	Iconic.
	Bike/Pedestrian Path	●●		●●		●●		●●		●●		●●		●●	

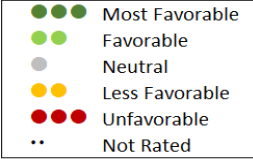
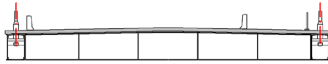




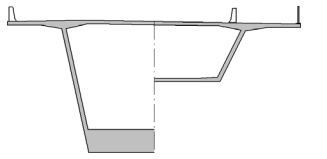


CABLE STAYED BRIDGE TOWERS		Single H		Free-Standing H		Separate H's		Merged H's		Single A/Inverted Y		Separate A's		Merged A's	
															
EVALUATION CRITERIA		Rating	Notes	Rating	Notes	Rating	Notes	Rating	Notes	Rating	Notes	Rating	Notes	Rating	Notes
INITIAL COST	Main Span Structure	●●	Simplest tower shape.	●●	Inefficient structural system.	●	More complex formwork and bracing for inclined legs.	●●	Simple shape, efficient structure.	●	More complex formwork and bracing for inclined legs, inefficient structural system.	●	More complex formwork and bracing for inclined legs.	●	Most complex tower shape.
	Main Span Foundations	●●		●●		●●		●●		●●		●●		●●	
	Overall	●●		●●		●●		●●		●●		●●		●●	
HIGHWAY GEOMETRICS	Grade/Length	●●		●●		●●		●●		●●		●●		●●	
	Footprint	●●		●●		●●		●●		●●		●●		●●	
	Horizontal Tangent Length	●●		●●		●●		●●		●●		●●		●●	
MAINSpan FOOTINGS	Vessel Impact	●●		●●		●●		●●		●●		●●		●●	
	Scour	●●		●●		●●		●●		●●		●●		●●	
CONSTRUCTION	Phasing	●●	Not an option.	●●	Not an option.	●●	Easily accommodates phased construction.	●	Possible, with extra considerations for tower construction.	●●	Not an option.	●●	Easily accommodates phased construction.	●	Possible, with extra considerations for tower construction.
	Duration	●●		●●		●●		●●		●●		●●		●●	
	Constructability	●●	Simplest tower shape.	●		●		●●	Simple tower shape.	●●	Inclined tower legs.	●●	Inclined tower legs.	●●	Inclined and intersecting tower legs.
	Impact on Canal Traffic	●●		●●		●●		●●		●●		●●		●●	
	Maintenance of Traffic	●●		●●		●●		●●		●●		●●		●●	
Environmental Impact	●●	FAA Part 77	●●	FAA Part 77	●●	FAA Part 77	●●	FAA Part 77	●●	FAA Part 77	●●	FAA Part 77	●●	FAA Part 77	
STRUCTURAL REDUNDANCY	Fracture-Critical Members	●●		●●		●●		●●		●●		●●		●●	
	Failure-Critical Members	●●		●●		●●		●●		●●		●●		●●	
INSPECTION & MAINTENANCE	Access	●●		●●		●●		●●		●●		●●		●●	
	Frequency	●●		●●		●●		●●		●●		●●		●●	
DURABILITY	Protection	●●		●●		●●		●●		●●		●●		●●	
	Replacement	●●		●●		●●		●●		●●		●●		●●	
	Monitoring	●●		●●		●●		●●		●●		●●		●●	
WIND RESPONSE	Structural Efficiency	●	Frame action.	●●	Flagpoles.	●	Frame action.	●●	Frame action.	●●	Truss action.	●●	Truss action.	●●	Truss action.
	Dynamic Effects	●●	Good flutter resistance due to great deck width.	●	Flexible tower legs.	●●	Wake effects, upstream/downstream wind flow interactions, poor deck flutter resistance.	●●	Wake effects, upstream/downstream wind flow interactions, poor deck flutter resistance.	●●	Best deck flutter resistance.	●●	Improved deck flutter resistance.	●●	Improved deck flutter resistance.
SNOW & ICE RESPONSE	Bridge closures	●	During critical climatic conditions.	●●	During critical climatic conditions.	●	During critical climatic conditions.	●	During critical climatic conditions.	●●	During critical climatic conditions.	●●	During critical climatic conditions.	●●	During critical climatic conditions.
	Monitoring/Deicing	●	Ice drop from cables.	●●	Ice drop from cables.	●	Ice drop from cables.	●	Ice drop from cables.	●●	Ice drop from cables.	●●	Ice drop from cables.	●●	Ice drop from cables.
COMMUNITY	Appearance/Signature	●●	Simple.	●●	Uneasy.	●	Busy.	●	Simple.	●●	Odd proportions.	●●	Elegant.	●●	Iconic.
	Bike/Pedestrian Path	●●		●●		●●		●●		●●		●●		●●	

CABLE-STAYED BRIDGE PYLONS		Single Cable Plane/Two Boxes		Single Cable Plane/Single Box		Two Cable Planes/Single Box		Three C. Planes/Single Box		Two C. Planes/Edge Girders	
EVALUATION CRITERIA		Rating	Notes	Rating	Notes	Rating	Notes	Rating	Notes	Rating	Notes
INITIAL COST	Main Span Structure	●	Greatest structure weight.	●	Slow deck construction.	●	Slow deck construction.	●	Slow deck construction.	●	Simplest tower.
	Main Span Foundations	**		**		**		**		**	
	Overall	**		**		**		**		**	
HIGHWAY GEOMETRICS	Grade/Length	**		**		**		**		**	
	Footprint	**		**		**		**		**	
	Horizontal Tangent Length	**		**		**		**		**	
MAINSpan FOOTINGS	Vessel Impact	**		**		**		**		**	
	Scour	**		**		**		**		**	
CONSTRUCTION	Phasing	●●	Not an option.	●●	Not an option.	●●	Not an option.	●●	Not an option.	●●	Not an option.
	Duration	**		**		**		**		**	
	Constructability	●	Precast concrete segments for deck.	●●	Cast-in-place concrete for deck.	●●	Cast-in-place concrete for deck.	●●●	Cast-in-place concrete for deck, interaction between three cable planes.	●●	Simplest deck system.
	Impact on Canal Traffic	**		**		**		**		**	
	Maintenance of Traffic	**		**		**		**		**	
	Environmental Impact	**		**		**		**		**	
STRUCTURAL REDUNDANCY	Fracture-Critical Members	**		**		**		**		**	
	Failure-Critical Members	**		**		**		**		**	
INSPECTION & MAINTENANCE	Access	**		**		**		**		**	
	Frequency	**		**		**		**		**	
DURABILITY	Protection	**		**		**		**		**	
	Replacement	**		**		**		**		**	
	Monitoring	**		**		**		**		**	
WIND RESPONSE	Structural Efficiency	●●	Flagpole.	●●	Flagpole.	●●	Tower and deck stabilize each other.	●●	Tower and deck stabilize each other.	●	More flexible deck, small torsional stiffness.
	Dynamic Effects	●	Flexible tower.	●	Flexible tower.	●●	Very stable system.	●●	Very stable system.	●	
SNOW & ICE RESPONSE	Bridge closures	●	During critical climatic conditions.	●	During critical climatic conditions.	●●	During critical climatic conditions.	●●	During critical climatic conditions.	●●	During critical climatic conditions.
	Monitoring/Deicing	●	Ice drop from cables.	●	Ice drop from cables.	●●	Ice drop from cables.	●●	Ice drop from cables.	●●	Ice drop from cables.
COMMUNITY	Appearance/Signature	●●	Clean lines due to single cable plane.	●●	Single cable plane, closed box for deck.	●	Closed box for deck.	●●	Closed box for deck, busy with cables.	●●	Visible deck grillage.
	Bike/Pedestrian Path	**		**		**		**		**	

ARCH RIBS		Single/Vertical Ribs		Separate/Vertical Ribs		Merged/Vertical Ribs		Single/Freestanding		Single/Basket Handle		Separate/Basket Handle	
EVALUATION CRITERIA		Rating	Notes	Rating	Notes	Rating	Notes	Rating	Notes	Rating	Notes	Rating	Notes
INITIAL COST	Main Span Structure	●		●		●		●	Higher rib quantity and complexity, but no upper lateral bracing.	●		●●	Least rib bracing quantity.
	Main Span Foundations	**		**		**		**		**		**	
	Overall	**		**		**		**		**		**	
HIGHWAY GEOMETRICS	Grade/Length	**		**		**		**		**		**	
	Footprint	**		**		**		**		**		**	
	Horizontal Tangent Length	**		**		**		**		**		**	
MAINSPAN FOOTINGS	Vessel Impact	**		**		**		**		**		**	
	Scour	**		**		**		**		**		**	
CONSTRUCTION	Phasing	●●	Not an option.	●●	Easily accommodates phased construction.	●●	Not an option.	●●	Not an option.	●●	Not an option.	●	2x24-ft roadways but no path in temporary configuration.
	Duration	**		**		**		**		**		**	
	Constructability	●●	Fewer, larger pieces to handle.	●●	Smaller, but more pieces to handle.	●●●	Three cable planes makes hangerforces and floorbam moments difficult to control.	●●	Demanding geometry control for ribs.	●	More complex rib shoring.	●●	Smaller pieces to handle.
	Impact on Canal Traffic	**		**		**		**		**		**	
	Maintenance of Traffic	**		**		**		**		**		**	
	Environmental Impact	**		**		**		**		**		**	
STRUCTURAL REDUNDANCY	Fracture-Critical Members	**		**		**		**		**		**	
	Failure-Critical Members	**		**		**		**		**		**	
INSPECTION & MAINTENANCE	Access	**		**		**		**		**		**	
	Frequency	**		**		**		**		**		**	
DURABILITY	Protection	**		**		**		**		**		**	
	Replacement	**		**		**		**		**		**	
	Monitoring	**		**		**		**		**		**	
WIND RESPONSE	Structural Efficiency	●	Truss action, but high moment demans at portal frame.	●	Truss action, but high moment demans at portal frame.	●	Truss action, but high moment demans at portal frame.	●●●	Structural system not appropriate for this site.	●●	A-shape helps with wind resistance.	●●	A-shape helps with wind resistance.
	Dynamic Effects	●	More susceptible	●●	Wake galloping of cables.	●	More susceptible.	●●	Most susceptible.	●●	Less susceptible.	●●	Less susceptible.
SNOW & ICE RESPONSE	Bridge closures	●	Uncommon.	●	Uncommon.	●	Uncommon.	●	Uncommon	●	Uncommon.	●	Uncommon.
	Monitoring/Deicing	●	Ice drop from rib bracing.	●	Ice drop from rib bracing.	●	Ice drop from rib bracing.	●●	No bracing members.	●●	Ice drop from ribs and rib bracing.	●●	Ice drop from ribs and rib bracing.
COMMUNITY	Appearance/Signature	●●	More rib bracing.	●●	More rib bracing.	●●	More rib bracing.	●●	Clean lines.	●●	Odd proportions.	●●	Less bracing.
	Bike/Pedestrian Path	**		**		**		**		**		**	

BOX GIRDERS		Single Concrete Box		Separate Concrete Boxes		Separate Steel Boxes	
EVALUATION CRITERIA		Rating	Notes	Rating	Notes	Rating	Notes
INITIAL COST	Main Span Structure	●●●	Very complex and heavy form traveler.	●●	Good repetition and rhythm.	●●●	Not competitive due to complex fabrication.
	Main Span Foundations	**		**		**	
	Overall	**		**		**	
HIGHWAY GEOMETRICS	Grade/Length	**		**		**	
	Footprint	**		**		**	
	Horizontal Tangent Length	**		**		**	
MAINSpan FOOTINGS	Vessel Impact	**		**		**	
	Scour	**		**		**	
CONSTRUCTION	Phasing	●●	Not an option.	●●	Easily accommodates phased construction.	●●	Easily accommodates phased construction.
	Duration	**		**		**	
	Constructability	●●	Complex and heavy form traveler.	●●	Routine.	●●	Unusual system.
	Impact on Canal Traffic	**		**		**	
	Maintenance of Traffic	**		**		**	
	Environmental Impact	**		**		**	
STRUCTURAL REDUNDANCY	Fracture-Critical Members	●●	No.	●●	No.	●●	Tension flanges and webs.
	Failure-Critical Members	**		**		**	
INSPECTION & MAINTENANCE	Access	**		**		**	
	Frequency	**		**		**	
DURABILITY	Protection	**		**		**	
	Replacement	**		**		**	
	Monitoring	**		**		**	
WIND RESPONSE	Structural Efficiency	**		**		**	
	Dynamic Effects	●	Insensitive to dynamic effects.	●	Insensitive to dynamic effects.	●●	Sensitive to vortex-shedding induced oscillations.
SNOW & ICE RESPONSE	Bridge closures	**		**		**	
	Monitoring/Deicing	**		**		**	
COMMUNITY	Tensioned	●●	Understated elegance, closed box gives clean lines.	●●	Understated elegance, closed box gives clean lines.	●	Splices detract from otherwise elegant appearance.
	Bike/Pedestrian Path	**		**		**	

DECK GIRDERS		Edge Steel Box (Arch)		Edge I-Girder W/Bracket (C.S.)		Edge I-Girder W/Fin (C.S.)		Edge Concrete Girders (C.S.)		Cable-Supported Box Girder		Self-Supporting Box Girder	
													
EVALUATION CRITERIA		Rating	Notes	Rating	Notes	Rating	Notes	Rating	Notes	Rating	Notes	Rating	Notes
INITIAL COST	Main Span Structure	**		**		**		**		**		**	
	Main Span Foundations	**		**		**		**		**		**	
	Overall	**		**		**		**		**		**	
HIGHWAY GEOMETRICS	Grade/Length	**		**		**		**		**		**	
	Footprint	**		**		**		**		**		**	
	Horizontal Tangent Length	**		**		**		**		**		**	
MAINSpan FOOTINGS	Vessel Impact	**		**		**		**		**		**	
	Scour	**		**		**		**		**		**	
CONSTRUCTION	Phasing	**		**		**		**		**		**	
	Duration	**		**		**		**		**		**	
	Constructability	●●	Simple system, much repetition.	●●	Simple system, much repetition.	●	Simple system, much repetition, but fin plate connection to edge girder is challenging.	●●	Precast or cast-in-place deck, difficult erection control.	●	Numerous heavy precast elements.	●●	Simplest system.
	Impact on Canal Traffic	**		**		**		**		**		**	
	Maintenance of Traffic	**		**		**		**		**		**	
	Environmental Impact	**		**		**		**		**		**	
STRUCTURAL REDUNDANCY	Fracture-Critical Members	●●	Edge boxes designed for internal redundancy.	●●	Floorbeam spacing < 12 feet or > 15 feet with redundancy girders.	●●	Floorbeam spacing < 12 feet or additional redundancy girders.	●●	None.	●●	None.	●●	None.
	Failure-Critical Members	●		●		●		●	Floorbeam post-tensioning tendons.	●●	Delta frames are critical component of system.	●	Longitudinal post-tensioning tendons.
INSPECTION & MAINTENANCE	Access	●●	Accessible edge box girder, snooper.	●●	Snooper or inspection traveler.	●●	Snooper or inspection traveler.	●●	Snooper or inspection traveler.	●●	Accessible box girders, snooper.	●●	Accessible box girders, snooper.
	Frequency	**		**		**		**		**		**	
DURABILITY	Protection	●●	Cable anchorages inside box.	●	Cable anchorages below deck level.	●●	Cable anchorages at deck level.	●●	Cable anchorages underneath edge girders.	●●	Cable anchorages and Delta frames below deck.	●●	Very few exposed elements.
	Replacement	**		**		**		**		**		**	
	Monitoring	**		**		**		**		**		**	
WIND RESPONSE	Structural Efficiency	**		**		**		**		**		**	
	Dynamic Effects	**		**		**		**		**		**	
SNOW & ICE RESPONSE	Bridge closures	**		**		**		**		**		**	
	Monitoring/Deicing	**		**		**		**		**		**	
COMMUNITY	Appearance/Signature	●	Visible deck grillage and bracing, numerous splices.	●	Visible deck grillage, numerous splices.	●	Visible deck grillage.	●●	Cleaner lines, no splices.	●●	Closed box, cleaner lines.	●●	Closed box, cleaner lines.
	Bike/Pedestrian Path	**		**		**		**		**		**	

APPROACHES		Steel Plate Girders		Concrete Bulb Tees		Single-Cell Concrete Box		Steel Tub Girders	
EVALUATION CRITERIA		Rating	Notes	Rating	Notes	Rating	Notes	Rating	Notes
INITIAL COST	Main Span Structure	●●●	Common bridge type, longer spans available.	●●	Less efficient system, shorter spans (125-ft).	●	Only economical in conjunction with segmental main box	●●	More complex fabrication, but cost competitive for straight highway alignment.
	Main Span Foundations	●●		●●	More foundations.	●	Heavy foundations.	●●	
	Overall	●●		●●		●●		●●	
HIGHWAY GEOMETRICS	Grade/Length	●●		●●		●●		●●	
	Footprint	●●		●●		●●		●●	
	Horizontal Tangent Length	●●		●●		●●		●●	
MAINSpan FOOTINGS	Vessel Impact	●●		●●		●●		●●	
	Scour	●●		●●		●●		●●	
CONSTRUCTION	Phasing	●●	Can be easily accommodated.	●●	Can be easily accommodated.	●●	With two boxes.	●●	Can be easily accommodated.
	Duration	●●		●●		●●		●●	
	Constructability	●●	Typical system.	●	Typical system, transportation becomes limiting factor.	●●	Requires complex erection gantry or falsework.	●●	Typical system.
	Impact on Canal Traffic	●●		●●		●●		●●	
	Maintenance of Traffic	●●		●●		●●		●●	
	Environmental Impact	●●		●●		●●		●●	
STRUCTURAL REDUNDANCY	Fracture-Critical Members	●●		●●		●●		●●	
	Failure-Critical Members	●●		●●		●●		●●	
INSPECTION & MAINTENANCE	Access	●●		●●		●●		●●	
	Frequency	●●		●●		●●		●●	
DURABILITY	Protection	●●	Weathering steel, deck protection system.	●●	Fully prestressed girders, deck protection system.	●●	Deck prestressed in two directions, deck protection system.	●●	Weathering steel, deck protection system.
	Replacement	●●	Deck is replaceable.	●●	Deck is replaceable.	●	Sacrificial deck thickness, deck not replaceable.	●●	Deck is replaceable.
	Monitoring	●●		●●		●●		●●	
WIND RESPONSE	Structural Efficiency	●●		●●		●●		●●	
	Dynamic Effects	●●		●●		●●		●●	
SNOW & ICE RESPONSE	Bridge closures	●●		●●		●●		●●	
	Monitoring/Deicing	●●		●●		●●		●●	
COMMUNITY	Appearance/Signature	●	Utilitarian.	●	Utilitarian.	●●	Clean lines.	●●	Clean lines.
	Bike/Pedestrian Path	●●		●●		●●		●●	

## APPENDIX B – MASSING STUDIES OF PROPOSED BRIDGE TYPES AND CONFIGURATIONS

The renderings show preliminary and conceptual geometry and proportions of bridge alternatives proposed for further evaluation. Further refinement and revisions will take place as the type studies progress.

# PRE-DECISIONAL & DELIBERATIVE



CS1 - CABLE-STAYED  
SINGLE BRIDGE - 820' SPAN  
H-TOWERS



# PRE-DECISIONAL & DELIBERATIVE



CS2 - CABLE-STAYED  
SINGLE BRIDGE - 820' SPAN  
V-TOWERS

# PRE-DECISIONAL & DELIBERATIVE



CS3 - CABLE-STAYED  
SINGLE BRIDGE - 820' SPAN  
A-TOWERS

# PRE-DECISIONAL & DELIBERATIVE



CS4 - CABLE-STAYED  
SINGLE BRIDGE - 820' SPAN  
Y-TOWERS

# PRE-DECISIONAL & DELIBERATIVE



CS5 - CABLE-STAYED  
SINGLE BRIDGE - 820' SPAN  
PYLONS

# PRE-DECISIONAL & DELIBERATIVE



CS6 - CABLE-STAYED  
TWIN BRIDGES - 700' SPAN  
H-TOWERS

# PRE-DECISIONAL & DELIBERATIVE



CS7 - CABLE-STAYED  
TWIN BRIDGES - 700' SPAN  
A-TOWERS

# PRE-DECISIONAL & DELIBERATIVE



CS8 - CABLE-STAYED  
TWIN BRIDGES - 700' SPAN  
MERGED A-TOWERS

# PRE-DECISIONAL & DELIBERATIVE



CS9 - CABLE-STAYED  
TWIN BRIDGES - 820' SPAN  
H-TOWERS



# PRE-DECISIONAL & DELIBERATIVE



CS10 - CABLE-STAYED  
TWIN BRIDGES - 820' SPAN  
A-TOWERS

# PRE-DECISIONAL & DELIBERATIVE



CS11 - CABLE-STAYED  
TWIN BRIDGES - 820' SPAN  
MERGED A-TOWERS

# PRE-DECISIONAL & DELIBERATIVE



BG1 - POST - TENSIONED BOX GIRDER  
TWIN BRIDGES - 734' SPAN  
VARIABLE SOFFIT

# PRE-DECISIONAL & DELIBERATIVE



TA1 - TIED ARCH  
TWIN BRIDGES - 700' SPAN  
BASKET HANDLE RIBS

# PRE-DECISIONAL & DELIBERATIVE



TA2 - TIED ARCH WITH DELTA FRAME  
SINGLE BRIDGE - 700' SPAN  
VERTICAL RIBS

# PRE-DECISIONAL & DELIBERATIVE



TA3 - TIED ARCH WITH DELTA FRAME  
TWIN BRIDGES - 700' SPAN  
VERTICAL RIBS

# PRE-DECISIONAL & DELIBERATIVE



TA4 - TIED ARCH WITH DELTA FRAME  
TWIN BRIDGES - 700' SPAN  
BASKET HANDLE RIBS

# PRE-DECISIONAL & DELIBERATIVE



TA5 - TIED ARCH WITH DELTA FRAME  
TWIN BRIDGES - 820' SPAN  
VERTICAL RIBS



# PRE-DECISIONAL & DELIBERATIVE



TA6 - TIED ARCH WITH DELTA FRAME  
TWIN BRIDGES - 820' SPAN  
BASKET HANDLE RIBS

# Appendix B Cape Cod Bridge Replacements Constructability Assessment



CAPE COD BRIDGE REPLACEMENTS

# Constructability Assessment

PREPARED BY

**HNTB**

FOR

**massDOT**  
Massachusetts Department of Transportation

2021

## Cape Cod Bridges – Constructability Assessment

### TABLE OF CONTENTS

1	Introduction .....	1
2	Representative Configurations .....	1
3	Site Conditions .....	2
3.1	Location and Access .....	2
3.2	Canal.....	2
3.3	Shore .....	3
3.4	Wind.....	3
4	Foundations .....	3
4.1	Layout and Service Road Impacts .....	3
4.2	Deep Foundations .....	4
4.3	Footing Construction .....	4
5	Arch Construction .....	4
5.1	In-Situ Erection.....	4
5.2	Float-in Erection.....	5
6	Cable Stay Construction .....	9
7	Demolition .....	10
7.1	Existing Bridges .....	10
7.2	Methodology.....	11
8	Constructability Takeaways .....	12
8.1	Risks .....	12
8.2	Recommendations .....	12

Appendix A – Fabrication Site Screening

Appendix B – Site Visit Memo

### 1 INTRODUCTION

The existing Cape Cod Bridges have reached the end of their useful economic life and need replacement. In an initial screening study, documented in a separate report, a large number of bridge design parameters and bridge types were evaluated systematically in order to arrive at a selection of feasible and favorable options for replacement bridges. The initial selection included cable-stayed, haunched concrete box girder, and tied arch bridges. As part of a second phase of screening, the initially recommended alternatives were tested against highway design constraints which disfavored the haunched concrete box girder type. The remaining feasible alternatives were then evaluated in greater depth for constructability, as documented in the present report.

### 2 REPRESENTATIVE CONFIGURATIONS

To focus the scope of the constructability review, several configurations were identified which collectively represent the range of parameters across the feasible alternatives.

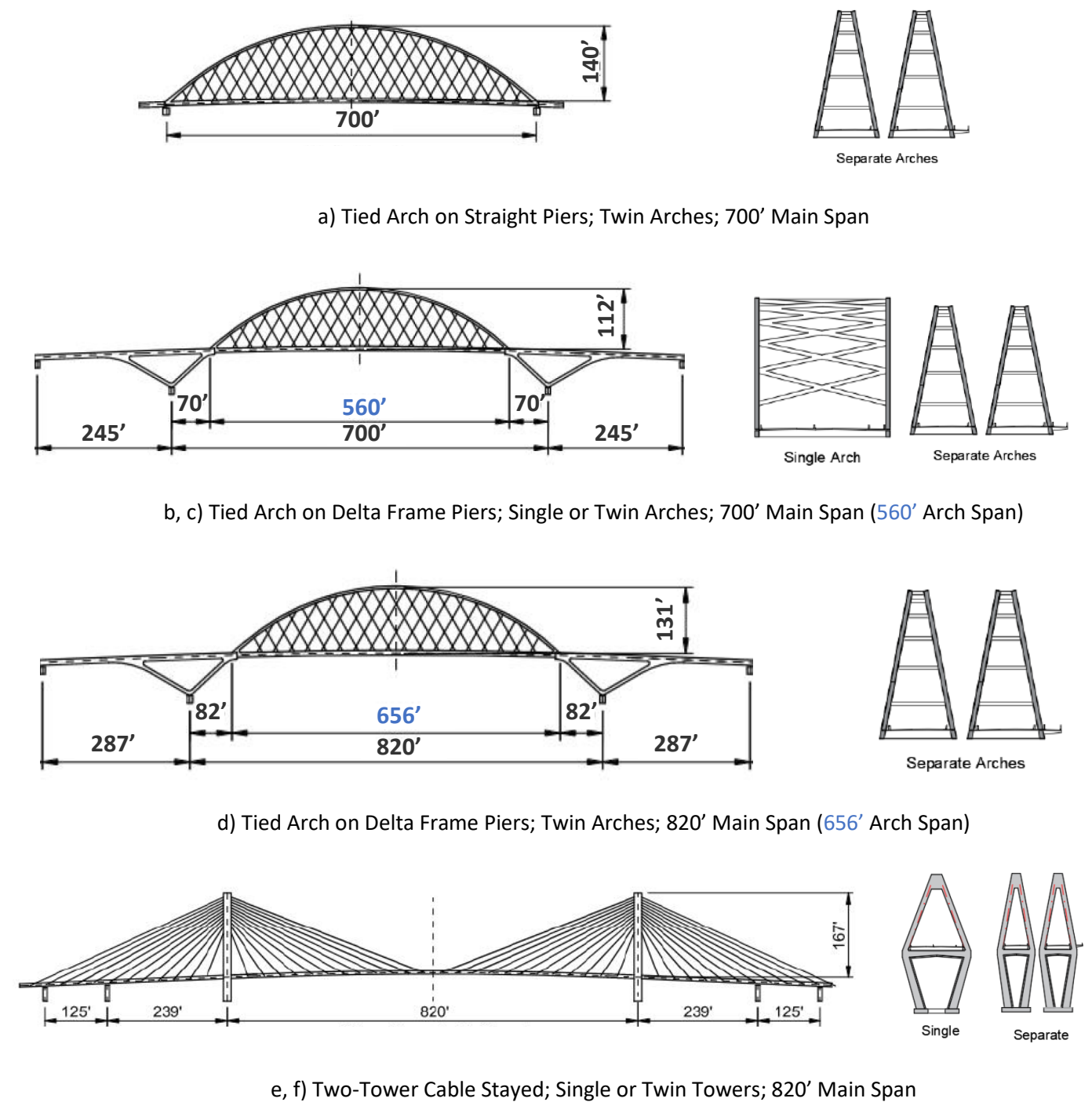


Fig. 2.1 – Representative configurations for constructability evaluation

This report evaluates the six configurations shown in Figure 2.1 for various aspects of constructability, including: fabrication, material transport, erection methodology, and impacts to canal and canal-side traffic. Additional discussion of site conditions and demolition approach is also included. For the purposes of this evaluation, no distinction was made between the Sagamore and Bourne bridges; the analysis presented here at this level of conceptual design applies to both except for specific site conditions as noted.

For the tied arch options, there are two configurations. The traditional system uses vertical piers with the arches supported on top of these piers (Figure 2.1a). Alternatively, with the delta-frame arrangement the approach spans cantilever into the main span, thus shortening the length of the actual tied arch, albeit at the expense of a more complex approach span structure (Figures 2.1b-d).

### 3 SITE CONDITIONS

#### 3.1 Location and Access

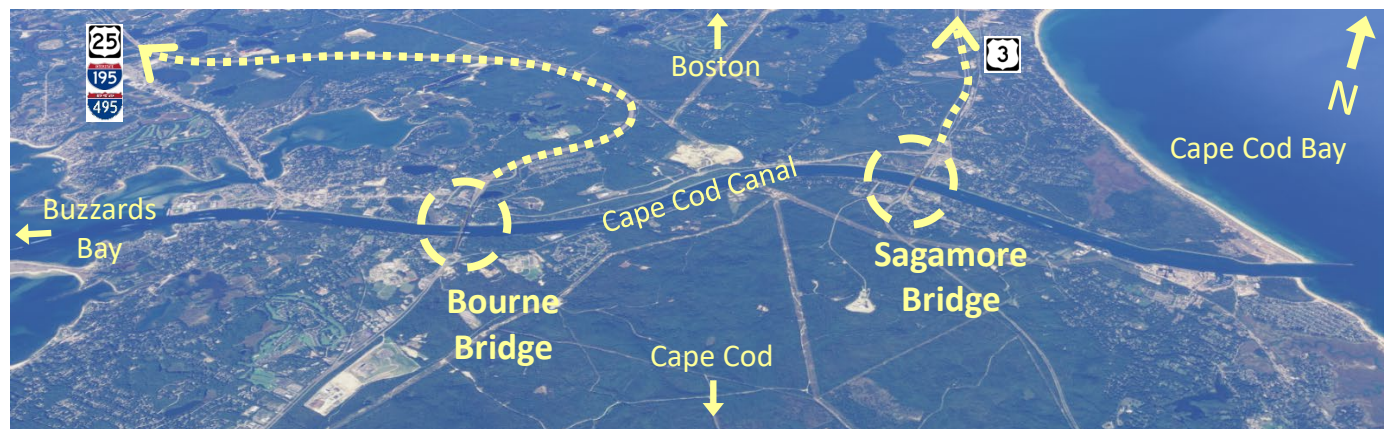


Fig. 3.1 – Site location

The Cape Cod Bridges span the Cape Cod Canal which connects Cape Cod Bay on the east with Buzzards Bay on the west. Both crossings service state routes with accessible connections to Interstates I-195 and I-495. The approaches on each shore are connected by service roads: Route 6 on the north, and Sandwich Road on the south. Existing approach ramps and local roads can accommodate typical truck traffic for material deliveries. Over-length permit vehicles may be restricted from specific movements due to tight radius and/or grade changes, however the combination of twin spans and service roads generally provides an alternate movement which is less restrictive.

The Bourne and Sagamore bridges provide the only vehicular access from mainland Massachusetts to Cape Cod. The crossings are utilized by nearly 215,000 year-round residents, as well as a 300% population increase at the peak of summer tourism between Memorial Day and Labor Day. Traffic during the summer months can be severe including multi-hour backups, and any lane closures or work zone restrictions will exacerbate conditions. Concrete deliveries to site will need to account for potentially significant traffic delays.

#### 3.2 Canal

The Cape Cod Canal is a seven-mile-long artificial waterway originally constructed in 1914 and maintained and operated by the US Army Corps of Engineers (USACE). The canal navigational channel is 480' wide with a nominal draft depth of 32' at mean low water maintained by regular dredging. The canal features a strong 6-knot tidal current which reverses direction every 6 hours with only 15 minutes of slack tide in-between (see Figure 3.2). The

canal is utilized year-round by over 21,000 recreational and commercial vessels, of which over a quarter were ships of more than 65' in length carrying almost 7 million tons of cargo. There are three spans crossing the canal: the Bourne and Sagamore vehicular bridges, and the Cape Cod Canal Railroad Bridge at the west end. All three existing bridges maintain 135' of vertical clearance at MHW (mean high water). Design criteria for the new bridges will require maintaining the existing horizontal and vertical clearances, as well as accommodating future sea rise.

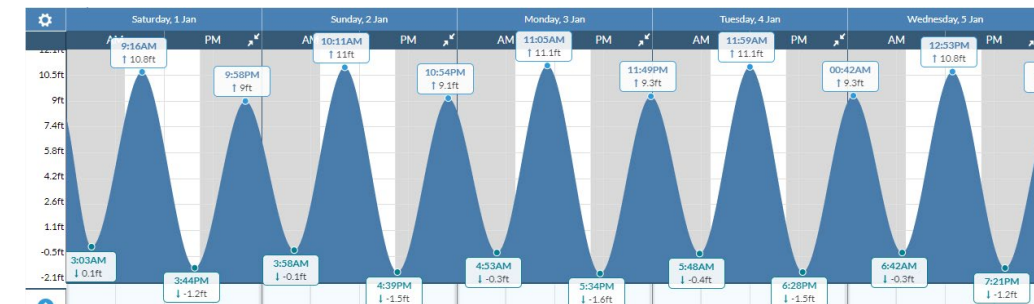


Fig. 3.2 – Sample tide chart for Cape Cod Canal

Canal traffic operates in both directions. Reductions in navigable width due to construction activities may require the canal to institute alternate one-way operation at the construction sites. USACE prefers short-term canal closures over long-term operational restrictions in the channel. Traffic conditions on the canal present a risk of impact to any in-water equipment or falsework within or adjacent to the navigable channel. Long-term obstruction of the canal will amplify this risk.

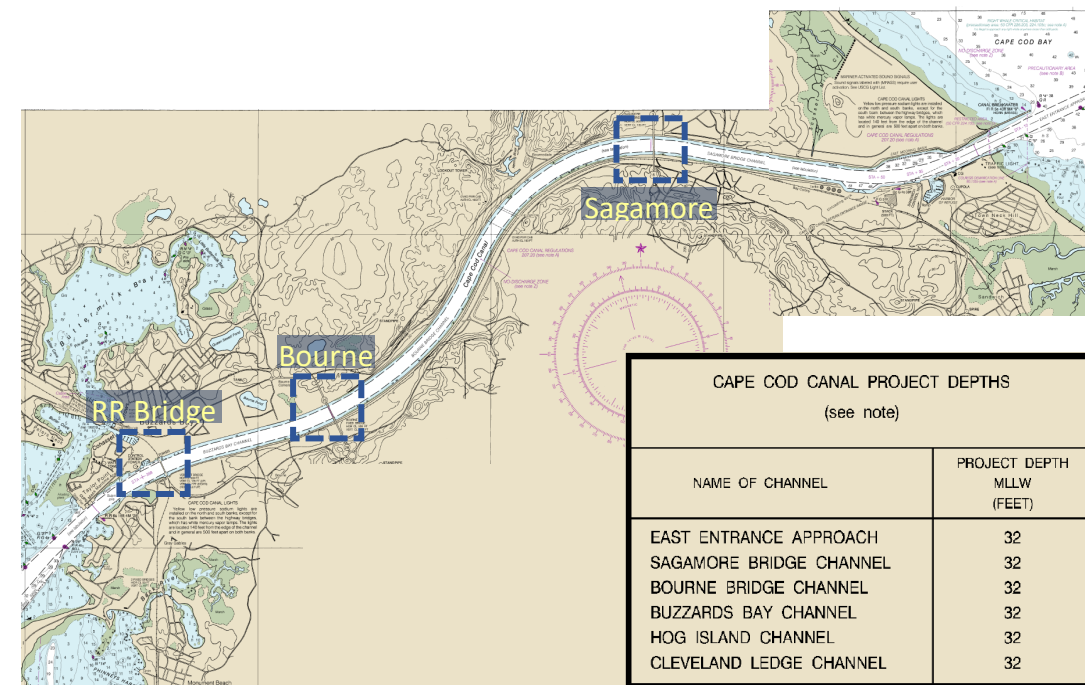


Fig. 3.3 – NOAA soundings chart for Cape Cod Canal

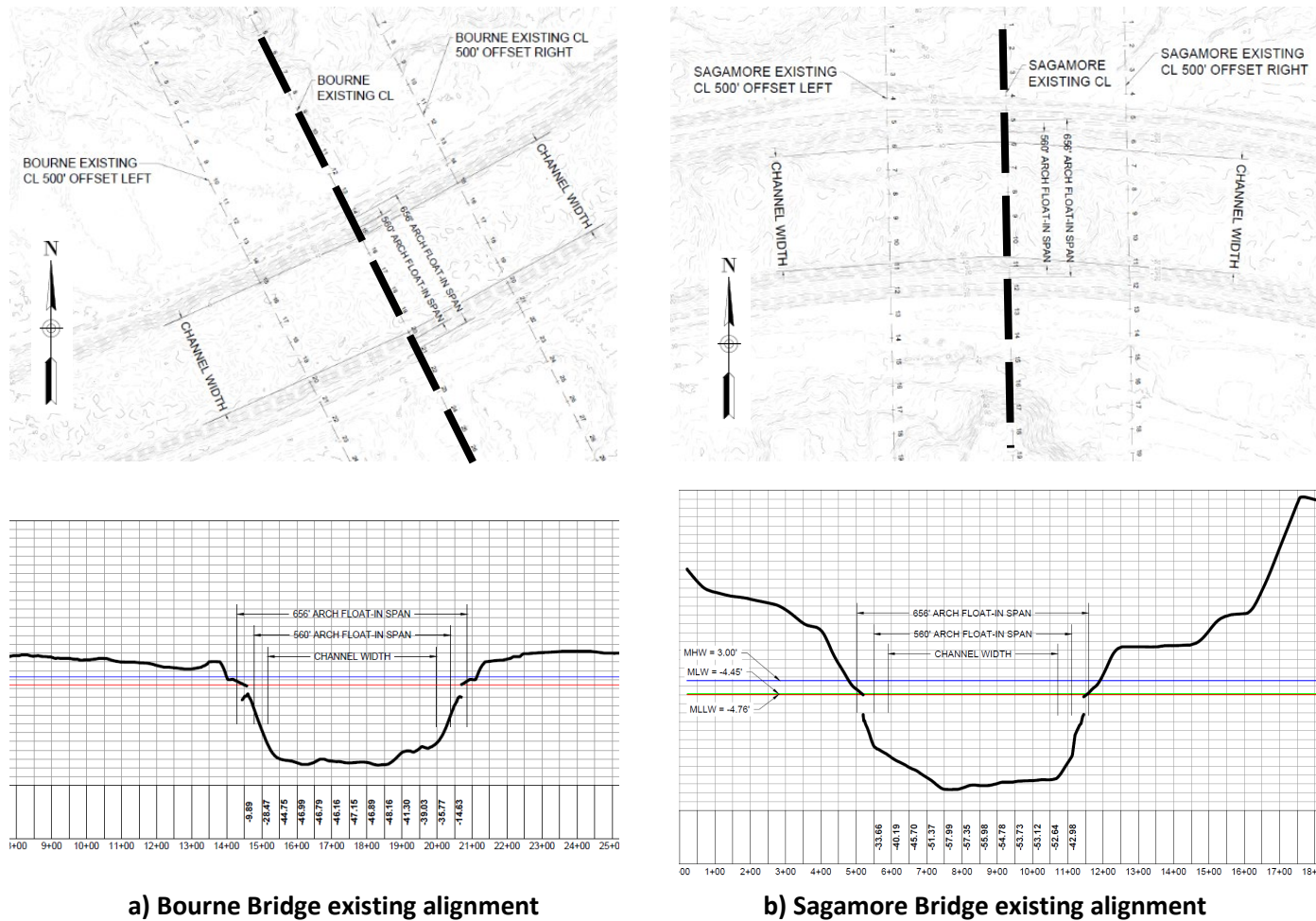


Fig. 3.4 – Canal Bathymetry

3.3 Shore

Both shores of the canal feature significant residential and commercial utilization, with remaining undeveloped parcels held as preserve land by a combination of state parks, conservation trusts, and federal agencies. USACE holds a right-of-way full length of the canal and maintains service roads on both sides of the canal to facilitate riprap maintenance. The service roads are open to public access and there is significant use by local residents and visitors for walking, running, fishing, and biking. Multiple canal access points have been developed into recreation areas, including one at each existing bridge, and there is a campground east of the Bourne bridge.



Fig. 3.5 – Mass Coastal Railroad

Topographically, the north bank features a significant bluff which rises just past the service road. On the south bank, the Mass Coastal Railroad runs full length of the canal from the Cape Cod Railroad Bridge on the west end to the Sandwich Marina on the east end. The railroad operates daily refuse trains on the tracks and passenger rail service on the weekends, including service to the Bourne station located at the Bourne Recreational Area below the bridge.

The shoreline of the canal is protected by roughly 50' of riprap outside the navigation channel. There are no existing bulkhead or mooring facilities along the canal in the vicinity of the bridges. It will be challenging for a land-based crawler crane to reach across this region to receive material deliveries via water without modifying the shore to facilitate access (e.g. finger piers or dredging).

At the existing Bourne bridge, there is a drainage outfall on the north shore. It is anticipated this outfall will require reconstruction or relocation as part of the revised drainage scheme.



Fig. 3.6 – Existing drainage outfall and riprap

3.4 Wind

The siting of the Canal between Cape Cod Bay and Buzzards Bay combines with the topography to generate significant wind conditions at the project site. Cape Cod is subject to significant coastal storms including hurricanes (e.g. Henri in Aug 2021) and Nor'easters (typically 2-5 per winter). To mitigate the risk associated with extreme weather or wind events, a design and erection strategy which minimizes the time the structure is vulnerable during erection is preferred.

Over the past decade, sustained wind speeds of 20mph or greater have been recorded on approximately 10% of days during the winter months (October through April). Gusts exceeding 40mph occur regularly. These wind conditions may present a challenge for the use of tall cranes—whether ground, barge, or tower based. These cranes generally have a safe operational wind ceiling of 25mph, implying frequent loss of use would be expected at this site. A site-specific meteorological study is strongly recommended to establish wind parameters for both permanent design and construction loading at bridge height.

Wind interaction between adjacent structures is also a consideration, either between a new structure and the existing bridge, or between two new twin structures. Vortex shedding and other aeroelastic effects should be carefully evaluated for both the permanent condition and for all intermediate stages of construction.

4 FOUNDATIONS

4.1 Layout and Service Road Impacts

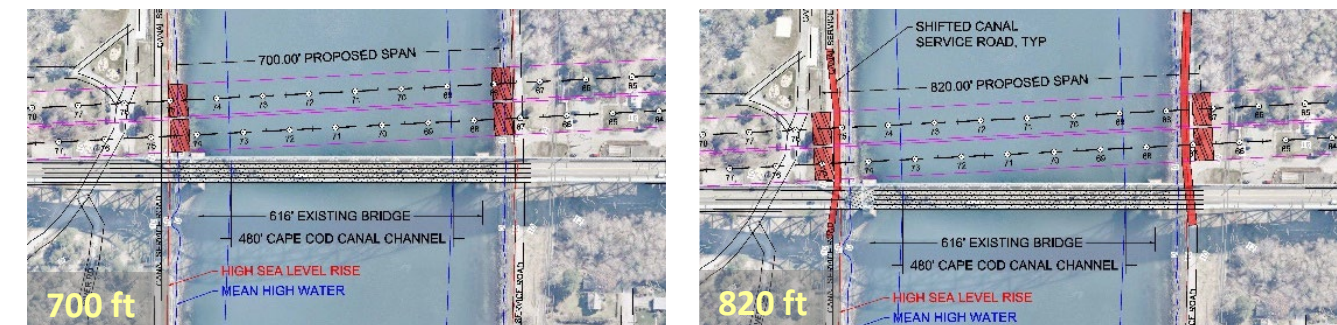


Fig. 4.1 – Footing Layout for 700' and 820' Spans

The initial selection process identified 700' and 820' span lengths as preferred for footing placement as these layouts do not impact navigational clearance of the canal. A 700' span places footings at the waterline adjacent to the service road. The longer 820' span extends the footings outward and requires shifting the service road to fall

between the new footings and the waterline. Construction will require temporary closure of public access to the existing canal service roads along each bank. Access will be maintained for USACE to perform riprap and lighting maintenance.

#### 4.2 Deep Foundations

The new crossings will require deep foundations. Information from the area’s Geology, visual record of the Cape Cod Canal’s construction, and the 1934 USCOE plans of the existing Cape Cod bridges, show the probable existence of very large boulders at various locations and different depths at the site.

Consequently, a Pilot Geophysical Survey was conducted at the existing bridges’ canal-piers and abutments to uncover the subsurface soil and bedrock profile, and to detect and locate possible boulders and boulder layers that could impact the construction of the new bridge’s sub-structures. The Geophysical exploration, using Ground Penetrating Radar (GPR), determined that Boulders are present in the subsurface at depths of 2 to 35 feet below ground surface and that Boulder layers could be present at depths greater than 35 feet. The exploration concluded that the depth of competent bedrock varies between 87 and 196 feet below ground surface. The overburden is composed of surficial fill above thick layer of Sand and Gravel.

The next phase consists of conducting a Pilot Subsurface Exploration program with the intent to gain a more detailed outline of the underground elements (such as soils type / profile, groundwater levels, bedrock’s type / condition) as well as to confirm the existence, location, depth, and configuration of boulders as detected by the Geophysical Survey. This information is critical for the conceptual design of the foundation, as boulders would be an obstacle to the installation of cofferdams and deep foundation. While Drilled Shafts and drilled Micro Piles can be installed through boulders with special tools, boulders are an impediment to Driven Piles unless an extensive pre-drilling system is used.

Later, at the Sketch Plan phase, there will be a more typical full boring program once final locations of structures and roadways have been determined. Also, MassDOT Geotechnical had suggested to initiate, during the pre-construction phase, a “Pilot Load-testing Program” to check applicable type and length of driven piles, thus providing data for Contractors, mitigating potential extra-work orders, and saving both schedule and cost for the final project.

#### 4.3 Footing Construction

Based on the water table and preliminary stratigraphy, a perched footing on land is not viable. As such, a cofferdam will be required for footing construction regardless of whether the footing is located on land or at the shore. Due to the existing riprap along both banks of the canal, minimal environmental impacts are anticipated in the benthic zone.

### 5 ARCH CONSTRUCTION

The initial screening study identified arches, and specifically tied-arch spans, as well suited to the site conditions at Bourne and Sagamore. As such, they are well represented in this report with tied arches comprising four of six concepts evaluated. Tied-arch bridges are generally constructed via one of two methodologies: in-situ piecewise erection utilizing temporary supports, or off-site fabrication of a complete arch span followed by transport and heavy lifting to install the structure in the permanent location. The following parameters are evaluated for both scenarios:

- **Navigational impacts:** Short and long-term impacts to canal operations due to temporary supports or equipment (e.g. crane barges) located in the navigable waterway. Also consider closures required for transport and lifting operations.
- **Crane requirements:** Crane reach, lifting capacity, and placement.
- **Arch aspect ratio:** Design considerations of limited arch height to span length ratio (typically 1:5 to 1:6). Arch efficiency decreases with height-to-span ratio, constraining arch rise adds cost and complexity to the design.
- **Arch rib orientation:** Vertical versus inclined (see initial screening study for additional discussion).
- **Structure width:** Floorbeam pick weight, geometry control, and transport considerations. Single versus twin structures.

Additionally, several parameters specific to off-site fabrication are considered:

- **Fabrication site:** Suitability of various local, regional, and national locations for arch fabrication.
- **Clearance envelope:** Bounding box for transport to verify vertical and horizontal navigational clearances.
- **Lifting weight:** Steel only erection weight for heavy lifting activities.

#### 5.1 In-Situ Erection

In-situ piecewise erection, referred to as ‘stick building’, is a traditional methodology for arch construction which relies on falsework to temporarily support arch members until the full span is complete. Historically, stick building has been the primary method used for steel deck and truss arches, and is still the preferred strategy for erecting tied arches with span and width configurations not amenable to a float-in approach. Falsework can be implemented as temporary piers supporting the arch tie from below, or as high towers with cable stays supporting the arch rib from above.



a) Temporary Piers

b) Cable Stay Towers

Fig. 5.1 – Two schemes for temporary support during arch erection

Temporary piers are typically located at quarter-span points to support temporary struts holding the arch ribs, which would reduce navigational clearance from 480’ to 410’ for an 820’ span. These piers and struts are required for a significant portion of arch span erection, and as such, would represent a long-term impact to navigational clearance. Spacing of temporary piers can reasonably be increased to maintain the existing 480’ navigational clearance, however this increases the strut angle and may result in uplift requiring hold-downs during erection. It is important

to recognize that the risk of vessel impact remains if temporary piers are just outside the navigation channel. Temporary fendering or other means of pier protection would introduce significant expense and complexity.

Cable-stayed high tower falsework utilizes tall temporary towers located at each end of the span to support the arch rib and, via hangers, the arch tie segments below. Towers are typically restrained with adjustable guys which counterbalance the increasing weight of the arch during erection. High towers have the advantage of eliminating the need for temporary piers in the channel but at the tradeoff of increased wind exposure, adding design cost and complexity and increasing risk throughout the duration of arch erection. Vertical arch ribs are strongly preferred with a high tower erection scheme as inclined 'basket-handle' ribs result in challenging cable geometry.

For all stick-building schemes, single full-width arches will be more challenging to erect than twin independent structures: a single arch will require large floorbeams with considerable pick weights and in general it will be more challenging to control geometry on the larger structure. Both single and twin structures will require very large cranes or dual crane picks due to the required boom extension to set upper arch segments. High winds may restrict operation of tall cranes. Crane and service barges will present an ongoing navigation obstruction and impact risk throughout the duration of arch erection.

## 5.2 Float-in Erection

An alternate approach to in-situ construction is to fabricate the arch span offline of the permanent alignment, then transport it to the final installed position. Where site conditions permit arch construction adjacent to the final alignment, transport may be achieved by launching on rollers or via self-propelled modular transports (SPMTs), however most offsite construction strategies for water crossings require at least a short-distance transport over water via barge.

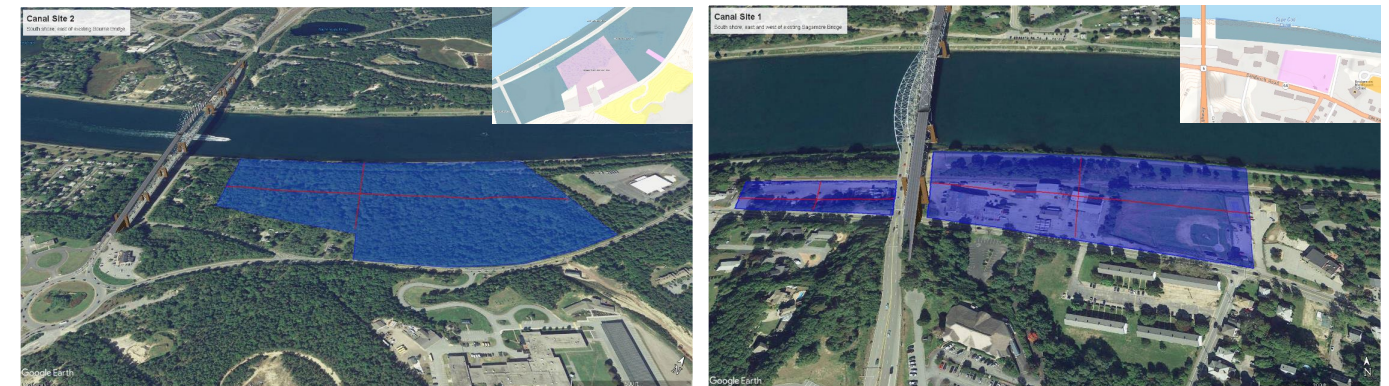
Tied arches are well suited to float-in strategies as the arch is self-supporting and stable for transport once assembled. To minimize transport and lifting weight, arches are transported as steel-only with a precast or cast-in-place concrete deck placed after the arch is installed. Arches can be constructed directly on a moored barge or constructed on land and transferred to a barge via SPMT for transport. Loading or constructing an arch on a barge requires a suitable slip or bulkhead with sufficient length, draft, and load capacity to support heavy equipment. Temporary mooring facilities can be constructed if no suitable facilities exist, however the cost and environmental impacts of in-water construction required to construct a temporary mooring facility should be carefully considered when evaluating a site.

### 5.2.1 Fabrication Sites

In assessing potential arch fabrication sites, the first locations evaluated are those directly adjacent to the proposed bridge alignment. These locations do not require complex open-water transport and offer the benefit of concentrating work activities local to each structure. An evaluation of various strategies for fabrication local to the sites found the following:

- A longitudinal construction and launch strategy along or parallel to the existing alignment is precluded or cost prohibitive due to site topography.
- Construction adjacent to each alignment is constrained by topography on the north shore. Two potential fabrication areas were explored on the south shore (see Figure 5.2), but they were found to be impractical due to extensive residential and commercial development and extensive conservation land. Additionally, the Mass Coastal Railroad track runs parallel to the south shore approximately 100' inland, which would bisect any likely work sites presenting logistical and safety challenges.

- Construction on the canal shore adjacent to the alignment requires a bulkhead or other mooring facility which does not currently exist along the canal. The canal bathymetry features a shallow zone along the shore lined with riprap. Mooring facilities would require either dredging or extension of a pier into the canal to provide sufficient draft for barge operations. Construction of these facilities at Borne and Sagamore would be costly, create a long-term reduction in navigational width for the canal, and is not recommended within the environmentally sensitive region of the canal and shoreline.



a) Bourne Bridge Area

b) Sagamore Bridge Area

Fig. 5.2 – Potential local fabrication sites along canal

With no viable candidates for fabrication sites found along the canal, we next explore regional opportunities along the Massachusetts coastline and connected waterways. Regional sites will require transport of the assembled arch across open water via barge. This report does not seek to make a specific recommendation for selection of a construction yard, but rather to demonstrate that suitable regional sites exist. Screening of potential construction yards considers the following parameters:

- Distance from the canal
- Horizontal and vertical clearances of existing bridges and structures along travel route
- Availability of bulkhead with deep draft for barge access
- Access to rail and interstate for material delivery
- Commercial availability
- Site conditions and required improvements

Three candidates were identified within 75 NM (nautical miles) of the canal which satisfy the screening parameters: an existing commercial heavy-lift construction facility inside the New Bedford hurricane protection barrier, the decommissioned Somerset Power plant on the Taunton River, and mooring slips on the Weymouth Fore River attached to the Jay Cashman Corporation Marine Facility and to a commercial auto lot.



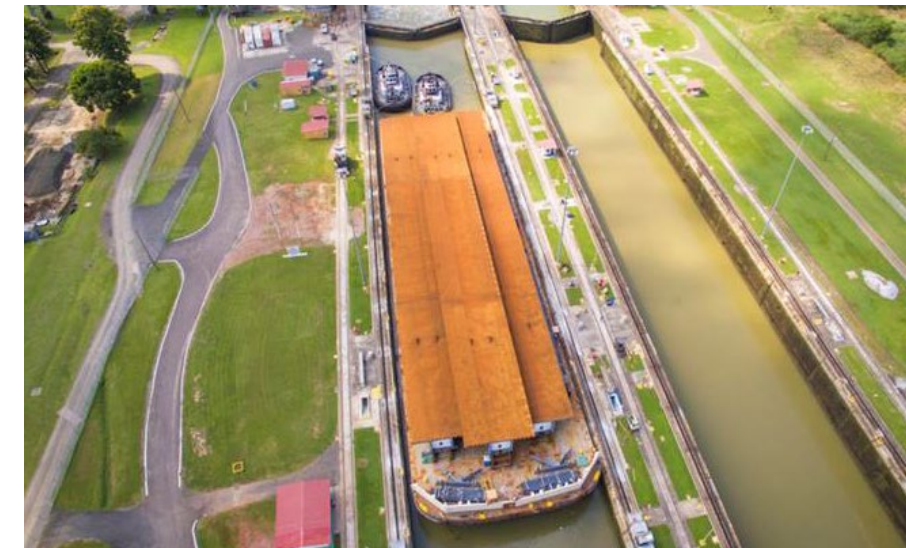


Location	Distance	Horizontal Clearance		Vertical Clearance	
		Width	Feature	Height	Feature
A New Bedford Heavy Lift Construction Facility	21 NM	150'	New Bedford Hurricane Barrier	135'	Canal Bridges
B Somerset Power LLC (Decommissioned)	64 NM	98'	Brightman St Bridge (Decommissioned)	135'	Charles M Braga Jr Bridge
C Weymouth Fore River Slips	50 NM	250'	Fore River Lift Bridge	135'	Canal Bridges

**Fig. 5.3 – Regional fabrication sites and controlling navigational clearances**

The table above lists the controlling horizontal and vertical clearances (at MHW) for features along the anticipated travel route for each location. Vertical clearance at the existing canal bridges, including the railroad lift bridge, is 135'. As discussed in the section below on barges, freeboard requirements for operations in the canal differ from open water operations, and accordingly total transport height should be evaluated independently for each feature. For detailed screening information on these sites and others evaluated, see Appendix A.

While viable regional candidates for fabrication sites were identified, we also consider options further afield in the interest of encouraging competitive bidding by experienced fabricators and erectors. Further north along the coast there are promising sites in Portsmouth, NH and Portland, ME. At a national level, it is feasible to fabricate the arch spans at a specialty construction yard anywhere in the country accessible via commercial shipping. Past projects in the region have utilized structural steel from yards sited along the east coast, inland waterways, or even the west coast with navigation via the Panama Canal.



**Fig. 5.4 – Wittpenn Bridge girders in the Panama Canal**

As an example: the recently completed Wittpenn Bridge in Jersey City, NJ was fabricated in Portland, OR and shipped as five large pieces via barge through the Panama Canal. Consideration of faraway fabrication sites should balance the economic and technical benefits offered by these locations against increased cost and risk of long-distance open-water transport.

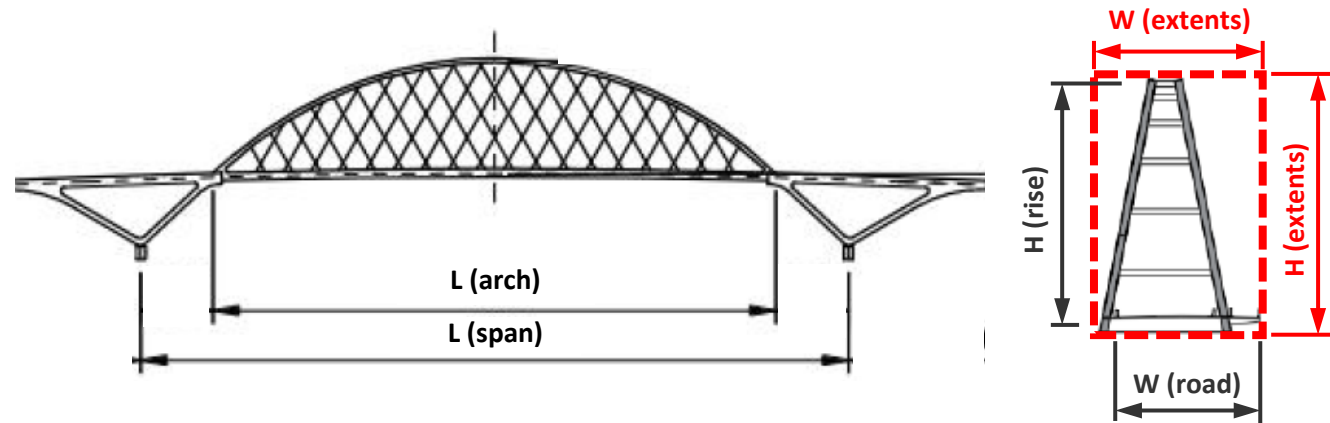
**5.2.2 Transport Considerations**

The following considerations on arch transport via barge are provided for informational purposes and should be considered neither complete nor authoritative. An experienced erection and marine transport engineer shall be engaged for all aspects of design related to marine transport.

To assess barge sizing and evaluate horizontal and vertical clearances along proposed navigational routes, the height, width, and weight parameters in Fig 5.5 are used. Key assumptions include a ratio of arch span to rise between 5:1 and 6:1, out-to-out limit for structure height 7' greater than the nominal rise (from centerline of arch and rib), out-to-out limit for structure width 12' greater than the nominal roadway width, and lift weight represents steel only approximated by multiplying the deck area (excluding sidewalks) by 120psf.

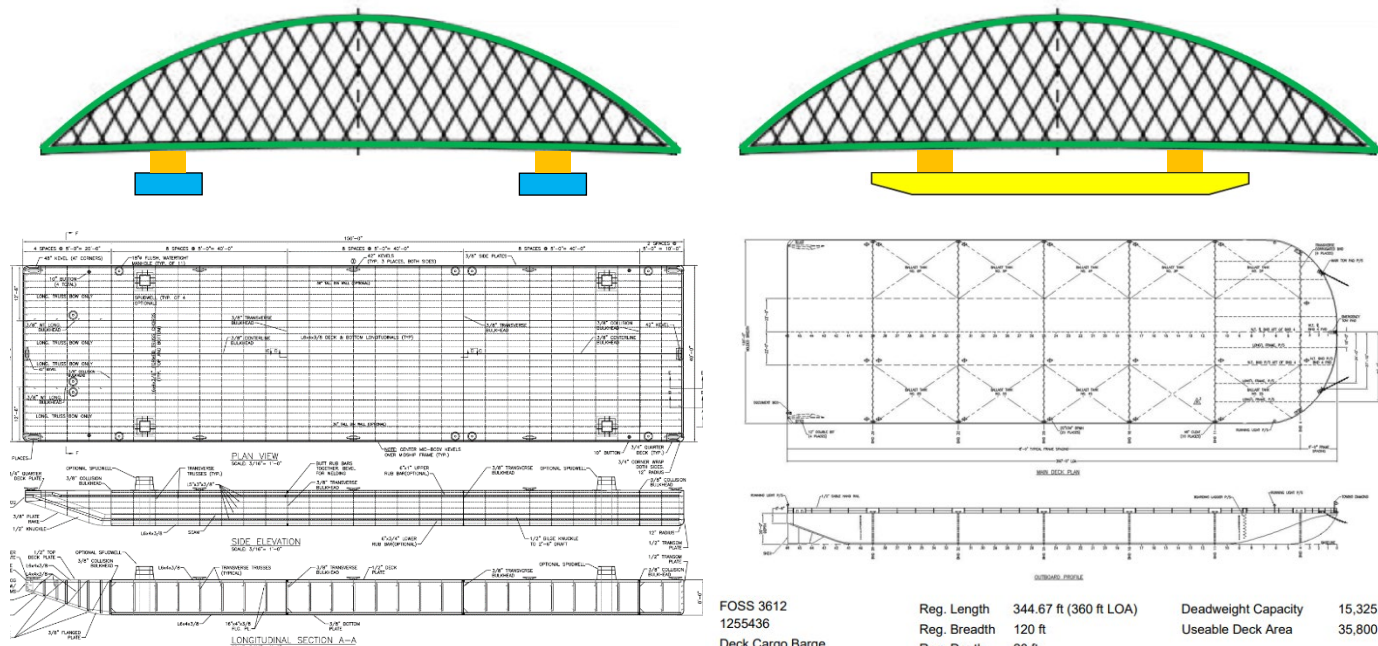
For structure configurations with the shared use path located outside the cable plane, transport width can be reduced by erecting cantilevered walkway floorbeams after the arch has been delivered to site.

Barge selection and layout requires balancing various parameters including load, required freeboard (height between waterline and deck), and stability against overturning. Barges can be oriented parallel or orthogonal to the longitudinal axis of the arch, and multiple barges can be ganged together with struts to carry large loads or improve handling characteristics. Some barges are designed with raked (inclined) bows for hydrodynamic efficiency or include spudwells for mooring against movement due to currents. Barges in the size range of 240'-300' long by 70'-100' wide are widely used and generally available. Large ocean-going barges up to 360' x 120' are also available. See figure 5.6 for example barge sizes and configurations.



Configuration	Arrangement	Span Length	Arch Length	Arch Rise	Road Width	Height	Width	Lift Weight
Tied Arch on Straight Piers	Twin Arches	700'	700'	117'-140'	73'	124'-147'	85'	5,000 kips
Tied Arch on Delta Frame Piers	Single Arch	700'	560'	93'-112'	129'	100'-119'	141'	8,500 kips
Tied Arch on Delta Frame Piers	Twin Arches	700'	560'	93'-112'	73'	100'-119'	85'	4,000 kips
Tied Arch on Delta Frame Piers	Twin Arches	820'	656'	109'-131'	73'	116'-138'	85'	4,500 kips

Fig. 5.5 – Clearance parameters and lift weights for representative arch configurations (delta frame shown)



a) Twin 150' x 40' deck barge with spudwells oriented transversely to span for canal operations

b) Single 360' x 120' deck barge oriented parallel to span for deep water operations

Fig. 5.6 – Example barge sizes and configurations

FOSS 3612  
1255436  
Deck Cargo Barge  
Reg. Length 344.67 ft (360 ft LOA)  
Reg. Breadth 120 ft  
Reg. Depth 20 ft  
Deadweight Capacity 15,325 ST  
Useable Deck Area 35,800 ft<sup>2</sup>

Freeboard requirements change based on operating environment: 2'-3' is recommended in the canal depending on speed and traffic conditions, while open-water operations require 6'-7'. As a rule, barge capacity decreases as freeboard increases. Arches will require cribbing to distribute the load and facilitate loading and unloading, typically a minimum of 6'-8' in depth. Freeboard requirements and cribbing depth must be considered when establishing the total transport height for vertical clearance checks.

Barge stability is a function of the relationship between the center of gravity, the center of buoyancy, and the metacentric height relating the two as a barge rolls. Practically this signifies that as the height of the arch's center of gravity above the waterline is increased, barge stability decreases, and a larger barge is required to safely carry the load.

Tied arches are designed to be vertically supported at the ends of each span where the arch forces naturally resolve. Transport via barge generally requires arches to be temporarily supported elsewhere along the tie (e.g. at quarter points), which forces the tie to carry the rib in bending as a cantilever. Compression struts installed between rib and tie over the intermediate point of support provide an alternate load path during the temporary condition (see Figure 5.7). Strut placement and orientation should be optimized to both minimize rib and tie bending, and to ensure load is not relieved from the suspenders.

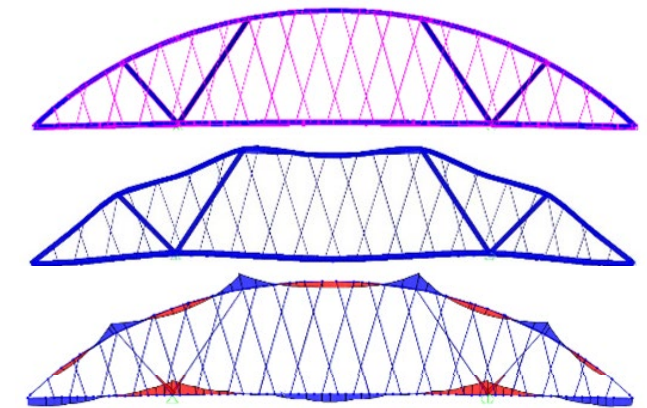


Fig. 5.7 – Temporary strut optimization

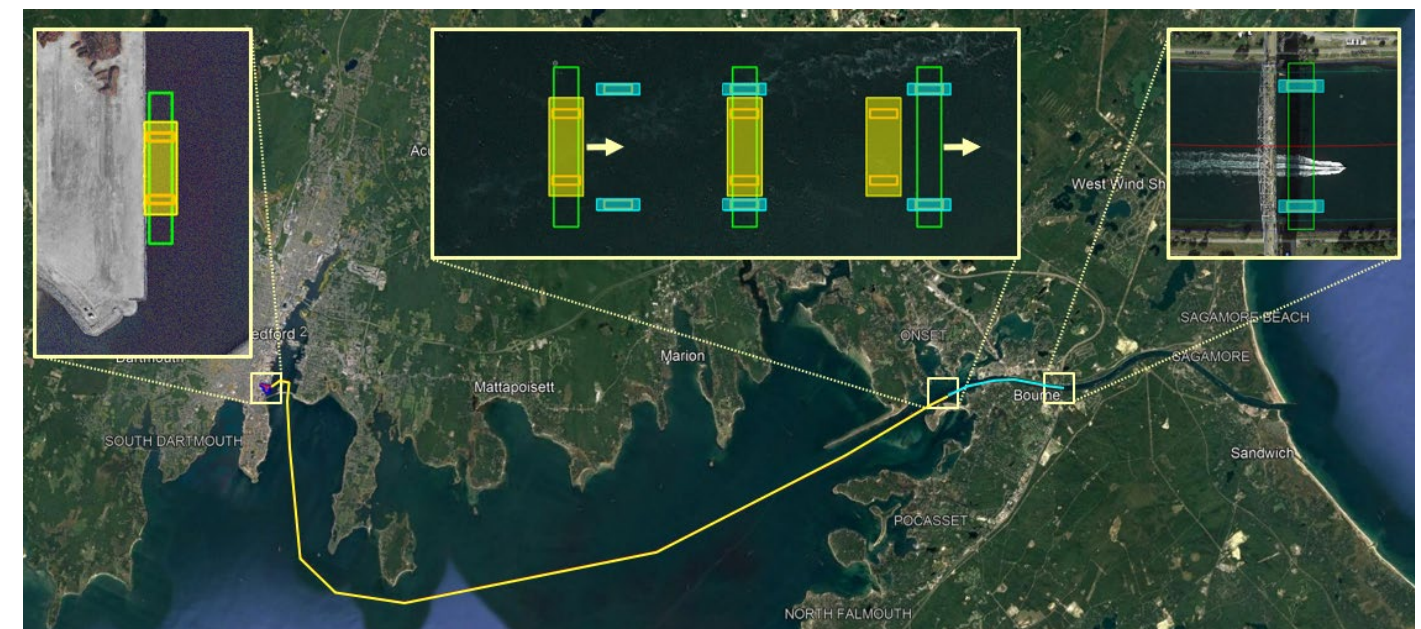


Fig. 5.8 – Conceptual barge transfer between ocean-going (yellow) and canal operations (blue)

The significant 6-knot current which reverses every 6 hours will present a challenge to barge handling in the canal. If a large barge oriented longitudinally to the structure is used for deep-water transport, rotating that same barge across the canal to position the arch for erection will present a large cross section to the canal flow. Fine positioning control in these circumstances may be difficult to achieve with tugs alone. Use of smaller barges ganged together

and oriented transversely to the arch span could mitigate this risk by aligning the barges with the current during erection to improve hydrodynamic performance. It is also feasible to utilize a large barge oriented parallel for open-water transport, then transfer the arch to smaller orthogonal barges to facilitate precision handling within the canal (see Figure 5.8). It is anticipated that any transfer operations would be conducted within sheltered waters and off the main navigational channel. Alternately, a strategy employing winches anchored to dolphins on either side of the canal and span could provide external reaction points to permit fine geometry control.

5.2.3 Erection Considerations

There are a variety of established lifting approaches available to erect a tied arch which has been floated-in, however not all are suitable for the site conditions at Bourne and Sagamore. In particular, the significant height of the final alignment over the water to provide the required vertical clearance will necessitate lifting the arch over 140'. Pier type is a second consideration for lifting strategy, as straight piers require the arch to be lifted offset from the final alignment to a sufficient height to clear the pier caps before it can be translated into position and set in place. In contrast, delta frame girders which cantilever from the piers over the channel permit direct vertical lifting to the final position as there are no interfering elements (see Figure 5.11 and additional discussion below).

Looking at lifting strategies for non-delta frame piers, the question becomes how lifting and transport of the arch span are sequenced. One approach is to construct the arch on fixed shoring towers at the elevation of the final alignment. This has the advantage of simplifying jacking procedures as only a few feet of travel are required to lower the structure onto the pier caps. However, the high elevation of the arch metacenter above the waterline limits transport to very short distances due to barge stability limits. This requires the arch to be constructed along the canal directly adjacent to the final alignment which precludes a high tower strategy at Bourne and Sagamore.



Fig. 5.9 – Broadway Bridge in Little Rock, AK being floated-in on high shoring towers from adjacent erection site

A second lifting strategy utilizes self-erecting jacking towers to raise the structure from below. This approach enables the arch metacenter to remain much closer to the water during transport improving barge stability characteristics and enabling longer distance and open-water operations. Once the arch is in position adjacent to the final alignment, progressive lift jacking towers are used to sequentially raise the arch in small increments, adding segments to the shoring towers as the height increases. The progressive lift systems are complex custom machines which are currently only available from providers in the EU (e.g. Mammoet, Fagioli). The exclusiveness and complexity of these systems can result in high cost and difficulty obtaining schedule commitments for availability. Additionally, based on past projects, the required lift height is anticipated to be at the extreme range of stability for

currently available jacking systems and would likely require multiple towers per corner to ensure adequate factors of safety. As such, progressive lift is not a recommended strategy for arch erection at this site.

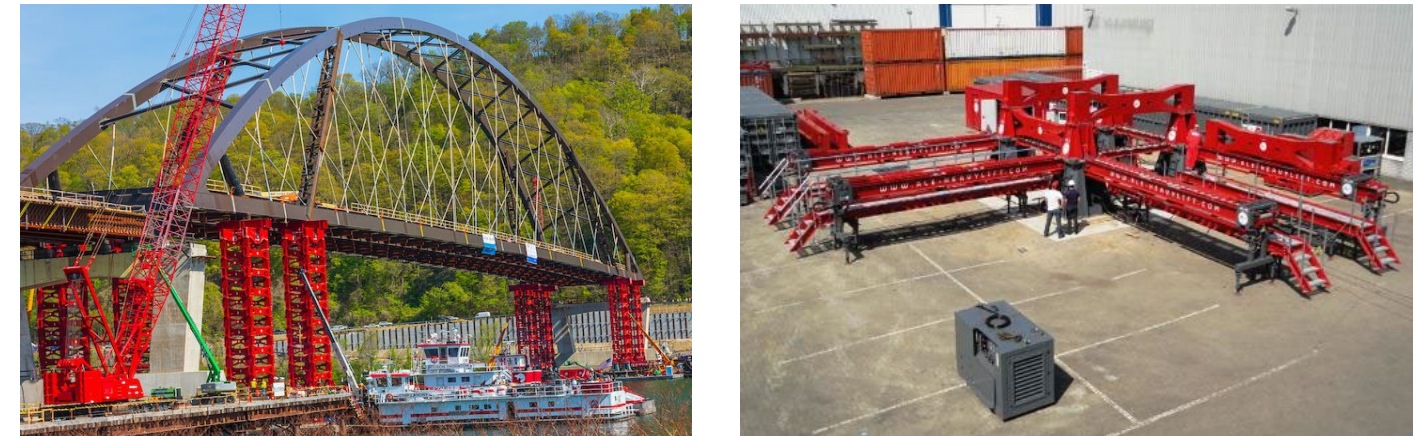


Fig. 5.10 – Wellsburg Bridge in Wellsburg, WV being raised on progressive lift jacking towers

Cranes and hydraulic strand jacks on gantries have also been utilized for lifting of arches onto non-delta piers from above, however the span length and required lift height at Bourne and Sagamore would require large and expensive falsework towers or a complex coordinated pick with up to four cranes simultaneously. These approaches are not recommended due to the cost and associated risk.

With delta frame girders, the support point for the tied-arch span is located over the navigable channel enabling use of a direct lift approach with hydraulic strand jacks. Strand jacks are a type of linear winch where a bundle of cables is guided through a hydraulic cylinder and gripped above and below with anchor wedges. Stroking the cylinder while grips are alternately engaged achieves a sequential lifting or lowering motion with essentially no limits on total lift height. This lifting strategy is well established in industry and utilizes hardware developed for post-tensioning and stay cable stressing.



Fig. 5.11 – Lake Champlain Bridge in Crown Point, NY being lifted by hydraulic strand jacks from delta frames

Strand jacks typically enable lifting at a rate of 10'-20' per hour, with the considerable advantage that once lifting begins, load is immediately transferred to the permanent structure and the erection procedure no longer requires

barges for support or stability. Speed of erection aligns with USACE preference for short-term canal closures over long-term operational impacts. It also mitigates the time-dependent risk of high winds during vulnerable construction stages. As an example, the Lake Champlain Bridge between NY and VT was erected using strand jacks on August 26, 2011, the day before hurricane Irene struck the region. Lifting was completed in 16 hours, at which point the arch was secure in the final stable configuration and able to safely weather the storm.

Design of the delta frames should be sensitive to barge sizing and placement limitations to facilitate transfer and lifting. Due to the need for the end floorbeam and knuckle of the arch to pass through the delta frame, attention must be paid to detailing of the interface between the two components. A strategy successfully utilized on previous delta girder arches holds back segments of the delta girder end beam to leave openings for arch passage. The missing end beam segments are then lifted with the arch span and spliced before the arch is released from the jacks onto permanent bearings.

For the specific site conditions at the Bourne and Sagamore Bridges, all approaches evaluated for lifting of tied arches onto straight piers have substantial drawbacks. In contrast, a cable lifting strategy from delta frame girders appears well suited to the site constraints.

## 6 CABLE STAY CONSTRUCTION

In addition to arches, the initial screening study determined that a cable-stayed bridge is also suited to the site conditions at Bourne and Sagamore. It is anticipated that construction of a cable-stayed bridge would be performed either as balanced-cantilever erection (deck advanced symmetrically from each tower) or as progressive construction (back span on shoring, main span as cantilever).

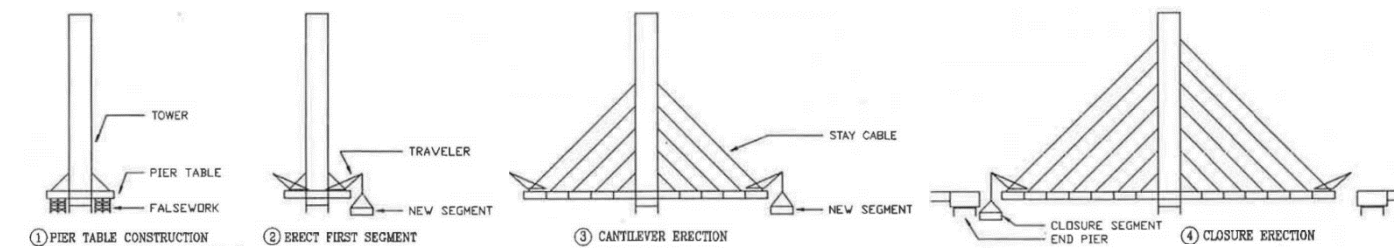


Fig. 6.1 – Typical stages of balanced-cantilever erection

This balanced-cantilever approach (see Figure 6.1) begins with construction of the permanent towers, followed by erection of tower deck segments on ground-supported or pier-supported falsework, commonly referred to as the pier table. There is a preference for span lengths which enable pier table construction from land. From the pier table, the deck is erected segmentally on each side of the tower in a balanced sequence which minimizes load unbalance and longitudinal bending in piers and foundations. Stays are installed as the deck is progressed, resulting in a structure that is self-supporting and can also support erection equipment and construction materials on the cantilever. Balanced cantilever construction is suitable for both precast concrete segmental and steel edge girder superstructures, however the initial screening study identified a preference for open steel edge girders.

With progressive construction, first the back spans are erected on shoring towers, followed by successive installation of shorter main span segments that cantilever over the river span. This method is advantageous if it is desired to deliver materials via the approach and along the previously erected bridge.

Material delivery and handling is a key consideration for balanced cantilever erection. Deck girders and floorbeams are traditionally picked and set from directly below the tip of each cantilever by either deck-mounted derricks or large ground and barge-mounted cranes. Use of large barge-mounted cranes is not preferred as they will present an ongoing navigation obstruction and impact risk throughout a significant portion of the construction duration. Deck-mounted derricks also require service barges to deliver material which will intermittently obstruct the channel.

An alternate strategy is to feed all materials from the shore-side cantilever using a truck or stiff-leg derrick on deck to transport materials to the water-side cantilever. This approach eliminates the need for crane and service barges in the channel, however it requires installation of a temporary or permanent prop in the back span to control deflections and stresses resulting from the moving loads. As an ancillary benefit, a back span prop also provides an alternate load path which can improve stability and resist wind loads during erection.

Cable-stay structures are more susceptible than arches to wind loading during construction due to the unstable double-cantilever condition that exists until closure segments anchor the spans to the approaches at each end. This intermediate erection condition often represents a controlling design case for main structural components. Tower cranes typically used for pylon erection are subject to possible frequent loss of use due to wind conditions at the site. As such, tall pylons extending above the deck may not be preferred due to the risk of delay and associated expense.

One common strategy for mitigating risk in high-wind regions is to develop contingency measures for securing the structure in the event of a hurricane or other major storm. Given the anticipated multi-year project duration required to construct two or four new crossings, it is credible to expect extreme events will occur during construction and develop mitigation measures integral with the design to maximize performance and reliability.

Finally, as with arches, single full-width cable-stay structures will be more challenging to erect than twin independent structures: a single deck will require large floorbeams with considerable pick weights and in general it will be more challenging to control geometry on the larger structure.

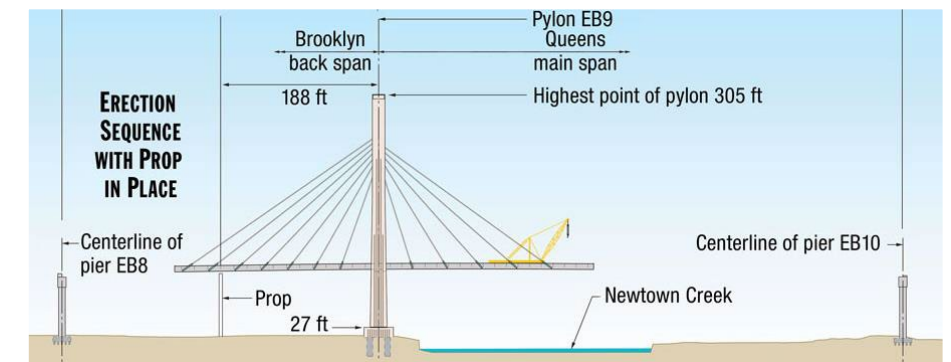


Fig. 6.2 – Construction of the Kosciuszko Bridge in Brooklyn, NY using a stiff-leg derrick to transport materials across the deck

## 7 DEMOLITION

### 7.1 Existing Bridges

The existing Bourne and Sagamore Bridges were completed in 1935 and underwent a major rehabilitation program in the 1980s. The center spans are through arch truss suspended spans with cables suspending the roadway deck from the arch. Decks are steel grids filled with five inches of concrete and topped with a two-inch bituminous concrete surface. Channel piers are pairs of hollow concrete columns sitting on footing pedestals in the canal. Columns are tapered and joined at the top by a concrete strut.

Both bridges are functionally obsolete and rated as structurally deficient with recent inspections noting continuing deterioration of the deck, fatigue sensitive details on fracture critical members, and truss joint gusset plates with significant section loss. Existing conditions and deterioration will have to be taken into careful account in the preparation of the demolition scheme.

A review of historic photographs documenting the original erection of the canal bridges yields several insights which may inform demolition:

- Unlike many arches, the arch truss main span is largely self-supporting under selfweight. It does appear a set of props in the back spans were utilized as hold-downs based on their placement at the line of action where the upper cord projects through the back span deck truss.
- Arch truss and deck steel was erected using travelling derricks riding on the top cord of each truss plane.
- Temporary props were utilized to erect the back span deck trusses.

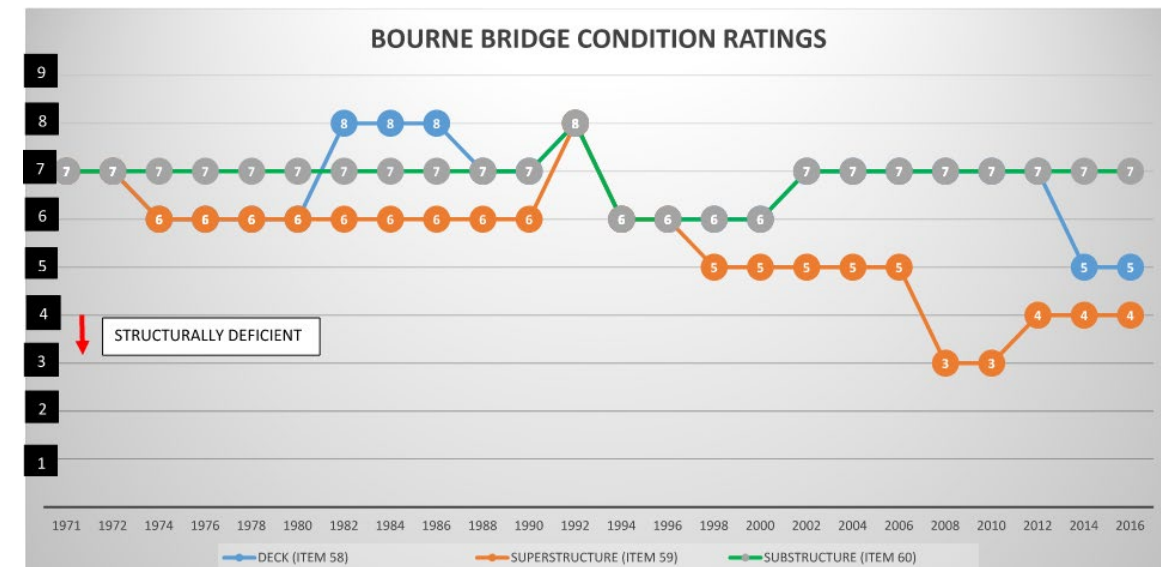


Fig. 7.1 – History of condition ratings for Bourne Bridge (FHWA)

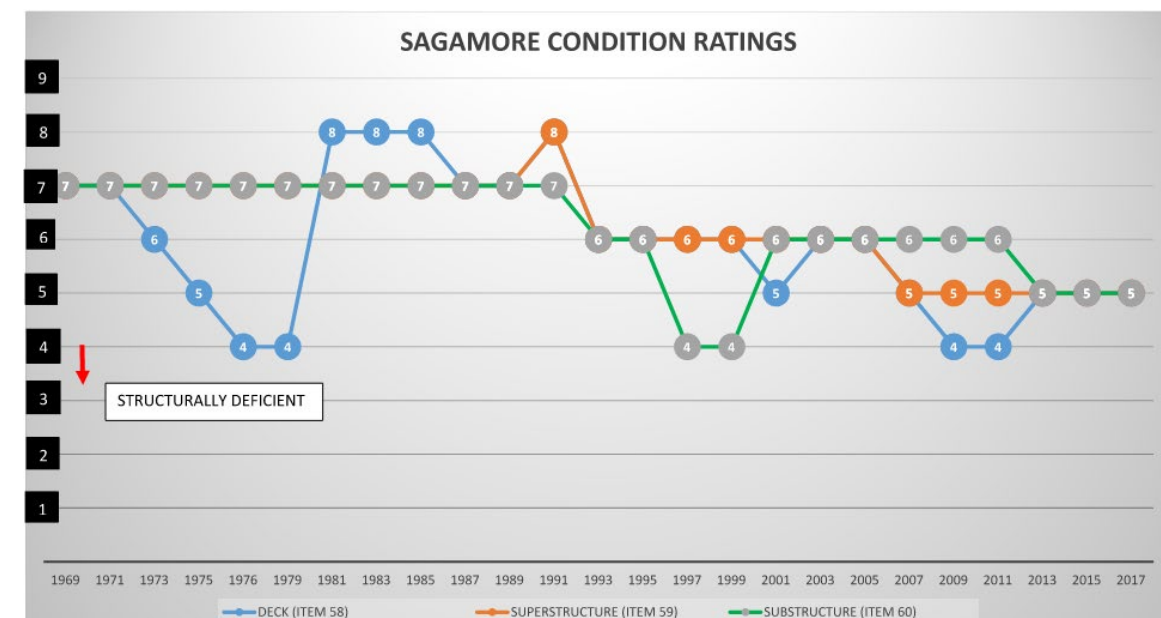


Fig. 7.2 – History of condition ratings for Sagamore Bridge (FHWA)



Fig. 7.3 – Historic photos showing erection of Bourne and Sagamore Bridges (c. 1934)

## 7.2 Methodology

The following considerations on demolition are provided for informational purposes and should be considered neither complete nor authoritative. An experienced demolition engineer shall be engaged for all aspects of design and planning.

It is assumed that all demolition strategies will first remove the steel grid deck and concrete infill. It may be possible to lower entire segments of the floor system to barges for removal, however deck deterioration may make this challenging. Cutting and percussive concrete removal will require shielding below the deck to capture debris and protect the navigation channel.

Demolition of the back span truss and approach deck trusses are less constrained so it is anticipated that any number of traditional demolition approaches would be suitable for these spans. Existing piers and footings should be demolished to below the mud line to remove potential navigation hazards.

Several demolition approaches for the steel arch trusses are presented below for discussion purposes:

### 7.2.1 Reverse Cantilever Deconstruction

Given observations regarding the original erection scheme, it appears piece-wise deconstruction of the arch trusses is feasible. This approach would essentially reverse the construction process. First, any deck framing remaining after concrete removal would be lowered onto barges, in larger segments where feasible. Next, temporary hold-downs and props would be engaged in the back spans as required to maintain stability. The arch truss would be separated into twin cantilevers and deconstructed member-by-member starting at mid-span and working toward the shore. Demolished steel would be lowered onto barges below.

Careful evaluation of the existing structure is required to establish whether it can support modern derricks on top of the arch in its current condition. If not, a large barge-mounted crane would be required to support demolition. This approach enables a high degree of control over the demolition process, but at the tradeoff of a significant duration where the structure is vulnerable, and the wind risk is amplified. Significant numbers of support barges would be required during demolition of the main span to receive deck and truss members. Additionally, attempting to reverse-engineer the construction process without plans detailing the original erection sequence adds risk. Built-up sections and gussets can hide unexpected detailing and unanticipated conditions from even a detailed visual observation.

### 7.2.2 Float-out

Instead of deconstructing the arch member-by-member, it should be evaluated whether a large portion of the arch truss can be removed as a single unit. This approach would require cutting the truss arch inside of the main span piers and lowering it onto barges using strand jacks or tandem cranes. The major benefit to this strategy is that it minimizes disruption to the navigational channel. Care is required when establishing cut locations to ensure the removed section remains stable as it is lowered to the barge and during transport. As with piece-wise deconstruction, the remaining cantilever portions of the arch truss would require use of temporary props in the back spans for stability.

### 7.2.3 Controlled Explosive Demolition

It is expected that use of explosives to drop the existing main and back spans will cause extensive and long-term disruption of canal traffic, adverse ecological impacts, and potential damage to the canal bed. The proximity of approach spans to residential and commercial properties presents an unacceptable risk to the public. As such, explosive demolition of the Bourne and Sagamore bridges is not recommended.

## 8 CONSTRUCTABILITY TAKEAWAYS

### 8.1 Risks

Constructability review of the project site and representative configurations identified the following key risks:

- Extreme weather/wind events can reasonably be expected to occur during construction while the structure is in a vulnerable state.
- Wind interaction between structures may produce adverse aeroelastic behaviors during both temporary (new + existing) and permanent (new + new) span configurations. Cable-stayed structures are more susceptible to these effects than arches.
- Cable-stayed structures are vulnerable to wind loads during certain construction stages and cable-stayed construction operations are more affected by high-wind conditions.
- Cranes, whether tower, land, or water based, will be subject to operational limitations and impacted by frequent winds exceeding safe operational parameters.
- The canal supports sufficient vessel traffic such that barges and temporary supports in the canal are at risk for vessel impact. Objects both within and adjacent to the navigational channel are subject to this risk.
- Canal tidal currents create a challenging environment for barge operations.
- Elevation of the proposed alignment is at the limit of barge-based lifting capacity for stability.
- Cape Cod Railroad operations will constrain construction activities along south shoreline
- Deep foundations are necessary and there is a risk of encountering boulders at depth, complicating installation of piles, drilled shafts, or other deep foundation elements.
- Single deck configurations are at the limit of transportability, erectability, and interim stability. Wide decks necessitate large floorbeams, require increased crane capacity, and enhance complexity of geometry control as rotation makes field connections difficult.

### 8.2 Recommendations

Based on the findings of this report, the following recommendations are presented:

- Erection strategies are preferred which avoid the need for temporary piers in the water and, in general, minimize in-water work. This risk is time dependent: if barge operations or temporary piers are required, duration of navigational obstruction should be minimized to reduce the likelihood of ship impact.
- USACE prefers short-term canal closures over long-term operational restrictions in the channel.
- Material delivery via water is not recommended due to lack of existing bulkheads local to the alignments. Barges cannot moor close enough to shore for land-based crawler cranes to hoist materials without construction of in-water facilities within an environmentally sensitive area.

- Risk associated with extreme weather and wind is time dependent: bridge configurations and construction strategies which minimize the duration a structure is vulnerable during erection are preferred. A site-specific meteorological study is strongly recommended to establish wind parameters for both permanent design and construction loading.
- In contrast with cable-stayed bridge erection, float-in construction of a tied arch enables the structure to be installed as a complete, stable unit. Duration of the critical lifting operation is minimal and can easily be scheduled to take advantage of favorable weather conditions.
- No suitable arch fabrication sites exist along canal, however offsite fabrication and open-water transport is feasible.
- Twin structures offer constructability and phasing benefits over single structures due to smaller member sizes, simplified geometry control, and ability to sequence construction of new spans with demolition of existing spans.
- Tied arches on delta piers are preferred over straight piers due to simplified lifting operations and to avoid the challenge of maintaining barge stability while lifting the arch to the elevation required for installation on straight piers.
- Demolition of the existing bridges via reverse cantilever deconstruction appears feasible based on historic information.

#### Key takeaways:

- **For spans in the range of 700', twin tied arches on delta piers lifted using strand jacks is a configuration and erection methodology well suited to site conditions.**
- **For spans in the range of 820', twin cable-stayed bridges configurations are also well suited to site conditions but are subject to increased wind risk during construction relative to tied arches on delta piers.**

# Appendix A

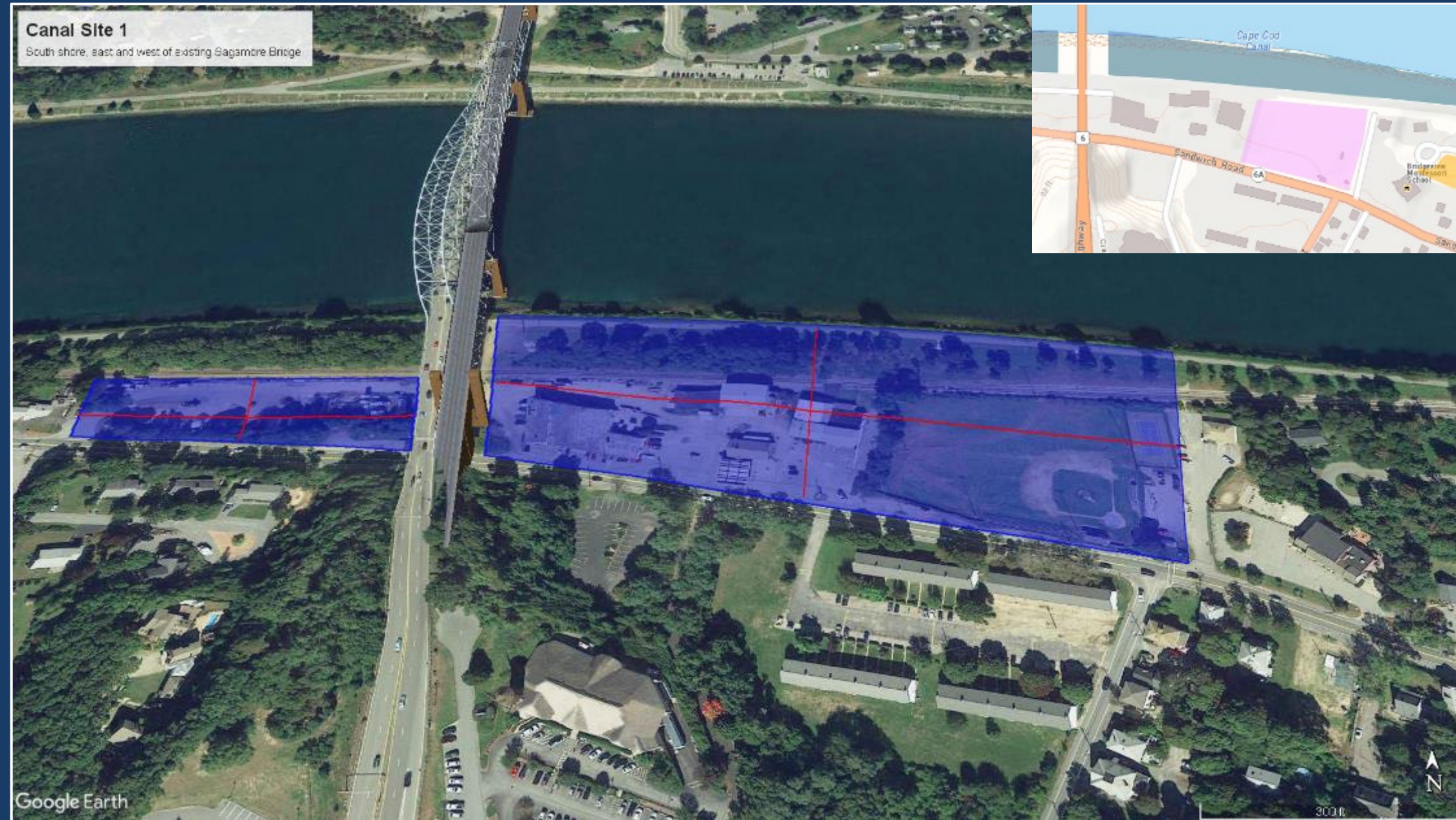
## Fabrication Site Screening



# Construction Sites - Canal - Sagamore Bridge

## Site Details (east + west)

- Length = 1000' + 500'
- Width = 400' + 150'
- Area = 10 acres + 2 acres
- Distance = 0 NM
- Owners / Stakeholders:
  - Mixed commercial
  - Keith Field Recreation Area (municipal, Town of Bourne)
  - Cape Cod Canal Access (federal, USACE)



## Pro

- Commercial property may be available for use as laydown/fabrication area
- Proximity to site
- Canal water access

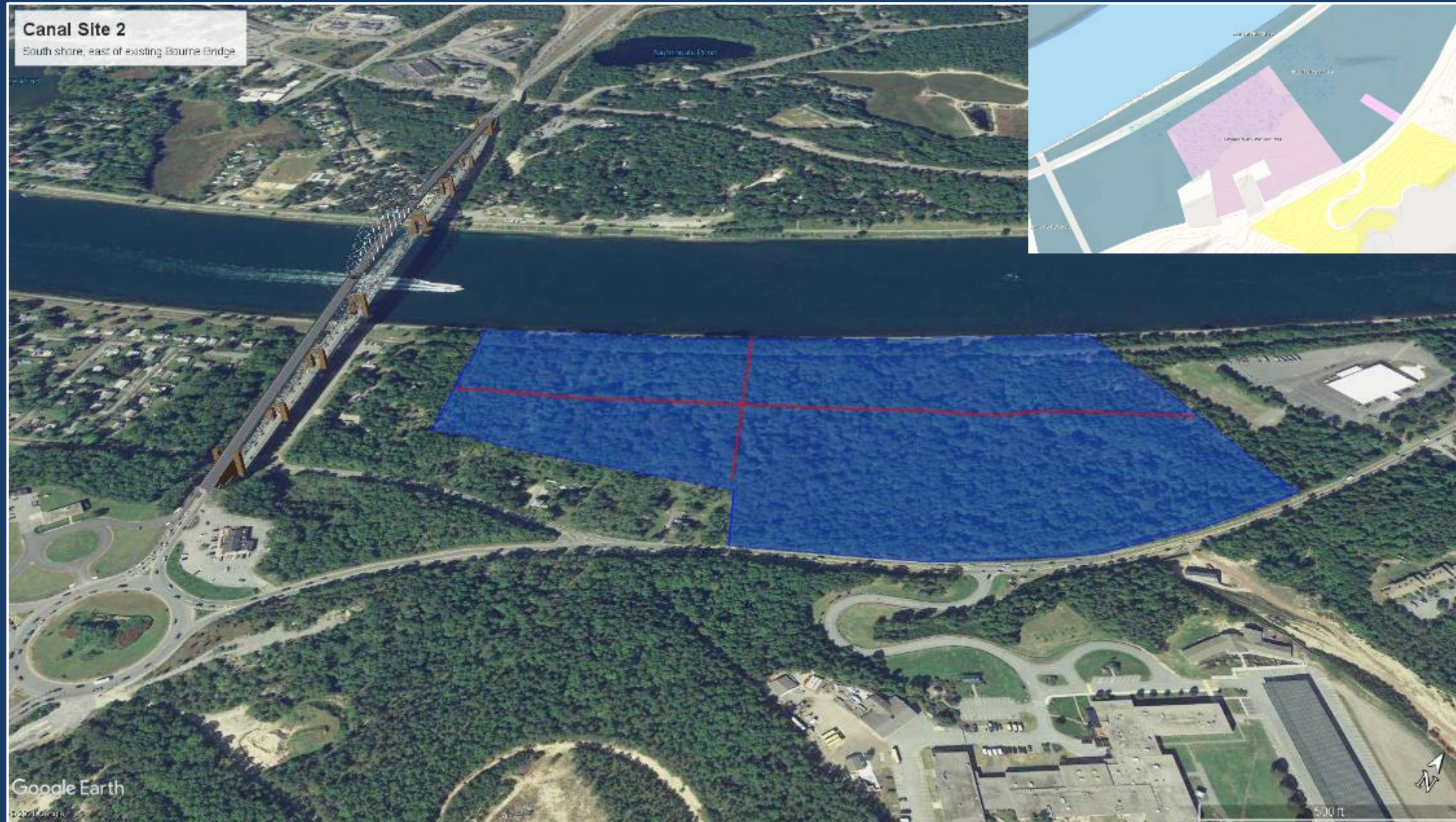
## Con

- Mass Coastal Railroad runs through site
- Size constrained by surrounding residential
- Eastern 400' section requires taking/restoring municipal recreation area (baseball field, tennis court, etc.)
- No existing bulkhead or dock

# Construction Sites - Canal - Bourne Bridge

## Site Details

- Length = 2100'
- Width = 750'
- Area = 46 acres
- Distance = 0 NM
- Owners / Stakeholders:
  - Sandwich Road Conservation Area, aka "Labretto Property" (municipal, Town of Bourne)
  - Cape Cod Canal Access (federal, USACE?)



## Pro

- Proximity to site
- Canal water access

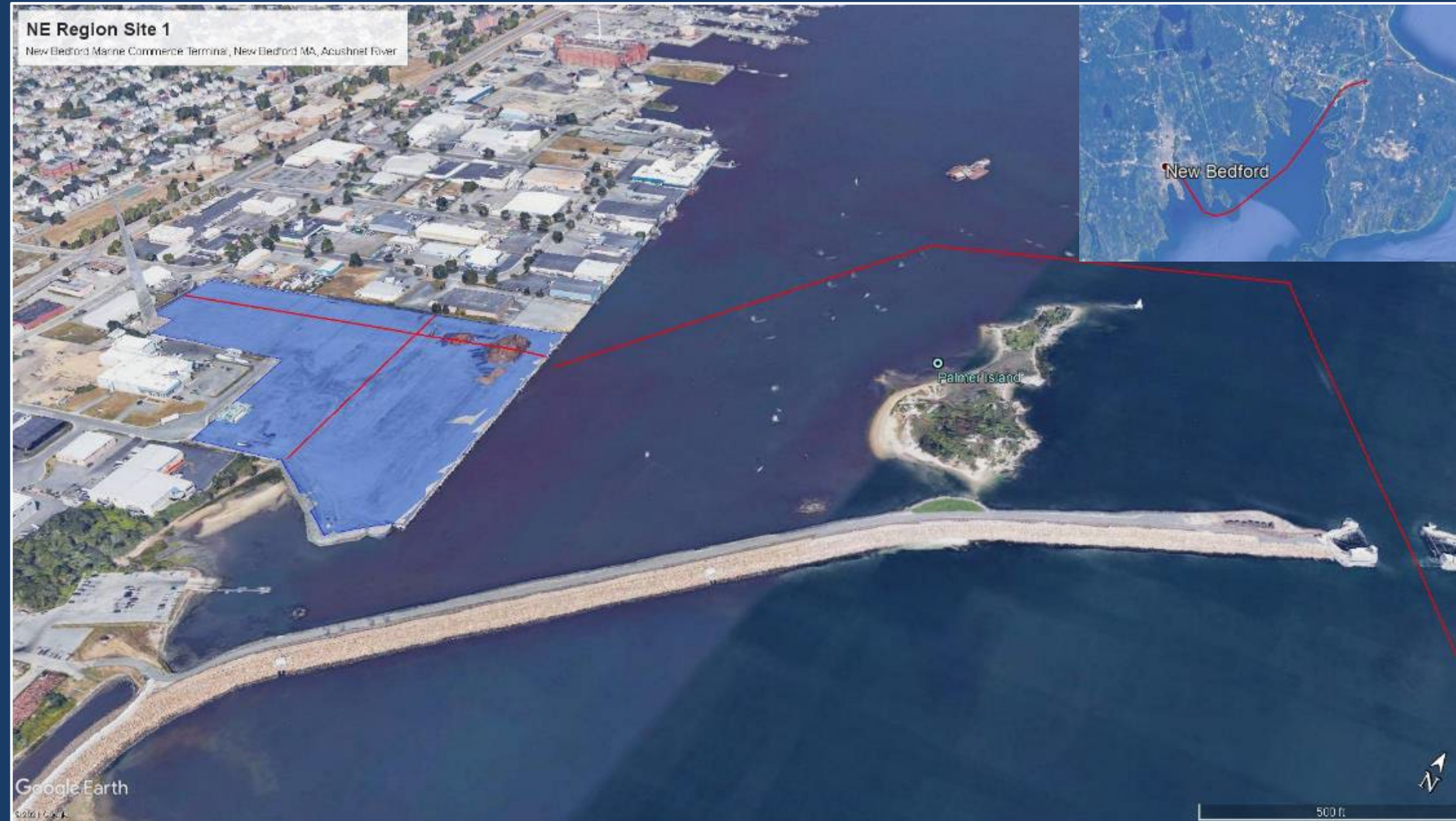
## Con

- SRCA (pink inset) is undeveloped conservation land
- Upper Cape Regional Tech School seeking to obtain access and management rights (2019)
- No existing bulkhead or dock

# Construction Sites - Northeast Region - New Bedford

## Site Details

- Length = 1250'
- Width = 825'
- Area = 20 acres
- Distance = 21 NM
- Owners / Stakeholders:
  - New Bedford Marine Commerce Terminal (commercial)



## Pro

- Commercial heavy-lift construction facility (offshore wind)
- 1000' of bulkhead (35'+ draft access)
- High uniform load capacity yard/quay
- Nearby rail and interstate access (I-95 / I-495)

## Con

- New Bedford Hurricane Protection Barrier horizontal clearance = 150'

# Construction Sites - Northeast Region - Acushnet River

## Site Details

- Length = 850'
- Width = 350'
- Area = 7.5 acres
- Distance = 24 NM
- Owners / Stakeholders:
  - City of New Bedford



## Pro

- None

## Con

- No existing bulkhead
- I-195 & Coggeshall Street fixed span roadway bridges restrict access to Buzzards Bay
- New Bedford-Fairhaven Swing Bridge horizontal clearance = 95'

# Construction Sites - Northeast Region - Taunton River

## Site Details

- Length = 900'
- Width = 400'
- Area = 8 acres
- Distance = 64 NM
- Owners / Stakeholders:
  - Somerset Power LLC, decommissioned (commercial)



## Pro

- Decommissioned plant and property available
- 600' of bulkhead (35' draft depth)
- Nearby interstate access (I-195)

## Con

- Veterans Memorial Bascule Bridge horizontal clearance = 200'
- Brightman St Bascule Bridge horizontal clearance = 98' (bridge decommissioned but not demolished)
- Charles M Braga Jr Fixed Bridge vertical clearance = 135'
- Existing bulkhead and yard require rehabilitation

# Construction Sites - Northeast Region - Weymouth Fore River

## Site Details

- Area = 16 acres
- Distance = 50 NM
- Owners / Stakeholders:
  - Cashman Dredging & Marine Construction



## Pro

- Construction yard
- Multiple slips/bulkheads
- Nearby rail and interstate access (I-93)
- Fore River Lift Bridge horizontal clearance = 250'; vertical clearance = 220'

## Con

- Dependent on engagement/availability of Cashman

# Construction Sites - Northeast Region - Weymouth Fore River

## Site Details

- Length = 1000'
- Width = 175' / 250'
- Area = 12 acres
- Distance = 50 NM
- Owners / Stakeholders:
  - Quirk Auto Dealers (commercial)
  - ABC Supply Co. Inc. (commercial)



## Pro

- 800'x150' slip (28' draft depth)
- Nearby rail and interstate access (I-93)
- Fore River Lift Bridge horizontal clearance = 250'; vertical clearance = 220'

## Con

- Site not advertised as available
- Portion of yard constructed over old slip; load capacity may be reduced

# Construction Sites - Northeast Region – Portland ME

## Site Details

- Area = 28 acres
- Distance = 121 NM
- Owners / Stakeholders:
  - Cianbro Deepwater Marine Facility



## Pro

- Construction yard
- 600' deepwater bulkhead
- Nearby rail and interstate access (I-295)
- Casco Bay Bridge horizontal clearance = 196'

## Con

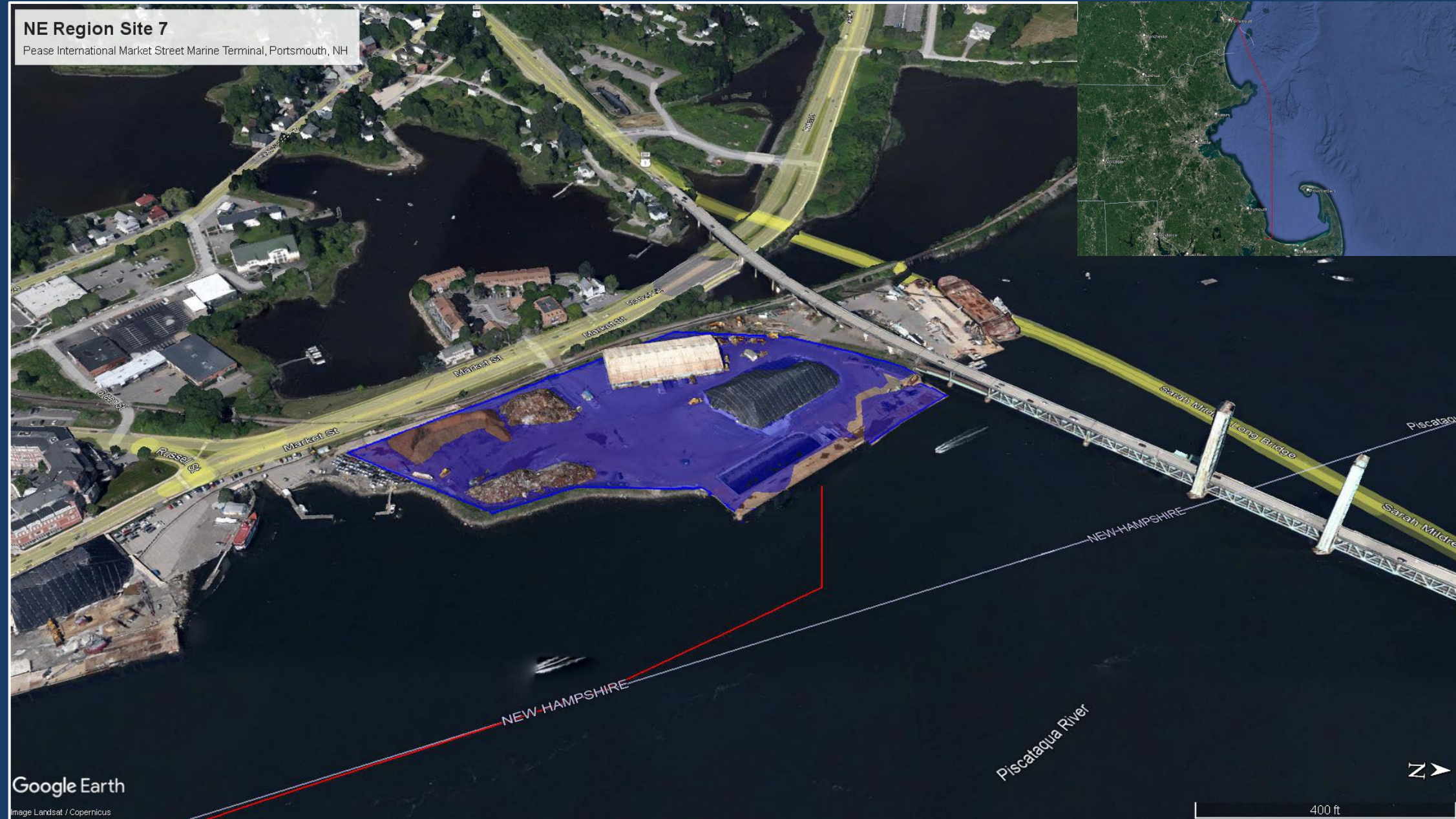
- Dependent on engagement/availability of Cianbro



# Construction Sites - Northeast Region – Portsmouth NH

## Site Details

- Area = 9 acres
- Distance = 85 NM
- Owners / Stakeholders:
  - Pease International Division of Ports & Harbors (NH State Port Authority)



## Pro

- Construction yard
- 600' deepwater bulkhead
- Onsite rail and nearby interstate access (I-95)
- Memorial Bridge horizontal clearance = 260'; vertical clearance = 129'

## Con

- Marine terminal availability for construction
- Upcoming major rehabilitation of main wharf

# Appendix B

## Site Visit Memo

# TECHNICAL MEMORANDA

**To**

John Smith, Ted Zoli

**From**

Tom DeHaven

**Cc**

Justin Steinhouse, Gregor Wollman

**Project**

Cape Cod Bridges Replacement

**Subject**

Cape Cod Bridge Site Visit on  
November 19, 2021

**Date**

November 19, 2021

Today, Tom DeHaven visited the site of the two Cape Cod Bridge with John Smith and Mike Beintum.

We went to the Sagamore and Bourne Bridge sites. The purpose was to compare and contrast these sites with each other and with the C&D Canal Bridge site in Delaware. Tom DeHaven spent 5 years as the Resident Engineer during the new construction of the C&D Canal Bridge across a canal that is managed by the USACOE. Were any of the lessons learned during the C&D Canal construction applicable to the decision-making matrix and risk matrix for the new bridges in Cape Cod?

The C&D Canal bridge at first glance is very similar to the Cape Cod Canal. Both at about 625' wide, with similar depth and rip rap along the shores. Both have large ships and barges using the canal frequently. Both have canal access roads on each side for use by the USACOE. Both have 135' vertical clearance and will require long approach spans to get the roadway down to roadway level at a 4-5% grade.

There are some noted differences. Especially for the Sagamore Bridge where there is a lot of residential development very close to the bridge and its approaches. This significant amount of residences in close proximity to the bridge results in a substantial number of pedestrians walking along the canal access. The C&D Canal was rather remote, unpaved, and not utilized much by pedestrians or cyclists. Another major difference is the wind. The wind at both Cape Cod sites was noticeable at ground level and then especially while driving over the bridges. It is noted that this was considered by locals to be a calm day and we were told that most days the wind blows much harder. The final noted difference is the canal flow. The Cape Cod flow is strong and

changes with the tide. It is ripping along and with little slack tide. The C&D flow was very gentle and was easily managed by construction boats and barges.

Some constructability considerations include:

- **Construction access from barges.** On C&D it was assumed that most materials could easily be delivered by barge and off loaded by land-based crawler cranes. During construction it quickly became evident that the land-based cranes could barely reach a barge over the rip rap and shallow areas. Even if they could reach the barges, they had very limited capacity at that radius. Also securing a barge to off load was not easy without installing piling for anchor points. The C&D contractor eventually installed a stiff-legged derrick to lift heavy loads off barges that were anchored close to shore. This was a slow process, and the stiff-leg derrick was founded on piling in the rip rap and it still conflicted with the canal access road. On C&D, all typical construction materials were delivered over land. The point is that the new Cape Cod Bridges should not be based on canal delivery except in limited circumstances.
- **Wind on Tower Cranes** – On C&D Canal, tower cranes were used to construct the pylon towers that went up to about 300'. There were days when the tower crane was not used to high winds but they were the exception. In my experience, (tower cranes on three cable-stayed bridges where I was on site) tower cranes cannot be utilized when the winds exceed 25 mph. Pylon construction has always been a Critical Path element on every project schedule and this would need to be factored into a project construction schedule.

An example of this impact is the Ironton-Russell Bridge in Ohio. It is a cable-stayed bridge across the Ohio River between Ohio and Kentucky along a river gorge. This gorge experience high winds especially above 100'. ODOT bid the project and all of the bids were in excess of 120% of the estimate. ODOT performed interviews with the bidders and found that all of them were bidding an extra year of construction and including the Liquidated Damage and overhead for that year. The reason given for the extra year was that their analysis of the winds that the tower

**New Ironton-Russell  
Bridge**



cranes would experience severely limited the number of days where the tower could work due to high winds. ODOT had to redesign the bridge to have two pylons instead of one to lower the pylon height and modify the project schedule to allow for more time and then re bid the project after a delay of over a year.

**Based on the site visit today, it is imperative to perform a meteorological study to review the impact of high winds on construction with special consideration on tower cranes or cranes above deck level.** From my C&D Canal experience, it is not clear that we could have built that bridge in the same schedule at Cape Cod due to the stronger wind forces.

- **Extreme Weather event-** Many long span bridges have the design controlled by a construction case where the bridge is in long cantilever but not connected to the approaches. An extreme wind event in that condition would be challenging for a bridge to withstand without taking extreme measures to tie-down the bridge. Contractors, especially along coastal areas, often have plans to secure the structure in the event of major storms like hurricanes. From the site visit, it appears that this area could very easily experience a major wind event where the bridge under construction is taxed to its limits. If the bridge were in pure cantilever and collapsed then it could either damage the existing bridge and/or foul the canal. Again, strongly recommend studying the possible wind events that might impact these sites and consider that strongly in the Risk Analysis. Many of these extreme wind events occur during the warmer times of the year when the contractor is actively working and for a multi-year projects with four canal crossings, it is very conceivable that there will be extreme wind events during construction and this major Risk should be mitigated however possible. This is not just a concern for delays or claims, there potential risk of damaging the existing bridges or fouling the canal.
- **Another constructability consideration is public access through the project site-** While there is always a desire to allow the public to keep the typical access for walking and cycling, it is simply unsafe and unwise to mix the public and active construction. The Contractor is placed in an unfair position of having the general public accessing a construction site. This is an unwarranted risk to the public and to the Contractor. On the Bourne Bridge, there is a campground to the east and it would be unwise to allow that to be access from the west across the new construction site. Strongly recommend finding alternate egresses; shutting off this access and begin a PR campaign to alert the stakeholders why this access will be limited for public safety. Consider Denial of Access Fencing and locked gates across the access road during the construction project.
- **Another constructability issue is the access for beams for the approach spans-** The approach spans will be either steel or concrete beams with a cast-in-place deck. Access for delivery of the spans looks feasible by land delivery. Delivery by barge does not seem practical. One potential option to be explored is the use of the rail line on the east side of the canal for delivery of project materials and possibly even beams. For the beam delivery the existing bridges and their capacity need to be reviewed and delivery limitations established. Special attention needs to be paid to the capacity of the concrete deck beams in the hollow abutments.
- **Another constructability issue to consider is the availability of concrete for the project-** The project will require large volumes of concrete for the footings, piers and bridge decks. The area has very challenging traffic flow during large portions of the year. Will the contractor be able to ensure consistent and timely delivery of concrete from off project batch plants? Should the contractor be required to establish an on-site batch plant specifically for this project? The location for such a plant and the waste from such a plant need to be considered.

# Appendix C Cape Cod Bridge Replacements Phase II Screening Report



CAPE COD BRIDGE REPLACEMENTS

# Phase II Screening Report

PREPARED BY



FOR



2022

## Cape Cod Bridges – Phase II Screening Report

### 1 INTRODUCTION

The existing Cape Cod bridges have reached the end of their useful economic life and need replacement. In an initial screening study, documented in a separate report, a large number of bridge design parameters and bridge types were evaluated systematically in order to arrive at a selection of feasible and favorable options for replacement bridges. The initial selection included cable-stayed, haunched concrete box girder, and tied arch bridges (Table 1). During the second phase of the screening, documented in the present report, the initially recommended alternatives were tested against highway design constraints and were evaluated in greater depth for constructability. For the most promising bridge types (tied arch and cable-stayed bridge) their performance under wind loads was investigated in wind tunnel tests. Based on feedback from these studies it was possible to further refine and reduce the initial selection of feasible bridge types.

### 2 HIGHWAY GEOMETRICS

A particular challenge for the site is the bridge height needed to accommodate the required vertical clearance over the navigation channel. Gaining the necessary highway elevation places great demands on grade and length of the approach spans and ramps. This constraint significantly penalizes the alternatives requiring more structure depth below the roadway, i.e. the box girder option. On the other hand, it favors the cable supported options (arch or cable-stayed) which require only a relatively shallow deck girder. For the same reason a side by side two-deck configuration is preferable to a single, wide deck because floorbeams have to span a shorter distance and, therefore, can be made more slender.

Another assessment criterion that evolved from the highway design studies is the tie-in of vehicular and pedestrian ramps into the main line. Options with two separate shared-use paths turned out to be infeasible and were eliminated from further development. In addition, this consideration favors the tied-arch options because the lack of a cable-supported back span provides the flexibility to tie in any ramps closer to the canal.

### 3 CONSTRUCTION

The complete constructability assessment is documented in a separate report. Following below is a brief highlight of the findings obtained during that study which allowed for further narrowing of the recommended bridge types.

#### 3.1 Impact on Canal traffic:

Feedback from the Army Corps of Engineers and from a constructability and risk assessment ruled out alternatives that require falsework in the canal or frequent construction activities from the canal. This constraint eliminated tied arch construction on shoring. For cable-stayed bridges it dictates that the bridge be erected in balanced cantilever or progressive cantilever with new segments fed via the shored back span on land to the work front over the canal.

#### 3.2 Float-In Option:

With a tied arch alternative there is the option to assemble the steel structure in a remote fabrication yard, transport it to site on an ocean-going barge, and lift it into place. This construction scheme minimizes impact to canal traffic, requiring a short closure (12 to 24 hours) only during the lifting operation. To keep barge sizes reasonable and considering the limited vertical clearance underneath the existing canal bridges, this option favors the 700-ft span arches with two decks and supported on Delta frames. With the Delta frames, the new arch can be positioned between the piers in its low position allowing for quick and stable lifting operation using strand jacks.

Vertical piers would require raising of the arch on the barge in an off-line position so that it clears the piers as it is moved into place. The required lifting height of some 140 feet on barge is at the edge of feasibility and was deemed undesirable, leading to elimination of the vertical pier options.

#### 3.3 Cable-Stayed Bridge Tower Construction:

Erection of cable-stayed bridge towers requires the use of tower cranes, which are subject to severe operation restrictions in windy conditions. Given the exposed site, this limitation creates a considerable schedule risk. The 820-foot cable stayed bridge has constructability advantages over the 700-foot span length as the towers are fully on land.

#### 3.4 Phased Construction:

Alternatives using the two-deck configuration also emerged as favorable because they afford the opportunity for phased construction. With this scheme a new bridge is built parallel to the existing structure. It then carries traffic in a temporary configuration, while the old bridge is demolished, and a new second-phase bridge is erected. This approach provides flexibility during construction and, while potentially increasing total construction time, will accelerate the schedule to decommissioning of the existing bridges. This latter advantage is significant in view of the high cost of maintaining the existing bridges and considering the risk and high user cost of loss of service.

### 4 UPDATED SCREENING MATRICES

Appendix A includes the updates to the screening matrices. Alternatives eliminated after the initial screening are indicated by the grey underlay and alternatives no longer recommended in this second stage screening are highlighted in orange. Where ratings or notes have changed, notes are shown in red. Following below is a summary of the changes to the screening matrices:

- Main Span Length: No changes.
- Deck Configuration: Only the option with separate decks and single shared-use path was retained.
- Single Bridge: No longer considered.
- Separate Bridges: No changes.
- Bridge Types with 700-ft Span: Box girder option is feasible, but not recommended. Cable-stayed option was removed from further consideration in favor of the 820-foot span.
- Bridge Types with 820-ft Span: Box girder option is no longer being considered. Cable stayed option is feasible, but not recommended.
- Cable-Stayed Bridge Towers: Cable-stayed bridge type no longer being considered.
- Cable-Stayed Bridge Pylons: Cable-stayed bridge type no longer being considered.
- Arch Ribs: Tied arches with vertical piers and all alternatives associated with single deck were eliminated.
- Box Girders: No longer being considered.
- Deck Girders: Box girder options, either cable-supported or self-supporting, no longer recommended due to structure depth.
- Approaches: Only the alternative using steel plate girders was retained. The other options (steel box girder, precast concrete girder, concrete box girder) were deemed to be not feasible with the required span lengths and limited access for the approach spans.

### 5 UPDATED PROPOSED CONFIGURATIONS

Based on the feedback from highway design, constructability assessment and wind tunnel studies, the most favorable main span bridge option was found to be parallel network tied-arch bridges supported on Delta frames



with a main span of about 700 feet. 820-foot cable-stayed and 700-foot concrete box girder options are feasible, but not recommended. This preliminary recommendation will be presented at the Round 4 public meetings in November 2022 to receive public feedback on the recommended option from stakeholders and the public. Exact span length, deck configuration, arch rib configuration, tie-in with approach ramps and other parameters would be determined in the bridge type study. Table 1 summarizes the proposed bridge types and configurations; alternatives no longer being considered are crossed out; alternatives feasible but no longer recommended have been crossed out with a dashed X.

TABLE 1 - PROPOSED BRIDGE TYPES AND CONFIGURATIONS FOR FURTHER EVALUATION											
Type	Two-Tower Cable Stayed with Two Cable-Planes 										
Label	CS1	CS2	CS3	CS4	CS5	CS6	CS7	CS8	CS9	CS10	CS11
Deck	Single Deck					Separate Decks					
Span	820 feet 					700 feet 			820 feet 		
Tower	H	V	Single A	Single Y	Pylon	Separate H's	Separate A's	Merged A's	Separate H's	Separate A's	Merged A's
Girder	Edge Steel I-Girder 										
Type	Tied Arch 		Tied Arch with Delta Frames 								
Label	TA1	TA2	TA3	TA4	TA5	TA6					
Deck	Separate Decks		Single Deck		Separate Decks						
Span	700 feet 		700 feet 		820 feet 						
Rib	Basket Handle Ribs 		Vertical Ribs 		Basket Handle Ribs 						
Girder	Edge Steel Box Girder 										

Type	Box Girder 
Label	BG1
Deck	Separate Decks
Span	>700 feet 
Girder	Post-Tensioned Concrete 

No longer being considered  
 Feasible but not recommended

## APPENDIX A – UPDATED SCREENING MATRICES

MAIN SPAN LENGTH		Minimum - 525 ft	Status-Quo - 616 ft	Shore Line Piers - 700 ft	Land Piers - 820 ft				
EVALUATION CRITERIA		Rating	Notes	Rating	Notes	Rating	Notes		
INITIAL COST	Main Span Structure	●●	Lowest superstructure cost.	●	Intermediate superstructure and foundation costs.	●	Intermediate superstructure and foundation costs.	●●	Highest superstructure cost.
	Main Span Foundations	●●	Highest foundation cost, designed for vessel impact, construction access, requires cofferdam.	●●	High foundation cost - access, cofferdam.	●	Close to land, but still requires cofferdam in tidal zone.	●●	Best accessibility for foundation construction.
	Overall	●●		●●		●●		●●	
HIGHWAY GEOMETRICS	Grade/Length	●●		●●		●●		●●	
	Footprint	●●		●●		●●		●●	
	Horizontal Tangent Length	●●		●●		●●		●●	
MAINSpan FOOTINGS	Vessel Impact	●●●	Not acceptable for canal operations.	●●	Small vessels and shallow draft barges.	●●●	Large vessels ground out, small vessels only.	●●●	Not possible.
	Scour	●●		●●	No significant scour with existing structure.	●●	Armored slope.	●●●	Not possible.
CONSTRUCTION	Phasing	●●		●●		●●		●●	
	Duration	●●	Construction from water.	●		●		●	
	Constructability	●●	Pier construction from trestle bridge.	●	Trestle bridge or causeway.	●●	Pier construction from land.	●●	Pier construction on land.
	Impact on Canal Traffic	●●	Most channel fouling.	●		●●	No channel fouling.	●●●	No channel fouling.
	Maintenance of Traffic	●●		●●		●●		●●	
	Environmental Impact	●●	Pier footing in water.	●●	Pier footing in water.	●	Pier footing tucked into shore line.	●●	Pier footing on land.
STRUCTURAL REDUNDANCY	Fracture-Critical Members	●●		●●		●●		●●	
	Failure-Critical Members	●●		●●		●●		●●	
INSPECTION & MAINTENANCE	Access	●●		●●		●●		●●	
	Frequency	●●		●●		●●		●●	
DURABILITY	Protection	●●		●●		●●		●●	
	Replacement	●●		●●		●●		●●	
	Monitoring	●●		●●		●●		●●	
WIND RESPONSE	Structural Efficiency	●●		●●		●●		●●	
	Dynamic Effects	●●	Shorter spans are less sensitive to wind effects.	●●	Shorter spans are less sensitive to wind effects.	●	Medium sensitivity to wind effects.	●●	Most sensitive to wind effects.
SNOW & ICE RESPONSE	Bridge closures	●●		●●		●●		●●	
	Monitoring/Deicing	●●		●●		●●		●●	
COMMUNITY CONSIDERATIONS	Appearance/Signature	●●		●●		●●		●●	
	Bike/Pedestrian Path	●●		●●		●●		●●	

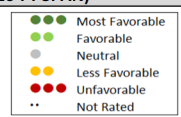




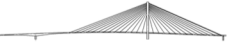


DECK CONFIGURATION		Single Deck/Single Path		Single Deck/Two Paths		Separate Decks/Single Path		Separate Decks/Two Paths	
EVALUATION CRITERIA		Rating	Notes	Rating	Notes	Rating	Notes	Rating	Notes
INITIAL COST	Main Span Structure	●	Highest floorbeam cost, but least number of ribs or cable planes.	●	Highest floorbeam cost, but least number of ribs or cable planes.	●	Least floorbeam costs, but requires more ribs or cable planes.	●	Least floorbeam costs, but requires more ribs or cable planes.
	Main Span Foundations	**		**		**		**	
	Overall	**		**		**		**	
HIGHWAY GEOMETRICS	Grade/Length	●●	Greater structure depth requires steeper or longer approach.	●●	Greater structure depth requires steeper or longer approach.	●●	Least floorbeam depth.	●●	Least floorbeam depth.
	Footprint	●	Smaller constructed footprint, but may require more takings.	●	Smaller constructed footprint, but may require more takings.	●●	Greatest flexibility for overlap with existing alignment.	●●	Greatest flexibility for overlap with existing alignment.
	Horizontal Tangent Length/Ramp Tie-Ins	**		●●●	Highway design constraints preclude two shared-use paths.	**		●●●	Highway design constraints preclude two shared-use paths.
MAINSpan FOOTINGS	Vessel Impact	**		**		**		**	
	Scour	**		**		**		**	
CONSTRUCTION	Phasing	●●	Not an option.	●●	Not an option.	●●●	Phase 1: 2 x 30-ft roadways	●●●	Phase 1: 2 x 27-ft roadways
	Duration	●●	Old bridge decommissioned later.	●●	Old bridge decommissioned later.	●●	Old bridge decommissioned soonest.	●●	Old bridge decommissioned soonest.
	Constructability	●●	Requires handling of large floorbeams, larger float-in weight and size.	●●	Requires handling of large floorbeams, larger float-in weight and size.	●●	More repetitive, smaller pieces.	●●	More repetitive, smaller pieces.
	Impact on Canal Traffic	**		**		**		**	
	Maintenance of Traffic	●	Staged tie-in to existing highway more difficult.	●	Staged tie-in to existing highway more difficult.	●●	Allows phased construction.	●●	Allows phased construction.
	Environmental Impact	●	Smaller constructed footprint, but may require more takings.	●	Smaller constructed footprint, but may require more takings.	●●	Greatest flexibility for overlap with existing alignment.	●●	Greatest flexibility for overlap with existing alignment.
STRUCTURAL REDUNDANCY	Fracture-Critical Members	**		**		**		**	
	Failure-Critical Members	●		●		●●●	Each structure can operate independently and carry two-way traffic and a path.	●●●	Each structure can operate independently and carry two-way traffic and a path.
INSPECTION & MAINTENANCE	Access	**		**		**		**	
	Frequency	**		**		**		**	
DURABILITY	Protection	**		**		**		**	
	Replacement	**		**		●●●	Each structure can operate independently and carry two-way traffic and a path.	●●●	Each structure can operate independently and carry two-way traffic and a path.
	Monitoring	**		**		**		**	
WIND RESPONSE	Structural Efficiency	**		**		**		**	
	Dynamic Effects	●●●	Better wind stability.	●●●	Better wind stability.	●●	Sensitive to deck spacing. Wind tunnel tests demonstrated good behavior.	●●	Sensitive to deck spacing. Wind tunnel tests demonstrated good behavior.
SNOW & ICE RESPONSE	Bridge closures	**		**		**		**	
	Monitoring/Deicing	**		**		**		**	
COMMUNITY CONSIDERATIONS	Appearance/Signature	**		**		**		**	
	Bike/Pedestrian Path	**		**		**		**	

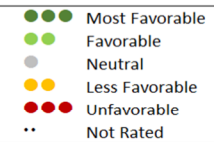
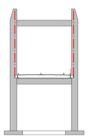
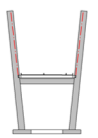
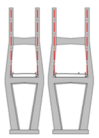
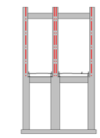
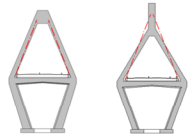
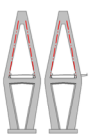

SINGLE BRIDGE DECK		Simple Span Floorbeam		Cantilever Floorbeam		Separate Pedestrian Level		Single Cable Plane	
EVALUATION CRITERIA		Rating	Notes	Rating	Notes	Rating	Notes	Rating	Notes
INITIAL COST	Main Span Structure	●	Largest floorbeam span.	●●	Reduced floorbeam span length.	●●	Additional cost for walkway support, transverse flyovers, and screens.	●●●	Requires torsionally stiff and deep deck girder to address eccentricity.
	Main Span Foundations	●		●		●●	Additional cost for walkway support and screens.	●	
	Overall	●●		●●		●●		●●	
HIGHWAY GEOMETRICS	Grade/Length	●●	Greater floorbeam depth requires steeper or longer approach.	●●	Greater floorbeam depth requires steeper or longer approach.	●●	Allows different grades for roadway and path.	●●	Deep structure increases approach length or grade.
	Footprint	●		●		●●	Smallest footprint.	●●	Closure strip/tower increases deck width.
	Horizontal Tangent Length/Ramp Tie-Ins	●●		●●		●●●	Highway design constraints preclude raised median path.	●●	
MAINSpan FOOTINGS	Vessel Impact	●●		●●		●●		●●	
	Scour	●●		●●		●●		●●	
CONSTRUCTION	Phasing	●●		●●		●●		●●	
	Duration	●●		●●		●●		●●	
	Constructability	●●	Requires handling of large floorbeams, larger float-in weight and size.	●●	Requires handling of large floorbeams, larger float-in weight and size.	●●		●●	
	Impact on Canal Traffic	●●		●●		●●		●●	
	Maintenance of Traffic	●●		●●		●●		●●	
Environmental Impact	●●		●●		●●		●●		
STRUCTURAL REDUNDANCY	Fracture-Critical Members	●●		●●		●●		●●	
	Failure-Critical Members	●●		●●		●●		●●	
INSPECTION & MAINTENANCE	Access	●●		●●		●●		●●	
	Frequency	●●		●●		●●		●●	
DURABILITY	Protection	●●		●●		●●		●●	
	Replacement	●●		●●		●●		●●	
	Monitoring	●●		●●		●●		●●	
WIND RESPONSE	Structural Efficiency	●●		●●		●●		●●	
	Dynamic Effects	●●		●●		●●		●●	
SNOW & ICE RESPONSE	Bridge closures	●●		●●		●●		●●	
	Monitoring/Deicing	●●		●●		●●		●●	
COMMUNITY CONSIDERATIONS	Appearance/Signature	●●		●●		●●		●●	
	Bike/Pedestrian Path	●		●●	Cable plane creates barrier effect.	●●	Path offset from traffic.	●	

SEPARATE BRIDGE DECKS		Simple Span Floorbeams		Cantilever Floorbeam		Twins With Link Slab	
EVALUATION CRITERIA		Rating	Notes	Rating	Notes	Rating	Notes
INITIAL COST	Main Span Structure	3 ●		4 ●●	Reduced floorbeam span.	●●	Reduced floorbeam span.
	Main Span Foundations	x ●●		x ●●		●●	
	Overall	x ●●		x ●●		●●	
HIGHWAY GEOMETRICS	Grade/Length	x ●●		x ●●		●●	
	Footprint	x ●●		x ●●		●●	
	Horizontal Tangent Length	x ●●		x ●●		●●	
MAINSpan FOOTINGS	Vessel Impact	x ●●		x ●●		●●	
	Scour	x ●●		x ●●		●●	
CONSTRUCTION	Phasing	4 ●●	2x30-ft roadways and 6-ft path in temporary configuration.	3 ●	2x26-ft roadways and 14-ft path in temporary configuration.	●●●	2x26-ft roadways but no path in temporary configuration.
	Duration	x ●●		x ●●		●●	
	Constructability	3 ●		3 ●		●●	Path adds another construction phase, durability of deck construction joints.
	Impact on Canal Traffic	x ●●		x ●●		●●	
	Maintenance of Traffic	x ●●		x ●●		●●	
	Environmental Impact	x ●●		x ●●		●●	
STRUCTURAL REDUNDANCY	Fracture-Critical Members	x ●●		x ●●		●●	
	Failure-Critical Members	x ●●		x ●●		●●	
INSPECTION & MAINTENANCE	Access	x ●●		x ●●		●●	
	Frequency	x ●●		x ●●		●●	
DURABILITY	Protection	3 ●		3 ●		●●	Complex behavior of link slab as it spans between twin superstructures.
	Replacement	x ●●		x ●●		●●	
	Monitoring	x ●●		x ●●		●●	
WIND RESPONSE	Structural Efficiency	x ●●		x ●●		●●	
	Dynamic Effects	3 ●		4 ●●	Improved wind response.	●	
SNOW & ICE RESPONSE	Bridge closures	x ●●		x ●●		●●	
	Monitoring/Deicing	x ●●		x ●●		●●	
COMMUNITY CONSIDERATIONS	Appearance/Signature	x ●●		x ●●		●●	
	Bike/Pedestrian Path	3 ●		4 ●●	Cable plane creates barrier effect.	●●	Path surrounded by traffic on both sides.

BRIDGE TYPE (700-FT SPAN)		Tied Arch	Tied Arch With Delta Frame	Truss	Two-Tower Cable Stayed	Single-Tower Cable Stayed	Box Girder
EVALUATION CRITERIA	Rating	Notes	Rating	Notes	Rating	Notes	Rating
INITIAL COST	Main Span Structure	●● Efficient off-site construction, least length of main span structure.	●● Efficient off-site construction, but added complexity from Delta frames.	● Slower construction.	●● Lower end of efficient span range for this type of structure.	●● Inefficient structural system.	●● Efficient and simple structural system.
	Main Span Foundations	●●	●●	●●	●●	●●	●● Heavy foundation.
	Overall	●●	●●	●●	●●	●●	●● Deeper superstructure requires longer or taller approaches.
HIGHWAY GEOMETRICS	Grade/Length	●● Least main span girder depth. Shortest main span creates more flexibility for curved approaches.	●● Least main span girder depth.	●● Least main span girder depth.	●● Limits or eliminates some approach bridge configurations, steepens ramp grades.	●● Limits or eliminates some approach bridge configurations, steepens ramp grades.	●● Highway design cannot accommodate extra approach structure length or grade required by increased main span girder depth.
	Footprint	●●	●●	●●	●●	●●	●●
	Horizontal Tangent Length	●● Main span only.	●● Main span only.	●● Main and side spans.	●● Main and side spans.	●● Main and side span.	●● Can accommodate moderate plan curvature.
MAINS PAN FOOTINGS	Vessel Impact	●●	●●	●●	●●	●●	●●
	Scour	●●	●●	●●	●●	●●	●●
CONSTRUCTION	Phasing	●●	●●	●●	●●	●●	●●
	Duration	●● Accelerated bridge construction with arch fabricated off-site and floated in.	●● Accelerated bridge construction with arch fabricated off-site and floated in.	●● Significant portion of structure erected by stick building.	●● Requires tower cranes which have limited operation window during wind.	●● Requires tower cranes which have limited operation window during wind.	●● Accelerated construction by working from two piers simultaneously. Cold weather impacts construction rates.
	Constructability	●● Complex and risky arch lifting operation on barge.	●● Arch floated in, Delta piers simplify lifting operation.	●● Stick building with floated in drop-in span.	●● Repetitive construction cycle, but requires careful cable force and geometry control, tower construction. Vulnerable to high wind events during construction.	●● Repetitive construction cycle, but requires careful cable force and geometry control, tower construction. Vulnerable to high wind events during construction.	●● Repetitive construction cycle.
	Impact on Canal Traffic	●● Single closure for each span lift.	●● Single closure for each span lift.	●● Barge operations near pier, one extended closure for drop-in lift.	●● Periodic, partial obstructions for segment lift from barge (approximately 40 lifts/bridge).	●● Periodic, partial obstructions for segment lift from barge (approximately 40 lifts/bridge).	●● None.
	Maintenance of Traffic	●●	●●	●●	●●	●●	●●
ENVIRONMENTAL IMPACT	Environmental Impact	●●	●●	●●	●●	●●	●●
	Fracture-Critical Members	●● Fracture critical elements (ties, hangers, floorbeams) designed for system or internal redundancy.	●● Fracture critical elements (ties, hangers, floorbeams) designed for system or internal redundancy.	●● Tension diagonals, tension chords designated as fracture-critical members.	●● Hangers, floorbeams - designed for system or internal redundancy.	●● Hangers, floorbeams - designed for system or internal redundancy.	●● No fracture critical members.
FAILURE CRITICAL MEMBERS	Failure-Critical Members	●● Improved rib stability due to network hanger arrangement.	●● Improved rib stability due to network hanger arrangement.	●● Any truss member.	●● Stiffening girder.	●● Stiffening girder.	●● Post-tensioning tendons.
	Access	●● Accessible tie girders and ribs, snoper for under-deck, cherry picker for cables.	●● Accessible tie girders and ribs, snoper for under-deck, cherry picker for cables.	●● Snoper and cherry picker.	●● Accessible towers, snoper for under-deck, rope access for cables	●● Accessible towers, snoper for under-deck, rope access for cables	●● Accessible box girder, snoper for under-deck, but cannot inspect internal tendons.
INSPECTION & MAINTENANCE	Frequency	●● Typical cycle.	●● Typical cycle.	●● Hands-on inspection of fracture-critical items at two-year intervals.	●● Typical cycle.	●● Typical cycle.	●● Typical cycle, fewest elements to inspect.
	Protection	●● Has vulnerable elements above deck. Metallized steel, partially prestressed precast deck panels.	●● Has vulnerable elements above deck. Metallized steel, partially prestressed precast deck panels.	●● Has vulnerable elements above deck. Metallized steel, concrete cover and corrosion resistant reinforcement.	●● Has vulnerable elements above deck. Metallized steel, partially prestressed precast deck panels.	●● Has vulnerable elements above deck. Metallized steel, partially prestressed precast deck panels.	●● Fewest exposed elements, deck fully prestressed longitudinally and transversely, concrete cover and corrosion resistant reinforcement.
DURABILITY	Replacement	●● Cables, deck overlay system, deck.	●● Cables, deck overlay system, deck.	●● Deck overlay system, deck.	●● Cables, deck overlay system, typically not designed for deck replacement.	●● Cables, deck overlay system, typically not designed for deck replacement.	●● Deck overlay system, deck replacement not possible.
	Monitoring	●● Cables.	●● Cables.	●● None required.	●● Cables.	●● Cables.	●● None required.
	Structural Efficiency	●●	●●	●●	●● Wind response during construction governs pylon and foundation design.	●● Poor wind performance (effectively twice the span length).	●● Negligible.
WIND RESPONSE	Dynamic Effects	●● Requires wind tunnel studies.	●● Requires wind tunnel studies.	●● Potential for truss member vibrations.	●● Requires wind tunnel studies for construction phases.	●● Requires wind tunnel studies.	●●
	Bridge closures	●● Uncommon.	●● Uncommon.	●● Uncommon.	●● During critical climate conditions.	●● During critical climate conditions.	●● Uncommon.
SNOW & ICE RESPONSE	Monitoring/Deicing	●● Ice drop from rib-bracing.	●● Ice drop from rib-bracing.	●● Ice drop from top chord bracing.	●● Ice drop from cables.	●● Ice drop from cables.	●● Uncommon.
	Appearance/Signature	●● Efficient, less height.	●● Echoes appearance of existing structure.	●● Dissimilarity to historic structure likely has adverse impact on Cape Cod Historic District.	●● Dissimilarity to historic structure likely has adverse impact on Cape Cod Historic District.	●● Dissimilarity to historic structure likely has adverse impact on Cape Cod Historic District.	●● Dissimilarity to historic structure likely has adverse impact on Cape Cod Historic District.
COMMUNITY CONSIDERATIONS	Bike/Pedestrian Path	●●	●●	●●	●●	●●	●●

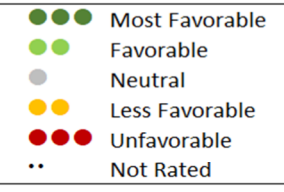
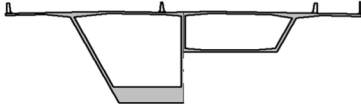

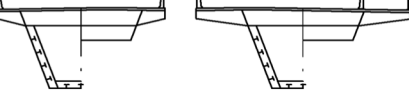


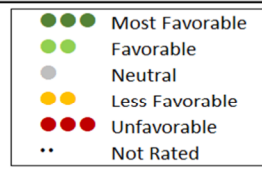
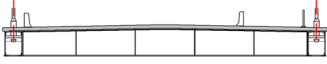




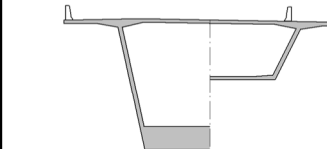
BRIDGE TYPE (820-FT SPAN)		Tied Arch	Tied Arch With Delta Frame	Truss	Two-Tower Cable Stayed	Single-Tower Cable Stayed	Box Girder	Suspension Bridge							
															
EVALUATION CRITERIA	Rating	Notes	Rating	Notes	Rating	Notes	Rating	Notes							
INITIAL COST	Main Span Structure	●●	Upper end of economical span range for this type of structure.	●●	Efficient off-site construction, but added complexity from Delta frames.	●●	Slow construction.	●●	Very efficient span range for this type of structure.	●●●	Inefficient structural system.	●	Efficient and simple structural system, but US record at this span range.	●●●	Not common/not economical for this span range.
	Main Span Foundations	●●		●●		●●		●●		●●		●●	Heavy foundation.	●●	
	Overall	●●		●●		●●		●●		●●		●●	Deeper superstructure requires longer or taller approaches.	●●	
HIGHWAY GEOMETRICS	Grade/Length	●●	Least main span girder depth. Shortest main span creates more flexibility for curved approaches.	●●	Least main span girder depth.	●●	Limits or eliminates some approach bridge configurations, steepens ramp grades.	●●	Limits or eliminates some approach bridge configurations, steepens ramp grades.	●●	Limits or eliminates some approach bridge configurations, steepens ramp grades.	●●●	Highway design cannot accommodate extra approach structure length or grade required by increased main span girder depth.	●●	Limits or eliminates some approach bridge configurations, steepens ramp grades.
	Footprint	●●	Main span only.	●●	Main span only.	●●	Main and side spans.	●●	Main and side spans.	●●	Main and side span.	●●	Can accommodate moderate plan curvature.	●●	Main and side spans.
	Horizontal Tangent Length	●●		●●		●●		●●		●●		●●		●●	
MAINSpan FOOTINGS	Vessel Impact	●●		●●		●●		●●		●●		●●		●●	
	Scour	●●		●●		●●		●●		●●		●●		●●	
CONSTRUCTION	Phasing	●●		●●		●●		●●		●●		●●		●●	
	Duration	●●●	Slow construction (stick building)	●●●	Accelerated bridge construction with arch fabricated off-site and floated in.	●●	Significant portion of structure erected by stick building.	●●	Requires tower cranes which have limited operation window during wind.	●●	Requires tower cranes which have limited operation window during wind.	●	Accelerated construction by working from two piers simultaneously, pier segments are time consuming.	●●	Slow construction (cable spinning)
	Constructability	●●	Record-span float-in or stick building, float-in requires fabrication yard on shore between existing bridges due to height of structure.	●●●	Vertical clearance restrictions and barging operations favor shorter span.	●●	Stick building with floated in drop-in span.	●●	Repetitive construction cycle, but requires careful cable force and geometry control, tower construction. Vulnerable to high wind events during construction.	●●	Repetitive construction cycle, but requires careful cable force and geometry control, tower construction. Vulnerable to high wind events during construction.	●	Record span for USA. Repetitive construction cycle.	●●	Uncommon type of structure.
	Impact on Canal Traffic	●●	Reduced channel width (~380 ft) due to falsework required during arch erection (~ 1 year).	●●	Barge operations near shore line, one 24 hr closure for drop-in lift.	●●	Barge operations near shore line, one 24 hr closure for drop-in lift.	●	Periodic, partial obstructions for segment lift from barge (approximately 40 lifts).	●	Periodic, partial obstructions for segment lift from barge (approximately 40 lifts).	●●●	None.	●	Periodic, partial obstructions for segment lift from barge (approximately 40 lifts).
	Maintenance of Traffic	●●		●●		●●		●●		●●		●●		●●	
ENVIRONMENTAL IMPACT	Environmental Impact	●●		●●		●●		●●		●●		●●		●●	
		●●		●●		●●		●●		●●		●●		●●	
STRUCTURAL REDUNDANCY	Fracture-Critical Members	●●	Fracture critical elements (ties, hangers, floorbeams) designed for system or internal redundancy.	●●	Fracture critical elements (ties, hangers, floorbeams) designed for system or internal redundancy.	●●●	Tension diagonals, tension chords designated as fracture-critical members.	●●	Hangers, floorbeams - designed for system or internal redundancy.	●●	Hangers, floorbeams - designed for system or internal redundancy.	●●●	No fracture critical members.	●●	Main cables. Floorbeams and hangers designed for system redundancy.
	Failure-Critical Members	●●	Arch ribs.	●●	Arch ribs.	●●	Any truss member.	●●	Stiffening girder.	●●	Stiffening girder.	●●	Post-tensioning tendons.	●	Saddles.
INSPECTION & MAINTENANCE	Access	●●	Accessible tie girders and ribs, snooper for under-deck, cherry picker for cables.	●●	Accessible tie girders and ribs, snooper for under-deck, cherry picker for cables.	●●	Snooper and cherry picker.	●	Accessible towers, snooper or traveler platform for under-deck, rope access for cables.	●	Accessible towers, snooper or traveler for under-deck, rope access for cables.	●●	Accessible box girder, snooper for under-deck, but cannot inspect internal tendons.	●●	Accessible tower, walkable main cable, snooper or traveler for under-deck.
	Frequency	●	Typical cycle.	●	Typical cycle.	●●	Hands-on inspection of fracture-critical items at two-year intervals.	●	Typical cycle.	●	Typical cycle.	●●●	Typical cycle, fewest inspection items.	●	Typical cycle.
DURABILITY	Protection	●	Has vulnerable elements above deck. Metallized steel, partially prestressed precast deck panels.	●	Has vulnerable elements above deck. Metallized steel, partially prestressed precast deck panels.	●	Has vulnerable elements above deck. Metallized steel, concrete cover and corrosion resistant reinforcement.	●	Has vulnerable elements above deck. Metallized steel, partially prestressed precast deck panels.	●	Has vulnerable elements above deck. Metallized steel, partially prestressed precast deck panels.	●●	Fewest exposed elements, deck fully prestressed longitudinally and transversely, concrete cover and corrosion resistant reinforcement.	●●	Has vulnerable elements above deck. Metallized steel, concrete cover and corrosion resistant reinforcement.
	Replacement	●	Cables, deck overlay system, deck.	●	Cables, deck overlay system, deck.	●	Deck overlay system, deck.	●	Cables, deck overlay system, typically not designed for deck replacement.	●	Cables, deck overlay system, typically not designed for deck replacement.	●●	Deck overlay system, deck replacement not possible.	●●	Cables, deck overlay system. Main cable is not replaceable.
	Monitoring	●	Cables.	●	Cables.	●	None required.	●	Cables.	●	Cables.	●	None required.	●	Cables.
WIND RESPONSE	Structural Efficiency	●		●		●		●●	Wind response during construction governs pylon and foundation design.	●●	Poor wind performance (effectively twice the span length)	●	Large depth for wind catching area - larger foundation loads.	●	
	Dynamic Effects	●●	Requires wind tunnel studies.	●●	Requires wind tunnel studies.	●	Potential for truss member vibrations.	●●	Requires wind tunnel studies.	●●	Requires wind tunnel studies.	●●	Negligible.	●●	Requires wind tunnel studies.
SNOW & ICE RESPONSE	Bridge closures	●	Uncommon.	●	Uncommon.	●	Uncommon.	●●	During critical climate conditions.	●●	During critical climate conditions.	●●	Uncommon.	●●	Uncommon.
	Monitoring/Deicing	●	Ice drop from rib-bracing.	●	Ice drop from rib-bracing.	●	Ice drop from top chord bracing.	●●	Ice drop from cables.	●●	Ice drop from cables.	●●	Uncommon.	●●	Uncommon.
COMMUNITY CONSIDERATIONS	Appearance/Signature	●●	Iconic.	●●●	Echoes appearance of existing structure.	●●	Dissimilarity to historic structure likely has adverse impact on Cape Cod Historic District.	●●	Dissimilarity to historic structure likely has adverse impact on Cape Cod Historic District.	●●	Dissimilarity to historic structure likely has adverse impact on Cape Cod Historic District.	●●	Dissimilarity to historic structure likely has adverse impact on Cape Cod Historic District.	●●	Dissimilarity to historic structure likely has adverse impact on Cape Cod Historic District.
	Bike/Pedestrian Path	●●		●●		●●		●●		●●		●●		●●	

CABLE STAYED BRIDGE TOWERS		Single H		Free-Standing H		Separate H's		Merged H's		Single A/Inverted Y		Separate A's		Merged A's	
															
EVALUATION CRITERIA		Rating	Notes	Rating	Notes	Rating	Notes	Rating	Notes	Rating	Notes	Rating	Notes	Rating	Notes
INITIAL COST	Main Span Structure	●●	Simplest tower shape.	●●	Inefficient structural system.	●	More complex formwork and bracing for inclined legs.	●●	Simple shape, efficient structure.	●	More complex formwork and bracing for inclined legs, inefficient structural system.	●	More complex formwork and bracing for inclined legs.	●	Most complex tower shape.
	Main Span Foundations	**		**		**		**		**		**		**	
	Overall	**		**		**		**		**		**		**	
HIGHWAY GEOMETRICS	Grade/Length	**		**		**		**		**		**		**	
	Footprint	**		**		**		**		**		**		**	
	Horizontal Tangent Length	**		**		**		**		**		**		**	
MAINSpan FOOTINGS	Vessel Impact	**		**		**		**		**		**		**	
	Scour	**		**		**		**		**		**		**	
CONSTRUCTION	Phasing	●●	Not an option.	●●	Not an option.	●●	Easily accommodates phased construction.	●	Possible, with extra considerations for tower construction.	●●	Not an option.	●●	Easily accommodates phased construction.	●	Possible, with extra considerations for tower construction.
	Duration	**		**		**		**		**		**		**	
	Constructability	●●	Simplest tower shape.	●		●		●●	Simple tower shape.	●●	Inclined tower legs.	●●	Inclined tower legs.	●●	Inclined and intersecting tower legs.
	Impact on Canal Traffic	**		**		**		**		**		**		**	
	Maintenance of Traffic	**		**		**		**		**		**		**	
	Environmental Impact	**		**		**		**		**		**		**	
STRUCTURAL REDUNDANCY	Fracture-Critical Members	**		**		**		**		**		**		**	
	Failure-Critical Members	**		**		**		**		**		**		**	
INSPECTION & MAINTENANCE	Access	**		**		**		**		**		**		**	
	Frequency	**		**		**		**		**		**		**	
DURABILITY	Protection	**		**		**		**		**		**		**	
	Replacement	**		**		**		**		**		**		**	
	Monitoring	**		**		**		**		**		**		**	
WIND RESPONSE	Structural Efficiency	●	Frame action.	●●	Flagpoles.	●	Frame action.	●●	Frame action.	●●	Truss action.	●●	Truss action.	●●	Truss action.
	Dynamic Effects	●●	Good flutter resistance due to great deck width.	●	Flexible tower legs.	●●	Wake effects, upstream/downstream wind flow interactions, poor deck flutter resistance.	●●	Wake effects, upstream/downstream wind flow interactions, poor deck flutter resistance.	●●	Best deck flutter resistance.	●●	Improved deck flutter resistance.	●●	Improved deck flutter resistance.
SNOW & ICE RESPONSE	Bridge closures	●	During critical climate conditions.	●●	During critical climate conditions.	●	During critical climate conditions.	●	During critical climate conditions.	●●	During critical climate conditions.	●●	During critical climate conditions.	●●	During critical climate conditions.
	Monitoring/Deicing	●	Ice drop from cables.	●●	Ice drop from cables.	●	Ice drop from cables.	●	Ice drop from cables.	●●	Ice drop from cables.	●●	Ice drop from cables.	●●	Ice drop from cables.
COMMUNITY CONSIDERATIONS	Appearance/Signature	●●	Simple.	●●	Less stable appearance.	●	Busy.	●	Simple.	●●	Odd proportions.	●●	Elegant.	●●	Iconic.
	Bike/Pedestrian Path	**		**		**		**		**		**		**	

CABLE-STAYED BRIDGE PYLONS		Single Cable Plane/Two Boxes		Single Cable Plane/Single Box		Two Cable Planes/Single Box		Three C. Planes/Single Box		Two C. Planes/Edge Girders	
EVALUATION CRITERIA		Rating	Notes	Rating	Notes	Rating	Notes	Rating	Notes	Rating	Notes
INITIAL COST	Main Span Structure	●	Greatest structure weight.	●	Slow deck construction.	●	Slow deck construction.	●	Slow deck construction.	●	Simplest tower.
	Main Span Foundations	**		**		**		**		**	
	Overall	**		**		**		**		**	
HIGHWAY GEOMETRICS	Grade/Length	**		**		**		**		**	
	Footprint	**		**		**		**		**	
	Horizontal Tangent Length	**		**		**		**		**	
MAINSpan FOOTINGS	Vessel Impact	**		**		**		**		**	
	Scour	**		**		**		**		**	
CONSTRUCTION	Phasing	●●	Not an option.	●●	Not an option.	●●	Not an option.	●●	Not an option.	●●	Not an option.
	Duration	**		**		**		**		**	
	Constructability	●	Precast concrete segments for deck.	●●	Cast-in-place concrete for deck.	●●	Cast-in-place concrete for deck.	●●●	Cast-in-place concrete for deck, interaction between three cable planes.	●●	Simplest deck system.
	Impact on Canal Traffic	**		**		**		**		**	
	Maintenance of Traffic	**		**		**		**		**	
	Environmental Impact	**		**		**		**		**	
STRUCTURAL REDUNDANCY	Fracture-Critical Members	**		**		**		**		**	
	Failure-Critical Members	**		**		**		**		**	
INSPECTION & MAINTENANCE	Access	**		**		**		**		**	
	Frequency	**		**		**		**		**	
DURABILITY	Protection	**		**		**		**		**	
	Replacement	**		**		**		**		**	
	Monitoring	**		**		**		**		**	
WIND RESPONSE	Structural Efficiency	●●	Flagpole.	●●	Flagpole.	●●	Tower and deck stabilize each other.	●●	Tower and deck stabilize each other.	●	More flexible deck, small torsional stiffness.
	Dynamic Effects	●	Flexible tower.	●	Flexible tower.	●●	Very stable system.	●●	Very stable system.	●	
SNOW & ICE RESPONSE	Bridge closures	●	During critical climate conditions.	●	During critical climate conditions.	●●	During critical climate conditions.	●●	During critical climate conditions.	●●	During critical climate conditions.
	Monitoring/Deicing	●	Ice drop from cables.	●	Ice drop from cables.	●●	Ice drop from cables.	●●	Ice drop from cables.	●●	Ice drop from cables.
COMMUNITY CONSIDERATIONS	Appearance/Signature	●●	Clean lines due to single cable plane.	●●	Single cable plane, closed box for deck.	●	Closed box for deck.	●●	Closed box for deck, busy with cables.	●●	Visible deck grillage.
	Bike/Pedestrian Path	**		**		**		**		**	

ARCH RIBS		Single/Vertical Ribs		Separate/Vertical Ribs		Merged/Vertical Ribs		Single/Freestanding		Single/Basket Handle		Separate/Basket Handle	
EVALUATION CRITERIA		Rating	Notes	Rating	Notes	Rating	Notes	Rating	Notes	Rating	Notes	Rating	Notes
INITIAL COST	Main Span Structure	●		●		●		●	Higher rib quantity and complexity, but no upper lateral bracing.	●		●●	Least rib bracing quantity.
	Main Span Foundations	●●		●●		●●		●●		●●		●●	
	Overall	●●		●●		●●		●●		●●		●●	
HIGHWAY GEOMETRICS	Grade/Length	●●		●●		●●		●●		●●		●●	
	Footprint	●●		●●		●●		●●		●●		●●	
	Horizontal Tangent Length	●●		●●		●●		●●		●●		●●	
MAINSPAN FOOTINGS	Vessel Impact	●●		●●		●●		●●		●●		●●	
	Scour	●●		●●		●●		●●		●●		●●	
CONSTRUCTION	Phasing	●●	Not an option.	●●	Easily accommodates phased construction.	●●	Not an option.	●●	Not an option.	●●	Not an option.	●	2x24-ft roadways but no path in temporary configuration.
	Duration	●●		●●		●●		●●		●●		●●	
	Constructability	●	Fewer, larger pieces to handle. More difficult to float in.	●●	Smaller, but more pieces to handle.	●●●	Three cable planes makes hanger forces and floorbeam moments difficult to control.	●●	Demanding geometry control for ribs.	●	More complex rib shoring.	●●	Smaller pieces to handle.
	Impact on Canal Traffic	●●		●●		●●		●●		●●		●●	
	Maintenance of Traffic	●●		●●		●●		●●		●●		●●	
	Environmental Impact	●●		●●		●●		●●		●●		●●	
STRUCTURAL REDUNDANCY	Fracture-Critical Members	●●		●●		●●		●●		●●		●●	
	Failure-Critical Members	●●		●●		●●		●●		●●		●●	
INSPECTION & MAINTENANCE	Access	●●		●●		●●		●●		●●		●●	
	Frequency	●●		●●		●●		●●		●●		●●	
DURABILITY	Protection	●●		●●		●●		●●		●●		●●	
	Replacement	●●		●●		●●		●●		●●		●●	
	Monitoring	●●		●●		●●		●●		●●		●●	
WIND RESPONSE	Structural Efficiency	●	Truss action, but high moment demands at portal frame.	●	Truss action, but high moment demands at portal frame.	●	Truss action, but high moment demands at portal frame.	●●●	Structural system not appropriate for this site.	●●	A-shape helps with wind resistance.	●●	A-shape helps with wind resistance.
	Dynamic Effects	●	More susceptible.	●	Potential for wake effects with closely spaced arch ribs.	●	More susceptible.	●●	Most susceptible.	●●	Less susceptible.	●●	Less susceptible.
SNOW & ICE RESPONSE	Bridge closures	●	Uncommon.	●	Uncommon.	●	Uncommon.	●	Uncommon.	●	Uncommon.	●	Uncommon.
	Monitoring/Deicing	●	Ice drop from rib bracing.	●	Ice drop from rib bracing.	●	Ice drop from rib bracing.	●●	No bracing members.	●●	Ice drop from ribs and rib bracing.	●●	Ice drop from ribs and rib bracing.
COMMUNITY CONSIDERATIONS	Appearance/Signature	●●	More rib bracing.	●●	More rib bracing.	●●	More rib bracing.	●●	Clean lines.	●●	Odd proportions.	●●	Less bracing.
	Bike/Pedestrian Path	●●		●●		●●		●●		●●		●●	

BOX GIRDERS		Single Concrete Box		Separate Concrete Boxes		Separate Steel Boxes	
							
EVALUATION CRITERIA		Rating	Notes	Rating	Notes	Rating	Notes
INITIAL COST	Main Span Structure	●●●	Very complex and heavy form traveler.	●●	Good repetition and rhythm.	●●●	Not competitive due to complex fabrication.
	Main Span Foundations	●●		●●		●●	
	Overall	●●		●●		●●	
HIGHWAY GEOMETRICS	Grade/Length	●●		●●●	Highway design constraints require minimizing structure depth.	●●	
	Footprint	●●		●●		●●	
	Horizontal Tangent Length	●●		●●		●●	
MAINSpan FOOTINGS	Vessel Impact	●●		●●		●●	
	Scour	●●		●●		●●	
CONSTRUCTION	Phasing	●●	Not an option.	●●	Easily accommodates phased construction.	●●	Easily accommodates phased construction.
	Duration	●●		●●		●●	
	Constructability	●●	Complex and heavy form traveler.	●●	Routine.	●●	Unusual system.
	Impact on Canal Traffic	●●		●●		●●	
	Maintenance of Traffic	●●		●●		●●	
	Environmental Impact	●●		●●		●●	
STRUCTURAL REDUNDANCY	Fracture-Critical Members	●●	No.	●●	No.	●●	Tension flanges and webs.
	Failure-Critical Members	●●		●●		●●	
INSPECTION & MAINTENANCE	Access	●●		●●		●●	
	Frequency	●●		●●		●●	
DURABILITY	Protection	●●		●●		●●	
	Replacement	●●		●●		●●	
	Monitoring	●●		●●		●●	
WIND RESPONSE	Structural Efficiency	●●		●●		●●	
	Dynamic Effects	●	Insensitive to dynamic effects.	●	Insensitive to dynamic effects.	●●	Sensitive to vortex-shedding induced oscillations.
SNOW & ICE RESPONSE	Bridge closures	●●		●●		●●	
	Monitoring/Deicing	●●		●●		●●	
COMMUNITY CONSIDERATIONS	Tensioned	●●	Understated elegance, closed box gives clean lines.	●●	Understated elegance, closed box gives clean lines.	●	Splices detract from otherwise elegant appearance.
	Bike/Pedestrian Path	●●		●●		●●	

DECK GIRDERS		Edge Steel Box (Arch)		Edge I-Girder W/Bracket (C.S.)		Edge I-Girder W/Fin (C.S.)		Edge Concrete Girders (C.S.)		Cable-Supported Box Girder		Self-Supporting Box Girder	
													
EVALUATION CRITERIA		Rating	Notes	Rating	Notes	Rating	Notes	Rating	Notes	Rating	Notes	Rating	Notes
INITIAL COST	Main Span Structure	x **		x **		x **		**		**		**	
	Main Span Foundations	x **		x **		x **		**		**		**	
	Overall	x **		x **		x **		**		**		**	
HIGHWAY GEOMETRICS	Grade/Length	**		**		**		**		●●●	Highway design constraints require minimizing structure depth.	●●●	Highway design constraints require minimizing structure depth.
	Footprint	x **		x **		x **		**		**		**	
	Horizontal Tangent Length	x **		x **		x **		**		**		**	
MAINSPAN FOOTINGS	Vessel Impact	x **		x **		x **		**		**		**	
	Scour	x **		x **		x **		**		**		**	
CONSTRUCTION	Phasing	x **		x **		x **		**		**		**	
	Duration	x **		x **		x **		**		**		**	
	Constructability	●●	Simple system, much repetition.	●●	Simple system, much repetition.	●	Simple system, much repetition, but fin plate connection to edge girder is challenging.	●●●	Precast or cast-in-place deck, difficult erection control.	●	Numerous heavy precast elements.	●●	Simplest system.
	Impact on Canal Traffic	x **		x **		x **		**		**		**	
	Maintenance of Traffic	x **		x **		x **		**		**		**	
Environmental Impact	x **		x **		x **		**		**		**		
STRUCTURAL REDUNDANCY	Fracture-Critical Members	●●	Edge boxes designed for internal redundancy.	●●	Floorbeam spacing < 12 feet or > 15 feet with redundancy girders.	●●	Floorbeam spacing < 12 feet or additional redundancy girders.	●●	None.	●●	None.	●●	None.
	Failure-Critical Members	●		●		●		●	Floorbeam post-tensioning tendons.	●●	Delta frames are critical component of system.	●	Longitudinal post-tensioning tendons.
INSPECTION & MAINTENANCE	Access	●●	Accessible edge box girder, snooper.	●●	Snooper or inspection traveler.	●●	Snooper or inspection traveler.	●●	Snooper or inspection traveler.	●●	Accessible box girders, snooper.	●●	Accessible box girders, snooper.
	Frequency	x **		x **		x **		**		**		**	
DURABILITY	Protection	●●	Cable anchorages inside box.	●	Cable anchorages below deck level.	●●	Cable anchorages at deck level.	●●	Cable anchorages underneath edge girders.	●●	Cable anchorages and Delta frames below deck.	●●	Very few exposed elements.
	Replacement	x **		x **		x **		**		**		**	
	Monitoring	x **		x **		x **		**		**		**	
WIND RESPONSE	Structural Efficiency	x **		x **		x **							
	Dynamic Effects	●●	Box edge girder is less susceptible.	●●	Relatively poor wind performance.	●●	Relatively poor wind performance.						
SNOW & ICE RESPONSE	Bridge closures	x **		x **		x **							
	Monitoring/Deicing	x **		x **		x **							
COMMUNITY CONSIDERATIONS	Appearance/Signature	●	Visible deck grillage and bracing, numerous splices.	●	Visible deck grillage, numerous splices.	●	Visible deck grillage.	●●	Cleaner lines, no splices.	●●	Closed box, cleaner lines.	●●	Closed box, cleaner lines.
	Bike/Pedestrian Path	x **		x **		x **		**		**		**	

APPROACHES		Steel Plate Girders	Concrete Bulb Tees	Single-Cell Concrete Box	Steel Tub Girders				
EVALUATION CRITERIA		Rating	Notes	Rating	Notes	Rating	Notes		
INITIAL COST	Main Span Structure	5 ●●●	Common bridge type, longer spans available.	2 ●●	Less efficient system, shorter spans (125-ft).	3 ●●●	Only economical in conjunction with segmental main box.	4 ●●	More complex fabrication, but cost competitive for straight highway alignment.
	Main Span Foundations	4 ●●		2 ●●	More foundations.	●	Heavy foundations.	4 ●●	
	Overall	x **		x **		**		x **	
HIGHWAY GEOMETRICS	Grade/Length	x **		x **		**		x **	
	Footprint	x **		x **		**		x **	
	Horizontal Tangent Length	x **		x **		**		x **	
MAINSpan FOOTINGS	Vessel Impact	x **		x **		**		x **	
	Scour	x **		x **		**		x **	
CONSTRUCTION	Phasing	4 ●●	Can be easily accommodated.	4 ●●	Can be easily accommodated.	●●	With two boxes.	4 ●●	Can be easily accommodated.
	Duration	x **		x **		**		x **	
	Constructability	4 ●●	Typical system.	1 ●●●	Inappropriate for long spans. Using spliced girders introduces complex construction logistics.	●●	Requires complex erection gantry or falsework.	1 ●●●	Difficult crane access and high pick weight.
	Impact on Canal Traffic	x **		x **		**		x **	
	Maintenance of Traffic	x **		x **		**		x **	
	Environmental Impact	x **		x **		**		x **	
STRUCTURAL REDUNDANCY	Fracture-Critical Members	x **		x **		**		x **	
	Failure-Critical Members	x **		x **		**		x **	
INSPECTION & MAINTENANCE	Access	x **		x **		**		x **	
	Frequency	x **		x **		**		x **	
DURABILITY	Protection	4 ●●	Weathering steel, deck protection system.	4 ●●	Fully prestressed girders, deck protection system.	●●	Deck prestressed in two directions, deck protection system.	4 ●●	Weathering steel, deck protection system.
	Replacement	4 ●●	Deck is replaceable.	4 ●●	Deck is replaceable.	●	Sacrificial deck thickness, deck not replaceable.	4 ●●	Deck is replaceable.
	Monitoring	x **		x **		**		x **	
WIND RESPONSE	Structural Efficiency	x **		x **		**		x **	
	Dynamic Effects	x **		x **		**		x **	
SNOW & ICE RESPONSE	Bridge closures	x **		x **		**		x **	
	Monitoring/Deicing	x **		x **		**		x **	
COMMUNITY CONSIDERATIONS	Appearance/Signature	3 ●	Utilitarian.	3 ●	Utilitarian.	●●	Clean lines.	4 ●●	Clean lines.
	Bike/Pedestrian Path	x **		x **		**		x **	

# Appendix D Cape Cod Bridges Program Interchange Approach Concepts



Alt ID	Name	Alternative Description or Sub-Alternative Modification	Status	Reason for Non-Active Status	Date of Initial Development	Date of Modification	Date of Pause for advancement	Date of Elimination
<b>Bourne Mainlines</b>								
M-BF-1	Fully Offline East 1	Shifts Route 28 east of the existing bridge. The proposed southbound bridge is placed at a minimum ten feet away from the east edge of the existing bridge. Alignment allows for the proposed northbound and southbound bridges to be built before the existing bridge needs to be demolished. On the south side, the roadway follows reversing curves separated by a tangent to tie into the existing mainline as quickly as possible. On the north side, the roadway ties into existing curvature using a compound curve.	Not Being Developed Further	alignment is not advantageous compared to 1.1, and could be reincorporated if needed in preliminary design.	December 2020	April 2021	Oct-21	
M-BF-1.1	Fully Offline East 1.1	Shifts Route 28 east of the existing bridge and matches the M-BF-1 alignment everywhere but on the south side. On the south side, the reverse curvature of M-BF-1 is straightened out, moving the tie in with existing further south and increasing impacts adjacent the existing roadway on the east.	Active		December 2020	April 2021		
M-BP-1	Partially Offline East 1	Shifts Route 28 east of the existing bridge. The proposed southbound bridge is placed in alignment with the existing bridge. Alignment allows for the proposed northbound bridge to be built prior to demolishing the existing bridge, but the existing bridge would need to be demolished first to build the proposed southbound bridge. The northern and southern tie ins are similar to the ties in associated with the M-BF-1.1 alignment.	Active		December 2020			
M-BP-2	Partially Offline West 1	Shifts Route 28 west of the existing bridge. The proposed northbound bridge is placed in alignment with the existing bridge. Alignment allows for the proposed southbound bridge to be built prior to demolishing the existing bridge, but the existing bridge would need to be demolished first to build the proposed northbound bridge. The northern and southern tie ins are similar to the ties in associated with the M-BF-1.1 alignment.	Active		July 2021			
M-BF-Outboard	Partially Offline West 1	Shifts both Route 28 EB and WB west of the existing bridge.	Active		May 2022			
M-BF-Bifurcated	Partially Offline West 1	Splits NB barrel to the east (inboard) and the SB barrel to the west (outboard) so construction is able to occur around the existing bridge and is considered fully offline	Active		June 2022			

Alt ID	Name	Alternative Description or Sub-Alternative Modification	Status	Reason for Non-Active Status	Date of Initial Development	Date of Modification	Date of Pause for advancement	Date of Elimination
<b>Bourne North Interchanges</b>								
BN-1	Belmont Circle T	Reconfiguration of Belmont Circle into a T intersection	Not Being Developed Further	due to traffic analysis poor ops - replaced with 1.2	February 2021		October 2021	November 2021
BN-1.1	Belmont Circle Florida T	Reconfiguration of Belmont Circle into a Florida T intersection	Not Being Developed Further	due to traffic analysis poor ops - replaced with 1.2	July 2021		October 2021	November 2022
BN-1.2	Main St & Scenic Highway Alginment - Belmont Circle	Reconfiguration of Belmont Circle to the South Side of the circle so that Main St to Rt 6 (heavier movement) can be the through movement	Active		October 2021			
BN-2	Belmont Circle 4 Legged	Reconfiguration of Belmont Circle into a 4 legged intersection	Active		April 2020	October 2021		
BN-2.1	Belmont Circle Roundabout	4 legged intersection with roundabout and bypass lanes	Active		October 2021	October 2021		
BN-3	Realigned Route 6	Realignment of Route 6 with Buzzards bay via old bridge approach roadway	Active		April 2020	October 2021	January 2022	
BN-3.1	Realigned Route 6 with Florida T	Realignment of Route 6 with at-grade Florida T intersection with ramps	Not Being Developed Further	This intersection option requires realignment of Scenic Highway through the businesses on the Bourne Bridge Approach roadway. The impacts to local businesses and residential houses on the east side of the bridge are severe and this option is seen as undesirable.	July 2021			December 2021
BN-4	Northbound Diamond	Half diamond (NB)	Not Being Developed Further	NB off-ramp grade over 7%	April 2020			February 2021
BN-5	NB Frontage Road	NB on-ramp to frontage road	Not Being Developed Further	connection from 6 WB to existing loop ramp option more desirable (BN-6.1)	April 2020			September 2021
BN-6	NB Separated Off Ramp	NB on-ramp separated from Off ramp	Not Being Developed Further	connection from 6 WB to existing loop ramp option more desirable (BN-6.1)	April 2020			September 2021
BN-6.1	NB Separated Off Ramp	NB on-ramp to connect to existing outer loop on ramp	Active		September 2021			
BN-7	Diverging Diamond	Diverging diamond interchange at Route 6 (Scenic Hwy)	Not Being Developed Further	NB off-ramp and SB on-ramp grade over 7%	April 2020			February 2021
BN-8	Big Diverging Diamond	Diverging diamond with split Route 6 (Scenic Hwy)	Not Being Developed Further	NB off-ramp and SB on-ramp grade over 7%	April 2020			February 2021
BN-9	Underpass	Underpass at Belmont Circle	Not Being Developed Further	utiltiy and grounder issues preculde this alaternative	April 2020			September 2021

PRE-DECISIONAL AND DELIBERATIVE

Alt ID	Name	Alternative Description or Sub-Alternative Modification	Status	Reason for Non-Active Status	Date of Initial Development	Date of Modification	Date of Pause for advancement	Date of Elimination
BN-10	Overpass	Overpass at Belmont Circle	Active		May 2021			
BN-10.1	Overpass with WB to NB slip lane	Overpass at Belmont Circle Belmont Circle intersection shifted WB Removed Route 6 WB to NB ramp, replaced with slip lane at intersection	Not Being Developed Further	too much fill required, is undesirable compared to BN-10	September 2021	October 2021		
BN-11	Continuous Flow Green T	Continuous flow intersection on Scenic Hwy with NB on-ramp	Not Being Developed Further	new loop ramp option more desirable (BN-11.1)	April 2020	October 2021		September 2021
BN-11.1	Continuous Flow Green T	Continuous flow intersection on Scenic Hwy with NB on-ramp to existing outer loop on ramp	Not Being Developed Further	-other design alternative carry same movements in simpler alignments. Retained for possible inclusion of some of the elements in this alternative for others	September 2021		October 2021	
BN-12	Belmont Circle T with roundabout	Belmont Circle replaced with roundabout, NB on-ramp merges or stays separated from off ramp	Incorporated Elsewhere	roundabout moved to BN 2.1	July 2021	October 2021		
BN-13	Modified Diamond 1	SB off ramp to Rt 6 and Rt 6 to NB on ramp direct connection, bypassing Belmont Circle	Not Being Developed Further	connection from 6 WB to existing loop ramp option more desirable (BN-13.1)	July 2021			September 2021
BN-13.1	Modified Diamond 1	SB off ramp to Rt 6 and Rt 6 to NB on ramp direct connection, bypassing Belmont Circle NB on-ramp to connect to existing outer loop on ramp	Active		September 2021			
BN-14	Modified Diamond 2 - Option 1	SB off ramp to Rt 6 and Rt 6 to NB on ramp direct connection, bypassing Belmont Circle Realigned neighborhood access to High Ridge Drive and new campground entrance	Not Being Developed Further	connection from 6 WB to existing loop ramp option more desirable (BN-14.2)	July 2021			September 2021
BN-14	Modified Diamond 2 - Option 2	SB off ramp to Rt 6 and Rt 6 to NB on ramp direct connection, bypassing Belmont Circle Realigned neighborhood access to Desert Drive and new campground entrance	Not Being Developed Further	connection from 6 WB to existing loop ramp option more desirable (BN-14.3)	July 2021			September 2021
BN-14.1	Modified Diamond 3	SB off ramp to Rt 6 and Rt 6 to NB on ramp direct connection, bypassing Belmont Circle	Not Being Developed Further	connection from 6 WB to existing loop ramp option more desirable (BN-14.4)	July 2021			September 2021
BN-14.2	Modified Diamond 2 - Option 1	SB off ramp to Rt 6 and Rt 6 to NB on ramp direct connection, bypassing Belmont Circle NB on-ramp to connect to existing outer loop on ramp Realigned neighborhood access to High Ridge Drive and new campground entrance	Not Being Developed Further	Alternative required closure of Nightingale Road at Scenic Highway. Reconnection to maintain residential access required long and roundabout route around the cranberry bog and new full signalized intersection on Scenic Highway. Option was removed as BN-14.4b accomplished the same connections.	September 2021			January 2022
BN-14.3	Modified Diamond 2 - Option 2	SB off ramp to Rt 6 and Rt 6 to NB on ramp direct connection, bypassing Belmont Circle NB on-ramp to connect to existing outer loop on ramp Realigned neighborhood access to Desert Drive and new campground entrance	Incorporated Elsewhere	- provided as sub alternative to 14.2	September 2021			
BN-14.4	Modified Diamond 3	SB off ramp to Rt 6 and Rt 6 to NB on ramp direct connection, bypassing Belmont Circle NB on-ramp to connect to existing outer loop on ramp	Incorporated Elsewhere	- provided as sub alternative to 14.2	September 2021			
BN-14.4a	Modified Diamond 3 With at Grade Intersection at Nightingale	SB off ramp to Rt 6 and Rt 6 to NB on ramp at intersection at Nightingale Road, bypassing Belmont Circle NB on-ramp to connect to existing outer loop on ramp	Incorporated Elsewhere	- provided as sub alternative to 14.2	October 2021			
BN-14.4b	Modified Diamond 3 With at Grade Intersection at Nightingale	SB off ramp to Rt 6 and Rt 6 to NB on ramp at intersection at Nightingale Road, bypassing Belmont Circle NB on-ramp to connect to existing outer loop on ramp with structure over Nightingale Road	Active	- provided as sub alternative to 14.2	October 2021			

Alt ID	Name	Alternative Description or Sub-Alternative Modification	Status	Reason for Non-Active Status	Date of Initial Development	Date of Modification	Date of Pause for advancement	Date of Elimination
<b>Bourne South Interchanges</b>								
BS-1	At-Grade Intersection	At-grade 4 legged intersection	Not Being Developed Further	traffic analysis showed 3 left turn lanes on SB 28 - direction from massdot to not continue and move intersection to BS-9	Feb 2021			Sep-21
BS-2	Diamond	Diamond interchange	Active		April 2020			
BS-2.2	Diamond	Diamond interchange with Single Point Urban Interchange	Active		April 2020			
BS-3	Diverging Diamond	Diverging diamond interchange on Sandwich Rd/Trowbridge	Incorporated Elsewhere	provided as sub alternative to BS-2	April 2020		October 2021	February 2021
BS-4	Semi-Direct	Variation of Planning Study Alternative	Not Being Developed Further	SB Off ramp is expected to have impacts to the Police Barracks. Expectation for increased wayfinding signs necessary to clarify direct connection directions.	May 2021	October 2021		December 2021
BS-4.1	Modified Semi-Direct	Modified Study Alt with Rdbt.	Not Being Developed Further	no advantage with roundabout - design abandoned	April 2020			August 2021
BS-5	Modified No Cut Through	Partial cloverleaf with discontinued through route	Not Being Developed Further	No Trowbridge/Sandwich through for EB or WB was not considered viable	April 2020			February 2021
BS-6	Partial Clover 1	Partial cloverleaf with loops in SW & SE quadrants	Active		February 2021			
BS-6.1	Partial Clover 1	Partial cloverleaf with loops in SW & SE quadrants Peanut roundabout in NW quadrant	Active		January 2022			
BS-7	Partial Clover 2	Partial cloverleaf with loops in SE quadrants	Not Being Developed Further	Alternatives requires very steep ramp profile grades. Elimination of Veteran's Road negatively impacts local traffic movements.	February 2021		October 2021	
BS-8	Split with Direct Connects	Trowbridge Rd E/W split with direct connects between	Not Being Developed Further	Alternative has poor merge/weave distances and excessive abutter impacts. Safety concerns with the proposed NB On-Ramp access through jug-handle.	February 2021		October 2021	
BS-9	Bourne Rotary Replaced with Roundabout	Bourne rotary replaced with roundabout and no Trowbridge Road through	Active		July 2021			
BS-9.1	Bourne Rotary Replaced with Roundabout	Bourne rotary replaced with roundabout and no Trowbridge Road through	Active		February 2022			
BS-10	Partial Clover 3	Partial cloverleaf with loops in SW & SE quadrants	Not Being Developed Further	Concerns about maintaining all the structures proposed in the hybrid alternatives "spaghetti ramps".	July 2021		October 2021	
BS-10.1	Partial Clover 3 Modified	Partial cloverleaf with loops in SW & SE quadrants. Differs from BS-10 with Sandwich Road cul-de-sac	Not Being Developed Further	Creates cul-de-sac of residential Sandwich Road Underpass. Concerns about maintaining all the structures proposed in the hybrid alternatives "spaghetti ramps".	July 2021		October 2021	
BS-11	Partial Clover 4	Partial cloverleaf with loops in SE quadrant	Not Being Developed Further	Requires a 50' tall structure over the mainline roadways. Concern about required maintenance on all hybrid options.	July 2021			October 2021
BS-12	Partial Clover 5	Partial cloverleaf with loops in SE quadrant	Incorporated Elsewhere	Alternative was combined with BS-6	August 2021		October 2021	

Alt ID	Name	Alternative Description or Sub-Alternative Modification	Status	Reason Alternative Is Not Being Developed Further	Date of Initial Development	Date of Modification	Date Development Held
<b>Sagamore Mainlines</b>							
M-SF-1	Fully Offline West 1	Shifts the new Route 6 alignment west of the Existing Bridge. The proposed northbound bridge is placed ten feet off the northern abutment, and the southern end of the bridge is angled west to improve horizontal geometry.	Not Being Developed Further	This alignment is similar to M-SF-4, but is not shifted far enough to the west to allow for bicycle and pedestrian improvements along State Road. In addition, the construction of the new bridge over Scenic Highway would likely need a temporary bridge that would be in the footprint of M-SF-4. For these reasons, M-SF-1 is not being developed further.	February 2021		May 2022 (Mainline Matrix Development Process)
M-SF-2	Fully Offline West 2 - Parallel	Shifts the new Route 6 alignment west of the Existing Bridge and runs parallel to the existing bridge over the canal.	Not Being Developed Further	This alignment is similar to M-SF-1 but introduces an S curve scenario (with tangent between the curves) on the south side of the bridge. The objective with this alignment was to lessen impacts to private property on the west side of the bridge. This alternative still requires demolition of the building near Market Basket and a significant reduction in property impacts was not realized. For this reason and due to the S curve geometry on the south side of the canal, this alternative is not being developed further.	February 2021		December 2, 2021 (FHWA & MassDOT Mtg)
M-SF-3	Fully Offline West 3	Shifts the new Route 6 alignment further west than SF-1 to avoid impacts to the Marconi Street properties.	Not Being Developed Further	This alignment is similar to M-SF-4, but is not shifted far enough to the west to allow for bicycle and pedestrian improvements along State Road. In addition, the construction of the new bridge over Scenic Highway would likely need a temporary bridge that would be in the footprint of M-SF-4. For these reasons, M-SF-3 is not being developed further.	March 2021 (After MassDOT Mtg)		May 2022 (Mainline Matrix Development Process)
M-SF-4	Fully Offline West 4	Variation of M-SF-3. Also shifts Route 6 / 3 to the west, north of the canal.	Active		August 2021		
M-SF-5	Fully Offline East 1	Shifts the new Route 6 alignment to the east of the existing canal bridge.	Active		May 2022		
M-SF-6	Split Alignment	This alternative places the WB(NB) barrel east of the existing bridge and the EB(SB) barrel west of the existing bridge.	Active		June 2022		
M-SP-1	Partially Offline West 1	Shifts the new Route 6 alignment west of the existing bridge. The proposed southbound bridge is placed ten feet off the northern abutment, and the southern end of the bridge is angled west to improve horizontal geometry. The northbound bridge will be constructed within the approximate footprint of the existing bridge.	Active		February 2020		
M-SP-1.1	Partially Offline West 1.1	Similar to SP-1, but provides full horizontal curve lengths north of the canal.	Not Being Developed Further	Providing full curve lengths north of the canal with this alignment would have impacted the Canalside Apartments. In addition, the existing curves on Route 3 that these curves would tie into would then become substandard in length, requiring more alignment revisions north of the project limit to correct deficiencies.	February 2021		March 2021 (Pre MassDOT Mtg)

Alt ID	Name	Alternative Description or Sub-Alternative Modification	Status	Reason Alternative Is Not Being Developed Further	Date of Initial Development	Date of Modification	Date Development Held
M-SP-1.2	Partially Offline West 1.2	Similar to SP-1 but includes reverse curve on south approach.	Not Being Developed Further	This alternative has substandard geometry on the south side of the canal. The reverse curves provided with this alternative do not allow for proper superelevation transition, are short in length (390 - 734 feet), and only provide 50 mph SSD.	July 2021		Sept 9, 2021 (During MassDOT Mtg)
M-SP-2	Partially Offline West 2	Similar to SP-1 but angles further away from the existing bridge on the south side of the canal to try to tie into Route 3 sooner.	Not Being Developed Further	Scenic highway bridge replacement was still required due to horizontal and vertical shifts. In addition, due to the placement of the alignment, construction staging for the bridge over scenic highway would be complicated and a temporary bridge would likely be needed.	February 2021		March 2021 (Pre MassDOT Mtg)
M-SP-3	Partially Offline East 1	Shifts the new Route 6 alignment east of the existing bridge. The proposed northbound bridge is placed ten feet off the northern abutment and runs parallel to the existing bridge. The southbound bridge will be constructed within the approximate footprint of the existing bridge.	Active		April 2021		
<b>Sagamore North Interchanges</b>							
SN-1A (formerly SN-1)	Existing Configuration	Maintains existing ramp configurations	Active		April 2020		
SN-1B	Route 6 EB On Ramp - Existing Configuration	Maintains the idea of the existing geometry for the Route 6 EB On Ramp. Maintains free flow ramp condition and S curve geometry.	Active		February 2022		
SN-1C	Route 3 SB Off Ramp with M-SF-3 Mainline Alignment	Maintains existing ramp geometry with adjustments to meet the SF-3 mainline alignment.	Not Being Developed Further	This alternative was eliminated when the M-SF-3 Mainline Alignment was eliminated. Note, the geometry for the Route 3 SB off ramp is the same as the geometry for SN-8D. The difference is the mainline that is being used for these alternatives.	February 2022		May 2022 (Mainline Matrix Development Process)
SN-2	NB Off-Ramp to Scenic Hwy	NB to EB movement to signalized T intersection with Meetinghouse Lane	Not Being Developed Further	Likely operational issues (replaced with SN-3)	February 2021		March 2021 (After MassDOT Mtg)
SN-3A (formerly SN-3)	NB Off-Ramp to State Road	NB to State Rd/Meetinghouse Lane movement to signalized T intersection with State Road. NB to WB movement remains on loop ramp.	Not Being Developed Further	This alternative is similar to SN-8A except that it assumes the M-SF-3 mainline alignment. This alternative was eliminated with the elimination of the M-SF-3 mainline alignment.	March 2021		May 2022 (Mainline Matrix Development Process)
SN-4A (formerly SN-4)	NB Off-Ramp to State Road	Single NB exit to roundabout at State Road.	Active		July 2021		
SN-4.1	NB Off-Ramp to State Road	Single NB exit to roundabout at State Road. Roundabout at State Road / Scenic Highway / Meetinghouse Lane intersection.	Not Being Developed Further	This alternative is similar to SN-4A except that it provides a roundabout (verses signalized intersection) at the Canal St/Meetinghouse Ln/State Rd/Scenic Highway intersection. This alternative will have significant impacts on the McDonald's property and will likely impact drive through operations. For this reason, this alternative is no longer being developed.	July 2021		December 2, 2021 (FHWA & MassDOT Mtg)

Alt ID	Name	Alternative Description or Sub-Alternative Modification	Status	Reason Alternative Is Not Being Developed Further	Date of Initial Development	Date of Modification	Date Development Held
SN-5	NB Off-Ramp to State Road	NB free flow movement to peanut roundabout at State Road / Scenic Highway / Meetinghouse Lane intersection. No direct left turn to State Road NB (U-turn within peanut roundabout)	Not Being Developed Further	The elimination of left turns onto State Road has a negative impacts at the Meetinghouse Lane/Canal St/Scenic Highway intersection. This alternative would require a double lane peanut roundabout which would increase impacts to McDonalds and Dunkin Donuts at this intersection. For these reasons, this alternative is no longer being developed.	July 2021		December 2, 2021 (FHWA & MassDOT Mtg)
SN-5A (formerly SN-7)	Route 3/ 6 EB On-Ramp Alteration to Diamond On-Ramp	Moves both Route 3 / 6 EB on-ramps from the Church Lane intersection to a signalized intersection at the existing Route 3 SB off-ramp location.	Not Being Developed Further	Eliminated from the alternatives list due to excessive grades for the Route 6 EB On Ramp.	July 2021		
SN-6A (formerly SN-6)	Route 3/ 6 EB On-Ramp Alteration	Brings traffic on Scenic Highway EB destined for Route 6 On-Ramp to signalized intersection at Church Lane. Removes existing free flow on-ramp. Maintains S curve on ramp.	Active		July 2021		
SN-8A (formerly SN-8)	SN-3 & SN-5 Hybrid with revised Route 3 SB On-Ramp	Includes bike/ped accommodations along State Rd. Utilizes M-SF-4 mainline to provide additional space for reconstructed loop ramp with wider State Rd. Includes new signalized intersection at State Rd.	Active		August 2021		
SN-8B	Simple, Free Flow Route 6 EB On Ramp with Roundabout at Church Lane	Assumes a roundabout at Church Lane. Maintains the existing free flow ramp for Scenic Highway to Route 6 EB traffic. Provides a long tangent and simple curve for the ramp geometry.	Active		February 2022		
SN-8C	Simple, Free Flow Route 6 EB On Ramp with signal at Church Lane	Assumes a signal at Church Lane. Maintains the existing free flow ramp for Scenic Highway to Route 6 EB traffic. Provides a long tangent and simple curve for the ramp geometry.	Active/Design Development		February 2022		
SN-8D	Route 3 SB Off Ramp with SF-4 Mainline Alignment	Maintains existing ramp geometry but is shifted to the west to accommodate the M-SF-4 Mainline Alignment.	Active		February 2022		
SN-8E	Simple, Channelized Right Route 6 EB On Ramp with signal at Church Lane	Assumes a signal at Church Lane. Creates a channelized right turn for Scenic Highway EB to Route 6 EB traffic. Provides a long tangent and simple curve for the ramp geometry.	Active/Design Development		April 2022		
Scenic Highway - Option 1	Three signalized intersections along Scenic Highway.	Provides signalized intersections at Church Lane, the Route 3 SB Off Ramp, and State Road.	Active/Design Development		February 2022		
Scenic Highway - Option 2	Two signalized intersections along Scenic Highway and a Peanut Roundabout at the State Road Intersection	Provides signalized intersections at Church Lane and the Route 3 SB Off Ramp. Provides a peanut roundabout at State Road.	Active/Design Development		February 2022		
Scenic Highway - Option 3	Three Roundabouts along Scenic Highway.	Provides roundabouts at Church Lane, the Route 3 SB Off Ramp, and State Road.	Active		February 2022		
<b>Sagamore South Interchanges</b>							
SS-1	Existing Configuration: Partial Diamond with Cranberry Hwy Extension	Maintains existing ramp configurations; Adds Cranberry Highway Extension to Connect to Mid Cape Connector via the Market Basket Driveway	Active		April 2020		
SS-1.1	Existing Configuration: Partial Diamond	Same as SS-1 but does not include the Cranberry Highway Extension	Active		September 2021		

PRE-DECISIONAL AND DELIBERATIVE

Alt ID	Name	Alternative Description or Sub-Alternative Modification	Status	Reason Alternative Is Not Being Developed Further	Date of Initial Development	Date of Modification	Date Development Held
SS-2	Existing Configuration: Partial Diamond with South Cranberry Hwy Extension	Maintains existing ramp configurations; Adds Cranberry Highway Extension to Connect to Mid Cape Connector south of Market Basket	Not Being Developed Further	Development held due to significant residential impacts to the Marconi Street neighborhood and steep (7% +/-) grades for the Route 6 WB on and off ramps.	April 2020		December 2, 2021 (FHWA & MassDOT Mtg)
SS-3	Route 6 WB On Ramp Flyover	Flyover from Mid-Cape Connector to Route 6 WB with north Cranberry Hwy Extension	Active		April 2020		
SS-3.1	WB On and Off Ramp Underpass to Mid Cape Connector w/ Cranberry Highway Extension	Fly under from Mid-Cape Connector to Route 6 WB, Fly under from Route 6 WB to Mid-Cape Connector with north Cranberry Hwy Extension	Active		August 2021		
SS-3.1A	Route 6 WB On Ramp Under Route 6	Relocated the Route 6 WB On ramp to come off of Mid Cape Connector. All other ramps and generally where the existing ramps are.	Active		April 2020		
SS-3.2	WB On and Off Ramp Underpass	Same as SS-3.1 but does not include the Cranberry Highway Extension	Active		September 2021		
SS-4	Utility Corridor off Sandwich Road	Route 6 WB On and Off ramps using utility corridor (Study Alt); Access is off of Sandwich Road (Route 6A)	Not Being Developed Further	Not being developed further due to environmental impacts to endangered species (box turtle).	February 2021		December 2, 2021 (FHWA & MassDOT Mtg)
SS-4.1	Utility Corridor off Cranberry Highway	Route 6 WB On and Off ramps using utility corridor (Study Alt); Access is off Cranberry Highway	Not Being Developed Further	Development held due to steep grade (8% for 1,000 ft) and impacts to Protect Article 97/4f Land (state forest).	March 2021		Sept 9, 2021 (During MassDOT Mtg)
SS-5	Roundabout Interchange at Utility Corridor	West side frontage road to roundabout/peanut interchange at utility corridor	Not Being Developed Further	Development held due to impacts to JBCC and Protected Article 97 Land	April 2020		Feb 2021
SS-6	Cranberry Highway Roundabouts	Evaluated Roundabouts along Cranberry Highway and extending the on ramp along Cranberry Highway to try to lessen grades for the Route 6 on ramp near the Christmas Tree Shop.	Not Being Developed Further	Development held due to steep grades still found on the ramp and significant impacts with the roundabouts to adjacent properties.	February 2021		March 2021 (Pre MassDOT Mtg)
SS-7	Full Diamond	Full diamond with north Cranberry Hwy Extension	Not Being Developed Further	Development held due to NB on and off and SB off ramps being too steep	April 2020		Feb 2021
SS-8	Utility Corridor Partial Roundabout	Study Alt with NB and SB connections using roundabout	Not Being Developed Further	Duplicate with limited additional benefit and impacts to Article 97 land.	April 2020		Feb 2021
SS-9	Utility Corridor Peanut Roundabout	Frontage road parallel to Route 6 EB. Peanut roundabout underneath new Route 6 bridge structure. All ramps except Route 6 EB off-ramp moved to utility corridor.	Active		July 2021		
SS-9.1	Utility Corridor Partial Roundabout	Similar to SS-9 except Route 6 WB On-Ramp remains in existing location at Cranberry Highway.	Active		July 2021		
SS-9.1A	Utility Corridor Flattened Route 6 WB Off Ramp	Modified SS-9.1 Route 6 WB Off Ramp to improve ramp geometry.	Active		May 2022		



Alt ID	Name	Alternative Description or Sub-Alternative Modification	Status	Reason for Discarding	Date of Initial Development	Date of Modification	Date Development Held
<b>Bourne</b>							
BP-B-1	East Bike/Ped crossing with switchbacks on the north	Crosses the canal on the east side of the bridge. Connects to the Canal Trail on the North with a series of switch backs. Connects to the canal on the south with a long trail down to grade to meet existing.	Active		April 2021		
BP-B-2	East Bike/Ped crossing with run along Scenic Highway to Tie Down	Not Being Developed Further	Active		April 2021		
BP-B-3	West Bike/Ped Crossing with local access through Nightengale Road	Crosses the canal on the west side of the bridge. Connects to the Canal Trail and Local Access on the North by following the existing on ramp around and then connects over to Nightengale Road.	Active		April 2021		
BP-B-3.1	West Bike/Ped Crossing with local access through Nightengale Road	Crosses the canal on the west side of the bridge. Connects to the Canal Trail and Local Access on the North by a path in the infield of the SB on ramp and then connects over to Nightengale Road.	Active		August 2021		
BP-B-4	East Bike/Ped Crossing with local access to canal trail	Crosses the canal on the east side of the bridge. Connects to the Canal Trail and Local Access on the North by following Scenic Highway and following the NB on ramp on the South with an at grade crossing at intersection of Trowbridge and Sandwich.	Active		August 2021		
BP-B-5	West Bike/Ped Crossing with local access via Scenic Hwy	Crosses the canal on the west side of the bridge. Connects to the Canal Trail and Local Access on the North by the extension of Scenic Hwy in the interchange alternative BN-1. The trail follows Scenic Hwy under the mainline to the intersection with Nightengale Road.	Active		Sep-21		
BP-B-6	West Bike/Ped Crossing with local access via Sandwich Road	Crosses the canal on the west side of the bridge. Connects to Sandwich Road by following the SB off ramp for interchange alternative BS-9. Connects to the Canal Trail and Local Access on the North with a looping trail west of the mainline which passes under the mainline to a local road connection.	Active		Sep-21		
BP-B-7	West Bike/Ped Crossing with local access through Nightengale Road	Crosses the canal on the west side of the bridge. Connects to the parking lot on the South via a looping trail path west of the mainline. Connects to the Canal Trail and Local Access on the North by following the existing on ramp around and then connects over to Nightengale Road.	Active		Sep-21		
BP-B-8	West Bike/Ped Crossing with local access via Scenic Hwy	Crosses the canal on the west side of the bridge. Connects to the Canal Trail and Local Access on the North by the SB on ramp from Scenic Hwy in the interchange alternative BN-13. The trail follows Scenic Hwy under the mainline to the intersection with Nightengale Road.	Active		Oct-21		

Alt ID	Name	Alternative Description or Sub-Alternative Modification	Status	Reason for Discarding	Date of Initial Development	Date of Modification	Date Development Held
<b>Sagamore</b>							
BP-S-1	East Bike/Ped Crossing Local Access	Provides priority to Local Access. Bike Ped crosses on the east side of the bridge and connects locally via Canal Street on the North and Cranberry Highway/Adams Street on the South.	Not Being Developed Further	Development held due to steep grades for long distances (over 4% with a maximum grade of 4.77%).	April 2021		May 2021
BP-S-2	West Bike/Ped Crossing with southern access via Cranberry Highway Extension	Crosses the canal on the west side of the bridge. Connects to the canal trail via a loop that runs west of Route 6 and then down to the canal. South of the canal, the bike ped trail provides local access along Cranberry Highway Extension.	Not Being Developed Further	Development held due to steep grades for long distances (over 4% with a maximum grade of 5.00%).	April 2021		May 2021
BP-S-2.1	East Bike/Ped with access to Mid Cape Connector South of Market Basket	Crosses the canal on the east side of the bridge. Connects to the canal trail via a loop that runs under Route 6 to the proposed parking lot area and then down to the canal. South of the canal, the bike ped trail goes over the NB on ramp and Cranberry Highway and then under Route 6 and the SB off Ramp. It then follows along Mid Cape Connector and over Sandwich Road.	Active		April 2021		
BP-S-2.2	West Bike/Ped Crossing	Crosses the canal on the west side of the bridge. Connects to the Canal Trail with a loop around the proposed parking area and then down to the canal. South of the canal, the bike ped trail follows the SB off ramp down along Mid Cape Connector and over Sandwich Road.	Active		April 2021		
BP-S-2.3	West Bike/Ped Crossing	Crosses the canal on the west side of the bridge. Connects to the Canal Trail with a loop around the proposed parking area and then down to the canal. The path also connects to Scenic Hwy at the signalized intersection west of the mainline. South of the canal, the bike ped trail follows the SB off ramp down along Mid Cape Connector and over Sandwich Road.	Active		Oct-21		
BP-S-3	West Bike/Ped Crossing Local Access	Provides priority to Local Access. Bike Ped crosses on the west side of the bridge and connects locally via Canal Street on the North and Cranberry Highway/Adams Street on the South. Connection on the north requires a loop west of Route 6 to get down to grade and the trail runs under Route 6 to get to the east side.	Not Being Developed Further	Development held due to steep grades with a maximum grade of 5% needed along the Cranberry Highway Extension.	April 2021		May 2021
BP-S-4	East Bike/Ped with southern access via Adams St	Crosses the canal on the east side of the bridge. Connects to the canal trail via a loop that runs under Route 6 to the proposed parking lot area and then down to the canal. South of the canal, the bike ped trail provides local access at Adams St/Cranberry Highway and will require a signal on Sandwich Road and updates to the RR Crossing for access to the Canal Trail.	Active		July 2021		

PRE-DECISIONAL AND DELIBERATIVE

Alt ID	Name	Alternative Description or Sub-Alternative Modification	Status	Reason for Discarding	Date of Initial Development	Date of Modification	Date Development Held
BP-S-5	East Bike/Ped with southern access via Cranberry Highway Extension	Crosses the canal on the east side of the bridge. Connects to the canal trail via a loop that runs under Route 6 to the proposed parking lot area and then down to the canal. South of the canal, the bike ped trail provides local access along Cranberry Highway Extension.	Active		July 2021		
BP-S-6	East Bike/Ped with access via helix ramp structure	Crosses the canal on the east side of the bridge. Connects to the canal trail via a helix ramp structure on the north side. South of the canal, the bike ped trail provides local access along Sandwich Road via a helix ramp structure.	Active		August 2021		

# Attachment 5 Traffic Documentation

5.1 Existing 2019 Conditions Traffic Analysis

5.2 Summary of Future No Build Modeling Process and Results (Draft)

## 5.1 Existing 2019 Conditions Traffic Analysis

**Date**  
August 30, 2021

**To**  
Amy Getchell, MassDOT



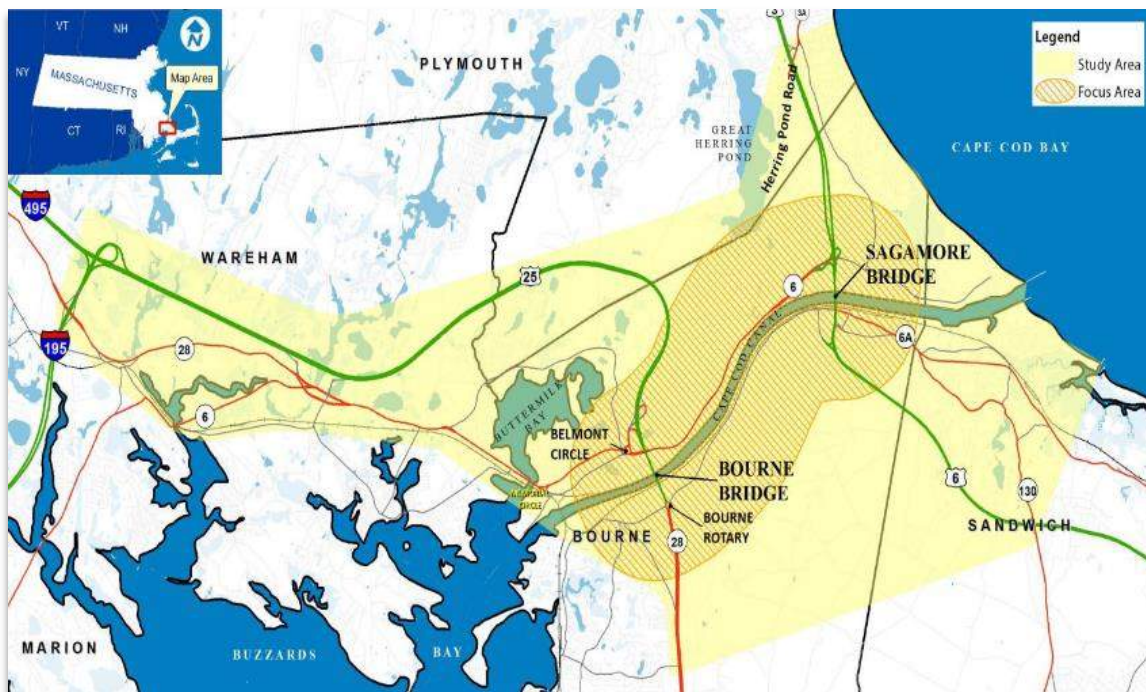
**PROJECT  
CORRESPONDENCE**

**From**  
Alexandra Siu, PE, PTOE  
Joshua Herman, PE  
Elena Aung, EIT

**Subject**  
Cape Cod Canal Area Transportation Improvement Program  
Existing 2019 Conditions Traffic Analysis

**Introduction**

HNTB developed existing conditions traffic models for the 2019 Base Year utilizing Massachusetts Department of Transportation (MassDOT) approved traffic analysis tools, including Synchro (version 10), SIDRA 7, HCS 7, and VISSIM (version 11). This memorandum describes the methodology used to calibrate the existing traffic analysis models for the 2019 Base Year for Cape Cod Canal Area Transportation Improvement Program (CCC TIP) and summarizes the results of the analysis. The general study area is shown in Figure 1, which includes major regional roadways, interchanges and intersections within Plymouth, Wareham, Bourne, and Sandwich that are impacted by traffic crossing the Cape Cod Canal. The focus area for the study consists of the 2-mile area centered around the Bourne and Sagamore Bridges.



**Figure 1: Overall Study Area Map**

## Existing Traffic Data

Base Year 2019 traffic models were developed for the following six time periods:

- Fall Weekday AM peak hour (off-peak season)
- Fall Weekday PM peak hour (off-peak season)
- Fall Saturday Midday peak hour (off-peak season)
- Summer Weekday AM peak hour (peak season)
- Summer Weekday PM peak hour (peak season)
- Summer Saturday Midday peak hour (peak season)

New traffic counts were not collected in 2020 given the non-typical traffic patterns and volumes due to the ongoing COVID-19 pandemic. Instead, an alternate methodology to adjust the 2014 count data to the 2019 Base Year was used. This methodology is detailed in the memorandum *Methodology to Estimate 2019 Base Year Volumes* dated December 18, 2020 and approved by MassDOT. The approved 2019 Base Year traffic volumes are provided in Appendix A.

Based on the 2014 count data and adjusted 2019 Base Year traffic volumes, the peak hours were identified as follows:

- Weekday AM Peak Hour (Summer and Fall): 7:00AM – 8:00AM
- Weekday PM Peak Hour (Summer and Fall): 4:00PM – 5:00PM
- Saturday Midday Peak Hour (Summer and Fall): 12:00PM – 1:00PM

In order to calibrate the 2019 Base Year traffic models, data was collected from the following sources:

- Record plans for the traffic signals within the study area were obtained by MassDOT District 5
- A site visit was performed to inspect the traffic signal controllers and download current timing information
- Field observations were conducted to observe traffic patterns and behavior
- Google Maps “Typical Traffic Conditions” feature for typical queue lengths
- INRIX typical travel times

## Traffic Analysis Methodology

Existing capacity analyses assign a qualitative level-of-service (LOS) letter grade to traffic facilities during various peak hours. The concept of LOS is defined as a qualitative measure based on quantitative model outputs that describe operational conditions within a traffic stream and their perception by the traveling public. LOS is identified based on average delay per vehicle (measured in seconds per vehicle) at local signalized and unsignalized intersections and based on densities on freeway sections and at merge-diverge points (measured in vehicles per mile per lane). LOS is represented using letter grades “A” through “F”, with LOS A representing very low delays and free flow conditions and LOS F representing unacceptable conditions for most drivers and conditions in which vehicle demand generally exceeds roadway capacity. LOS A, LOS B, and LOS C are generally considered acceptable conditions; LOS D is generally considered marginally acceptable conditions; and LOS E and LOS F are generally considered unacceptable to most drivers.

The program study area consists of freeway interchanges and intersections. The following analysis tools were used to analyze the 2019 Base Year conditions:

- Synchro 10 – local unsignalized and signalized intersections
- SIDRA 7 – roundabouts, rotaries, and traffic circles
- HCS 7 – multilane highway segments and freeway merges/diverges
- VISSIM 11 – all key highways and intersections within the focus area (2-mile radius of the bridges) to show the interaction between the above roadway facilities and their impacts on each other

The calibrated existing conditions 2019 Base Year traffic models will be used to create Future Year 2045 No Build and Build condition models to assess expected traffic operations with proposed roadway concept alternatives and future year traffic volumes.

## Existing Traffic Operations

Traffic volumes and congestion levels in the vicinity of the Cape Cod Canal are typically highest during the Summer when there are more visitor trips to Cape Cod and the islands. Vehicular access to Cape Cod is exclusively possible via the Bourne Bridge and the Sagamore Bridge. Both bridges operate with two 10-foot-wide travel lanes per direction with speed limits of 40 miles per hour. Commercial traffic is permitted across both bridges, and the narrow 10-foot-wide lanes combined with steep grades on both bridges cause traffic slowdowns on the inclines from both directions.

The Bourne Bridge is accessed from points north and west via Route 25, which carries three travel lanes per direction, but narrows to two travel lanes approaching the bridge. Heavy traffic volumes merging from the entrance ramp from Belmont Circle combined with steep inclines on the bridge itself cause congestion on the bridge approach in most peak hours. Route 25 EB terminates immediately south of the Bourne Bridge at the Bourne Rotary, which is another source of congestion during peak hours. Difficulty merging into the rotary causes queueing on Route 25 to extend for several miles during some peak hours. Limited capacity and heavy traffic volumes in the Bourne Rotary also causes queueing to extend back onto its other approaches from northbound Route 28, westbound Sandwich Road, and eastbound Trowbridge Road. Queuing on northbound Route 28 often extends approximately 1 to 2 miles during peak hours.

The Sagamore Bridge is accessed from points north via Route 3/Pilgrims Highway and from points on Cape Cod via US Route 6. In the southbound direction, Route 3 carries two travel lanes toward the Sagamore Bridge and narrows to a single lane as Route 3 approaches the bridge. The single lane from Route 3 is joined by an add lane from the entrance ramp from Scenic Highway (US Route 6), to form the two lanes that are carried over the bridge. Congestion stemming from the steep grade and the narrow lanes on the bridge and the lane reduction on Route 3 cause queues to extend back from the bridge approximately 1 to 2 miles during peak hours. In the northbound direction, US Route 6 carries two travel lanes toward the Sagamore Bridge. A heavy merge from the entrance ramp from Cranberry Highway immediately upstream of the bridge causes traffic on Route 6 to slow, creating congestion approaching the Sagamore Bridge.

Since the bridges are only approximately three and a half miles apart, drivers often use the bridges interchangeably based on congestion levels. Scenic Highway generally carries two lanes of east-west traffic per direction and connects the Bourne Bridge with the Sagamore Bridge on the north side of the canal. Sandwich Road generally carries one lane of east-west traffic per direction connecting the bridges on the south side of the canal. Drivers use Scenic Highway and Sandwich Road to reach the other bridge if



navigational apps and dynamic message signage along the highways indicate lesser congestion on one of the two bridges during peak hours. The traffic models discussed in this memo were calibrated to closely reflect these unique operating conditions.

## SYNCHRO 10 Analysis

Existing local intersection traffic models were built using Synchro 10. The following intersections were included in the models and analyzed:

### Unsignalized Intersections

- Maple Springs Rd at NB Rte. 25 on-ramp
- Maple Springs Rd at SB Rte. 25 off-ramp
- Glen Charlie Rd at NB Rte. 25 off-ramp
- Glen Charlie Rd at SB Rte. 25 on-ramp
- Sandwich Rd/County Rd at Trowbridge/Shore Rd
- Trowbridge Rd at Veterans Way
- Sandwich Rd at Bourne Rotary Connector
- Sandwich Rd at Upper Cape Cod Tech School
- Sandwich Rd at Harbor Lights Rd
- Sandwich Rd at Jefferson Rd
- Sandwich Rd at Jarvis Rd
- Herring Pond Rd at State Rd
- Herring Pond Rd at NB Rte. 3 ramps
- Herring Pond Rd at SB Rte. 3 ramps
- State Rd at NB Rte. 3 on-ramp
- Cranberry Hwy at Adams St
- Sandwich Rd at Adams St
- Cranberry Hwy at Sandwich Rd/Regency Drive
- Old King's Hwy (Rte. 6A) at Main St (Rte. 130)/Tupper Rd
- Old King's Hwy (Rte. 6A) at Tupper Rd
- Water St. (Rte. 130) at Beale Avenue
- Main St at Beale Avenue
- Old King's Hwy (Rte. 6A) at Main St/Old Main St
- Quaker Meeting House Rd at EB Rte. 6 ramps
- Quaker Meeting House Rd. at WB Rte. 6 ramps
- Rte. 130 at Cotuit Rd
- Nathan Ellis Hwy (Rte. 151) at NB Rte. 28 ramps
- Nathan Ellis Hwy (Rte. 151) at SB Rte. 28 ramps

### Signalized Intersections

- Scenic Hwy (Rte. 6) at Nightingale Rd/Andy Olivia Drive
- Sandwich Rd at Mid-Cape Connector
- Mid-Cape Connector at Factor Outlet Way
- Scenic Hwy at Church Lane
- Scenic Hwy at SB Rte. 3 off-ramp
- Meetinghouse Lane at State Rd./Canal St
- Forestdale Rd (Rte. 130) at EB Rte. 6 ramps
- Water St (Rte. 130) at WB Rte. 6 ramps

The levels of service for individual traffic movements at signalized and unsignalized intersections within the study area were determined based on criteria set forth in the Transportation Research Board's (TRB) Highway Capacity Manual (HCM) 6<sup>th</sup> Edition. Table 1 summarizes the delay criteria for each level of service letter grade at unsignalized and signalized intersections.

**Table 1:** Intersection LOS Criteria (HCM 6<sup>th</sup> Edition)

LOS	Delay (seconds per vehicle)	
	Unsignalized	Signalized
A	≤10	≤10
B	>10 and ≤15	>10 and ≤20
C	>15 and ≤25	>20 and ≤35
D	>25 and ≤35	>35 and ≤55
E	>35 and ≤50	>55 and ≤80
F	>50	>80

*Exhibits 19-8, 20-2, and 21-8, HCM 6<sup>th</sup> Edition*

The study area intersections within a 2-mile radius of the two bridges typically experience higher levels of traffic volumes and congestion than intersections further from the bridges due to the high concentration of traffic crossing the two bridges.

During the three Fall peak hours, most of the intersections analyzed operate at overall intersection LOS D or better. The following locations within the focus area operate at LOS E or F during one or more of the Fall peak hours:

- Sandwich Rd./County Rd. at Trowbridge Rd./Shore Rd. (Weekday PM – LOS F)
- Sandwich Rd. at Bourne Rotary Connector (Weekday AM/PM- LOS F; Saturday Midday- LOS E)
- Sandwich Rd. at Upper Cape Cod Technical School (Weekday PM– LOS F)
- Meetinghouse Lane at State Rd./Canal St. (Weekday PM – LOS E)
- Cranberry Hwy. at Sandwich Rd./Regency Drive (Weekday AM – LOS E; Weekday PM and Saturday Midday – LOS F)

During the three Summer peak hours, most of the intersections analyzed operate at overall intersection LOS D or better, with the following exceptions:

- Scenic Hwy. (Rte. 6) at Nightingale Rd./Andy Olivia Drive (Weekday PM– LOS F)
- Sandwich Rd./County Rd. at Trowbridge Rd./Shore Rd. (Weekday PM– LOS F)
- Sandwich Rd. at Bourne Rotary Connector (All Peak Hours– LOS F)
- Meetinghouse Lane at State Rd./Canal St. (Weekday PM – LOS E)
- Cranberry Hwy. at Sandwich Rd./Regency Drive (Weekday AM and PM – LOS F)

Level of Service tables that summarize the results of the existing capacity and queue analyses performed in Synchro for all six peak hours at all study area intersections can be found in Tables B-1 and B-2, which are provided in Appendix B. A graphical representation of the intersection levels of service are provided in Figures 2 and 3.

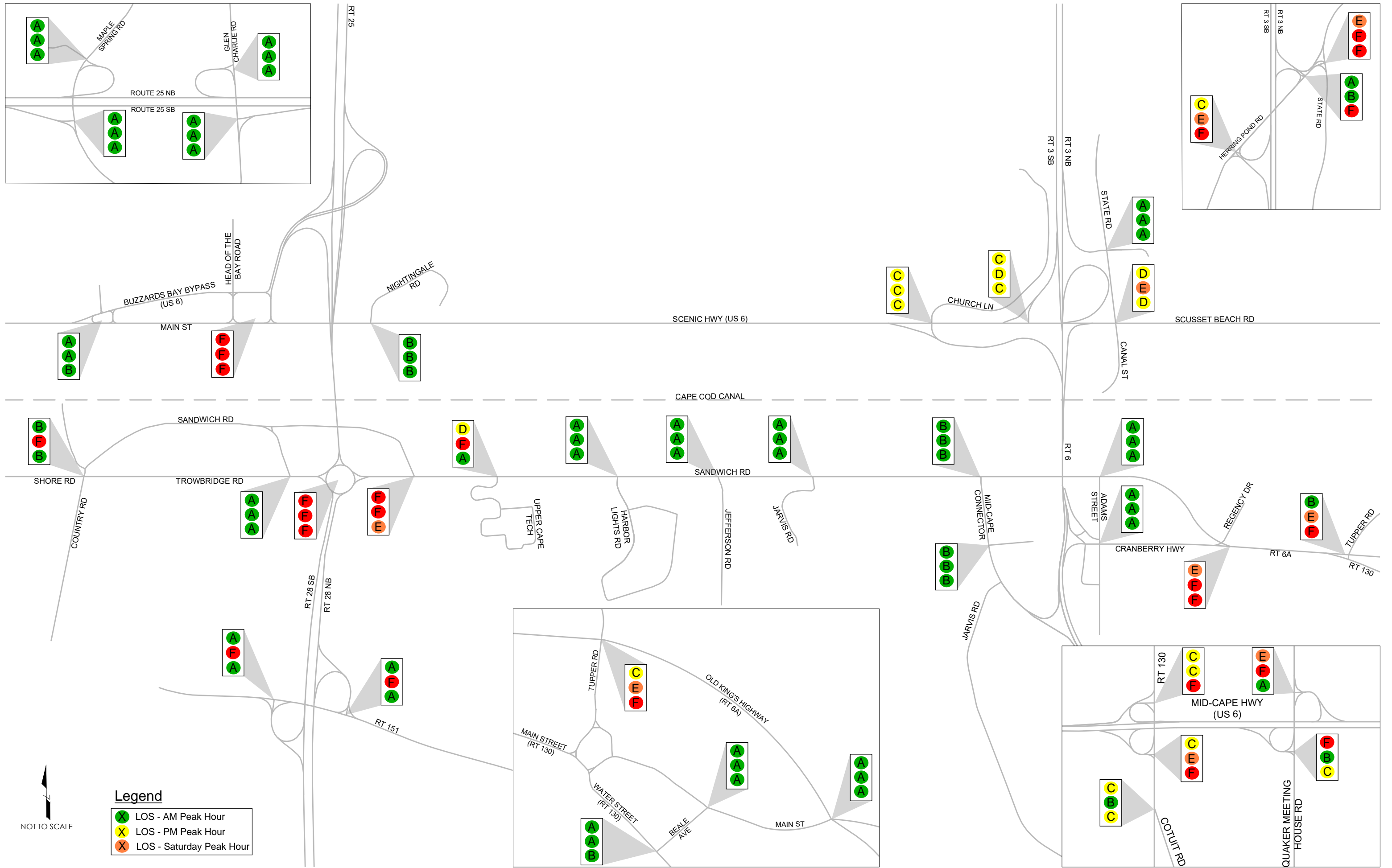


Figure 2: Existing (2019) Intersection Level of Service Summary - Fall

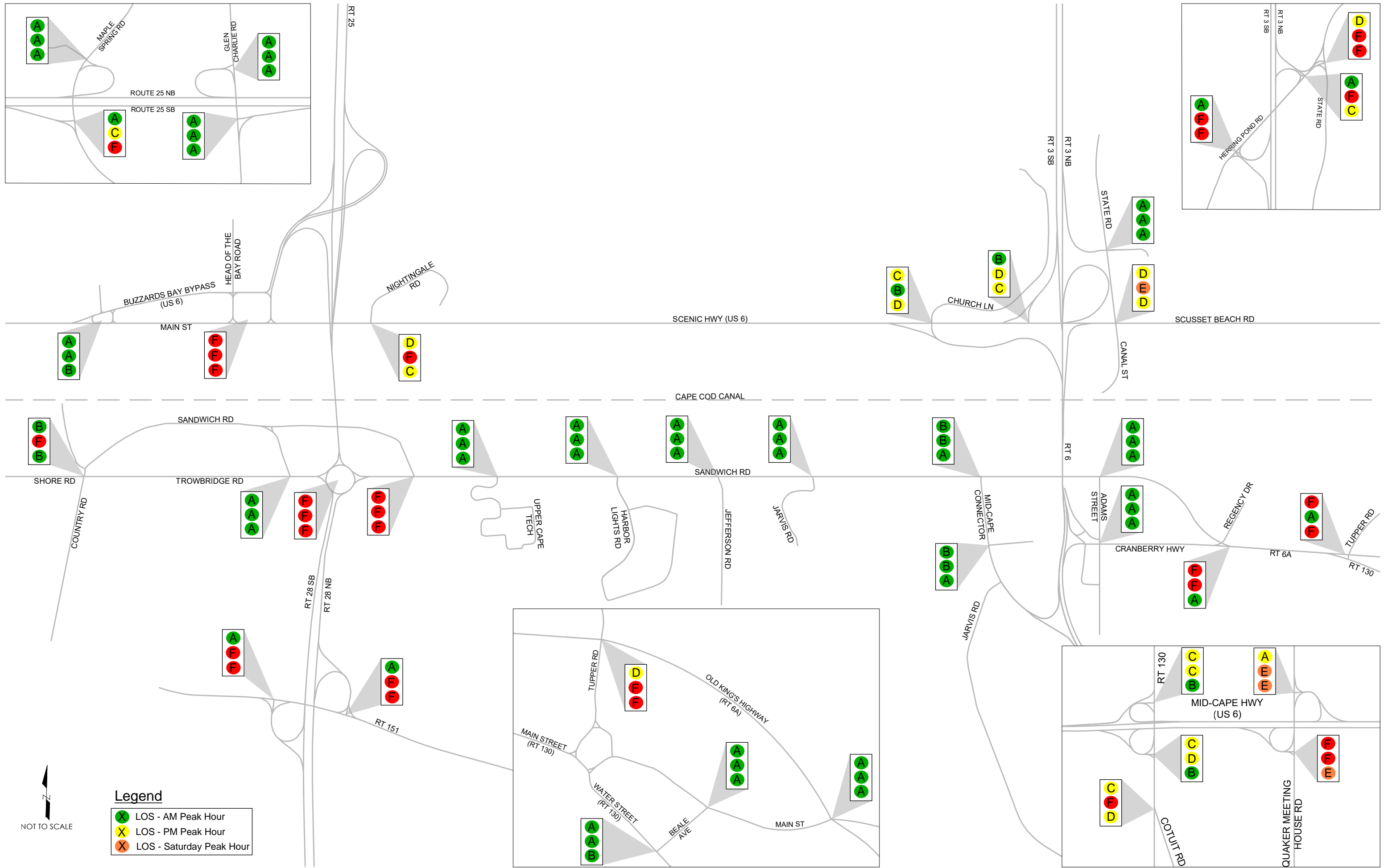


Figure 3: Existing (2019) Intersection Level of Service Summary - Summer

## SIDRA 7 Analysis

Several unsignalized traffic circles and rotaries could be found throughout the study area. The Buzzards Bay Rotary and Belmont Circle are located on the north side of the Bourne Bridge, while the Bourne Rotary is located on the south side of the Bourne Bridge. SIDRA 7, which is based on the methodology prescribed in HCM 6<sup>th</sup> Edition, was used to analyze the existing traffic conditions at each of these intersections.

Table 2 summarizes the level of service criteria for traffic movements at each of the rotaries. Level of Service tables that summarize the results of the SIDRA analysis performed for all six peak hours can be found in Tables B-1 and B-2 in Appendix B. A graphical representation of the traffic circle/rotary levels of service is provided in Figures 2 and 3.

**Table 2:** LOS Criteria for Roundabouts (HCM 6<sup>th</sup> Edition)

<b>LOS</b>	<b>Delay (seconds per vehicle)</b>
A	≤10
B	>10 and ≤15
C	>15 and ≤25
D	>25 and ≤35
E	>35 and ≤50
F	>50

*Exhibit 22-8, HCM 6<sup>th</sup> Edition*

The Bourne Rotary and Belmont Circle each operate at overall LOS F during all three peak hours analyzed for the Fall and Summer seasons. Heavy traffic volumes from all approaches combined with geometric constraints at the Bourne Rotary and Belmont Circle contribute the poor levels of service at both intersections. The Buzzards Bay Rotary carries lower volumes than the other two traffic circles and operates at overall LOS A or LOS B during all six peak hours analyzed.

## HCS 7 Analysis

The levels of service for multi-lane highways and/or freeways is based on vehicle density per mile of roadway segment and is measured in passenger cars per mile per lane (pc/mi/ln). Levels of Service for the study area freeway segments and freeway merges/diverges were calculated using HCS 7 software, which is based on the HCM, 6<sup>th</sup> Edition. Table 3 summarizes the level of service criteria for freeway segments. Table 4 summarizes the level of service criteria for freeway merging and diverging segments.

**Table 3:** LOS Criteria for Freeway Segments (HCM 6<sup>th</sup> Edition)

<b>LOS</b>	<b>Density (pc/mi/ln)</b>
A	≤11
B	>11-18
C	>18-26
D	>26-35
E	>35-45
F	Demand exceeds capacity OR density > 45

*Exhibit 12-15, HCM 6<sup>th</sup> Edition*

**Table 4:** LOS Criteria for Freeway Merges and Diverges (HCM 6<sup>th</sup> Edition)

<b>LOS</b>	<b>Density (pc/mi/ln)</b>
A	≤10
B	>10-20
C	>20-28
D	>28-35
E	>35
F	Demand exceeds capacity

*Exhibit 14-3, HCM 6<sup>th</sup> Edition*

Most freeway and merge/diverge sections throughout the study area operate at LOS C or better during all six peak hours analyzed. In general, sections closer to each of the bridges operate at unacceptable LOS D, LOS E, or LOS F during one or more peak hours. The following locations operate at LOS D, LOS E, or LOS F during one or more peak hours, consistent with field observations:

- Southbound Route 25 approaching Exit 10 (Belmont Circle) – (Fall Weekday PM – LOS D; Fall Weekday AM and Fall/Summer Saturday Midday – LOS E; Summer Weekday PM – LOS F)
- Southbound Bourne Bridge – (Summer Weekday AM, Fall Weekday PM and Fall Saturday Midday – LOS E; Fall Weekday AM, Summer Weekday PM and Summer Saturday Midday – LOS F)
- Northbound Bourne Bridge – (Fall/Summer Saturday Midday – LOS D; Fall Weekday PM – LOS E; Summer Weekday PM – LOS F)
- Southbound Route 25 Exit 10 merge – (Summer Weekday PM and Saturday Midday – LOS F)
- Southbound Route 3 approaching Exit 1A (Scenic Highway) – (Fall/Summer Weekday AM – LOS D; Fall Weekday PM and Summer Saturday Midday – LOS E; Summer Weekday PM and Fall Saturday Midday – LOS F)
- Southbound Sagamore Bridge – (Fall Weekday PM – LOS D; Fall/Summer Weekday AM and Fall Saturday Midday – LOS E; Summer Weekday PM and Summer Saturday Midday – LOS F)
- Northbound Sagamore Bridge – (Fall/Summer Weekday AM and Fall Saturday Midday – LOS E; Fall/Summer Weekday PM and Summer Saturday Midday – LOS F)
- Southbound Route 6 south of Sagamore Bridge – (Fall/Summer Weekday AM, Summer Weekday PM, and Fall Saturday Midday – LOS D; Summer Saturday Midday – LOS E)
- Northbound Route 6 south of Sagamore Bridge – (Summer Weekday AM, Fall Weekday PM, and Summer Saturday Midday – LOS D; Fall Weekday PM – LOS F)
- Southbound Route 3 Diverge to Exit 1A – (Summer Weekday PM – LOS F)
- Northbound Route 3 Diverge to Exit 1A – (Summer Saturday Midday – LOS D)
- Northbound Route 6 Diverge to Cranberry Highway – (Fall/Summer Weekday PM – LOS D)
- Northbound Route 6 Merge from Cranberry Highway – (Fall Weekday PM and Summer Saturday Midday – LOS D; Summer Weekday PM – LOS F)

HCS analysis was performed for all six analysis periods at the immediate key locations north and south of Bourne Bridge and Sagamore Bridge. The capacity adjustment factors (CAF) and safety adjustment factors (SAF) were calibrated to reflect the existing operation conditions and are tabulated in Tables C-1 and C-2 which are provided in Appendix C. A graphical representation of the LOS and density results of the freeway segments and merging-diverging segments are provided in Figures 4 and 5.



Figure 1 Existing (2014) Freebay Level of Service Summary - Fall



Figure 5: Existing (2014) Freebay Level of Service Summary - Summer



## VISSIM 11 Analysis

Existing conditions were modeled for each of the six peak hours identified above using PTV's VISSIM traffic microsimulation software for all key intersections, rotaries and traffic circles, and freeway segments within a 2-mile radius of the Bourne and Sagamore Bridges. Each of the models were run for 60 minutes to represent each peak hour, with a 30-minute seeding time. Each of the models were run 10 times, and the model results presented in Tables B-3 through B-6 in Appendix B reflect the averages of those 10 runs. Measures of Effectiveness (MOEs) that were output from each model and tabulated in Tables B-3 to B-6 include the following:

- Vehicle travel time
- Speed
- Processed volumes
- Density

Models were calibrated by comparing queueing observed in the model with both queue observations from field visits and using Google Maps "Typical Traffic Conditions" feature. In addition, volumes processing through the model were compared to the model inputs (from the 2019 Base Year traffic volumes) to confirm the appropriate number of vehicles were processing through the model. Finally, travel times for vehicles in the model were compared with typical real-world travel time information from INRIX. Factors were tweaked in the model to mimic real-world driving behavior to the extent possible and to calibrate the model such that the above data points (VISSIM travel times vs. INRIX travel times; VISSIM processed volumes vs. balanced 2019 traffic volume flow maps; and VISSIM queue lengths vs. Google Maps Typical Traffic Conditions) were comparable to each other. Comparison of model outputs to real-world data are presented in Tables B-3 through B-6 in Appendix B. Factors that were modified during the calibration process are presented in Table C-3 of Appendix C.

Processed volumes indicate the number of vehicles that were able to move through the study area in an hour, which is based on the demand and capacity. A comparison between VISSIM processed volumes and 2019 existing traffic volume flow maps is provided in Table B-5 of Appendix B. Locations in which the VISSIM model processes less than 80% of the expected volume based on 2019 traffic volume flow maps are highlighted in Table B-5. Such differences could be expected in a microsimulation model of this size and could be attributed to upward balancing of traffic volumes that are unable to process through congested intersections that cannot process that much volume.

Travel times from the VISSIM models along major travel routes in the study area (Routes 3, 6, 25, 28, Scenic Highway, and Sandwich Road) were selected to compare with typical travel times from INRIX; the comparisons are presented in Table B-3 of Appendix B. Locations in which the VISSIM model travel times are more than 4 minutes different from INRIX travel times are highlighted in Table B-3.

While the majority of VISSIM model outputs closely reflect INRIX data, qualitative queue lengths from Google Maps, and other real-world data collected, some model results vary from collected data due to traffic model limitations, different times of year in which data were collected, and wide variations in traffic operations from day-to-day and week-to-week. INRIX travel time data were an average of Fridays in August and October 2019 to represent Summer and Fall weekday travel times, respectively, and an average of Saturdays in August and October 2019 to represent Summer and Fall Saturday travel times, respectively. INRIX travel time data were somewhat inconsistent with field conditions and observed congestion levels.

For example, while traffic congestion is worse during Summer peak hours, travel times from INRIX for the Fall Weekday PM peak hour were longer than their Summer Weekday PM peak hour travel times on the same segments. However, the VISSIM models represent an average of all the datasets and represent a typical weekday and Saturday during the Fall and Summer seasons. These models and their results best represent base year conditions that could be used as a baseline to assess future conditions with various build alternatives.

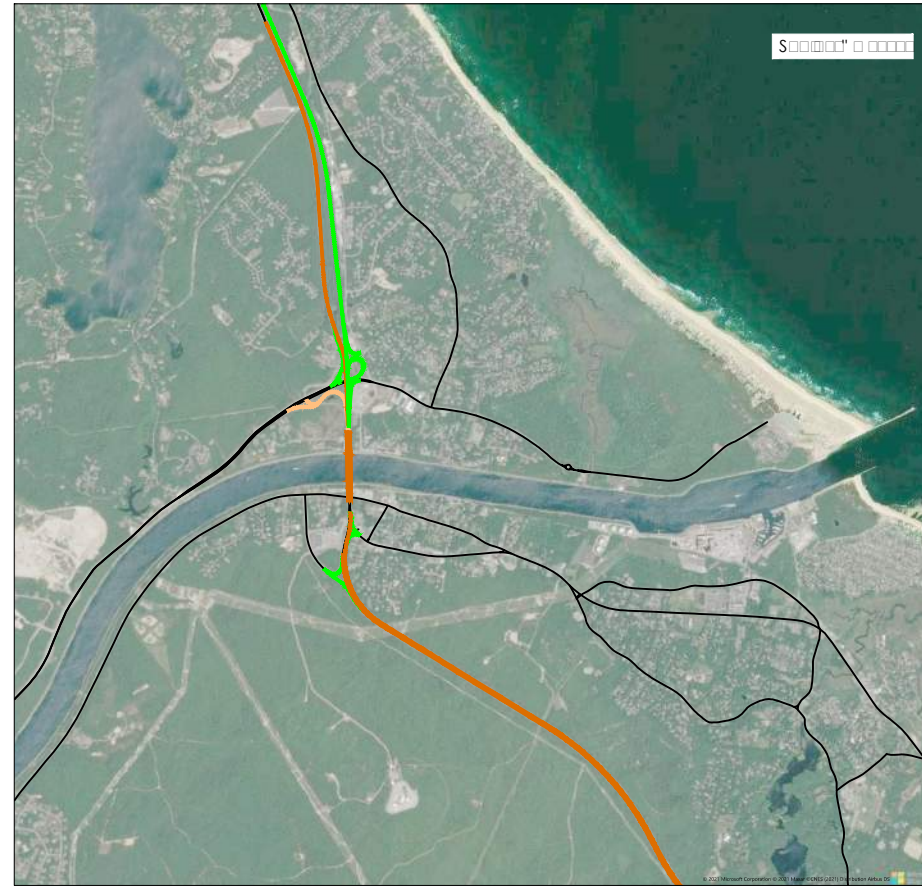
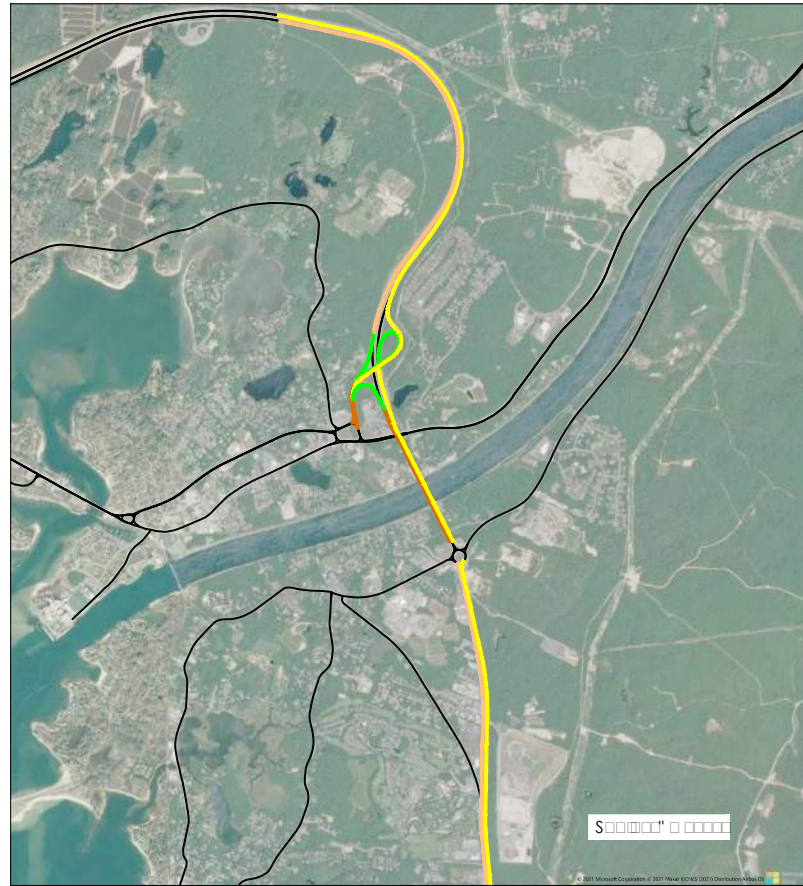
The vehicle density criteria for each level of service letter grade for freeway sections are presented in Tables 3 and 4. The densities of major freeway segments from each of the VISSIM models and their associated LOS grades are presented in Table B-6. A graphical representation of the levels of service for these major freeway sections are presented in Figures 6, 7 and 8. As expected, the approaches to both bridges from both directions operate at poor levels of service during all peak hours analyzed

During the Fall and Summer Weekday AM peak hours, the southbound side of the Bourne Bridge operates at LOS F due to congestion at the Bourne Rotary. Southbound Route 25 approaching the exit for Belmont Circle operates at LOS D during the Fall Weekday AM peak hour, and LOS E during the Summer Weekday PM peak hour. Northbound Route 28 approaching the Bourne Rotary operates at LOS D during both Fall and Summer Weekday AM peak hours. Westbound Route 6 operates at LOS F during the Fall and Summer Weekday AM peak hours approaching the northbound Sagamore Bridge; southbound Route 3 approaching the Sagamore Bridge operates at LOS F and LOS E during the Fall and Summer Weekday AM peak hours, respectively. Both directions of the Sagamore Bridge operate at LOS F during the Fall and Summer Weekday AM peak hours.

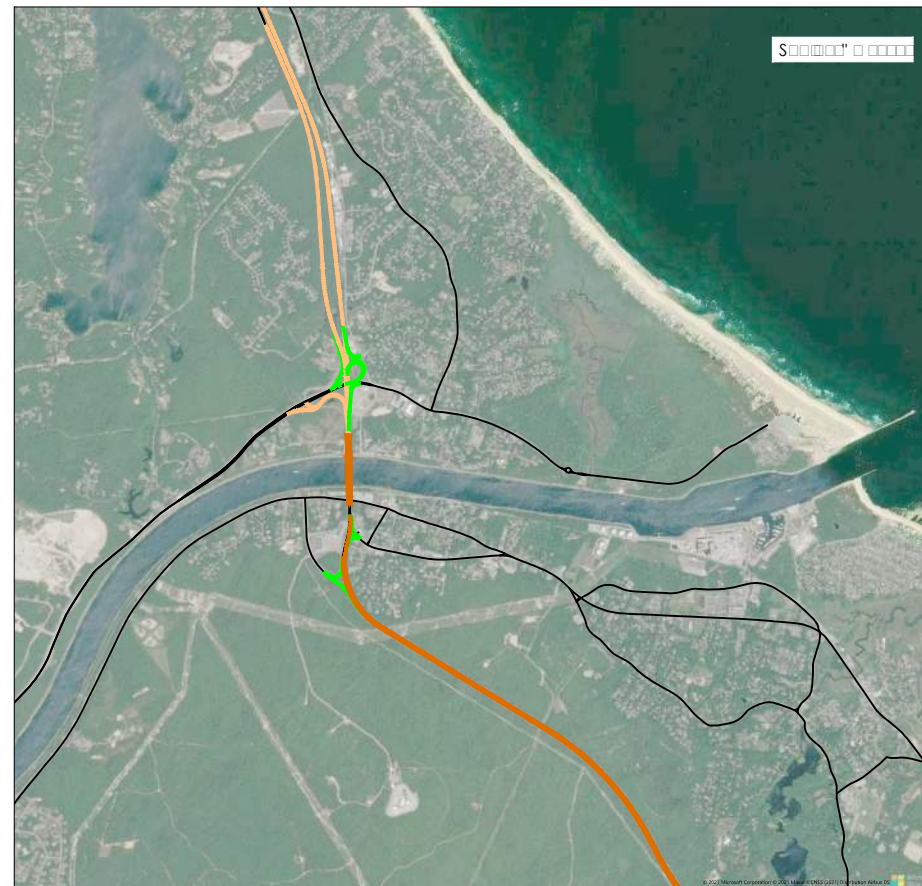
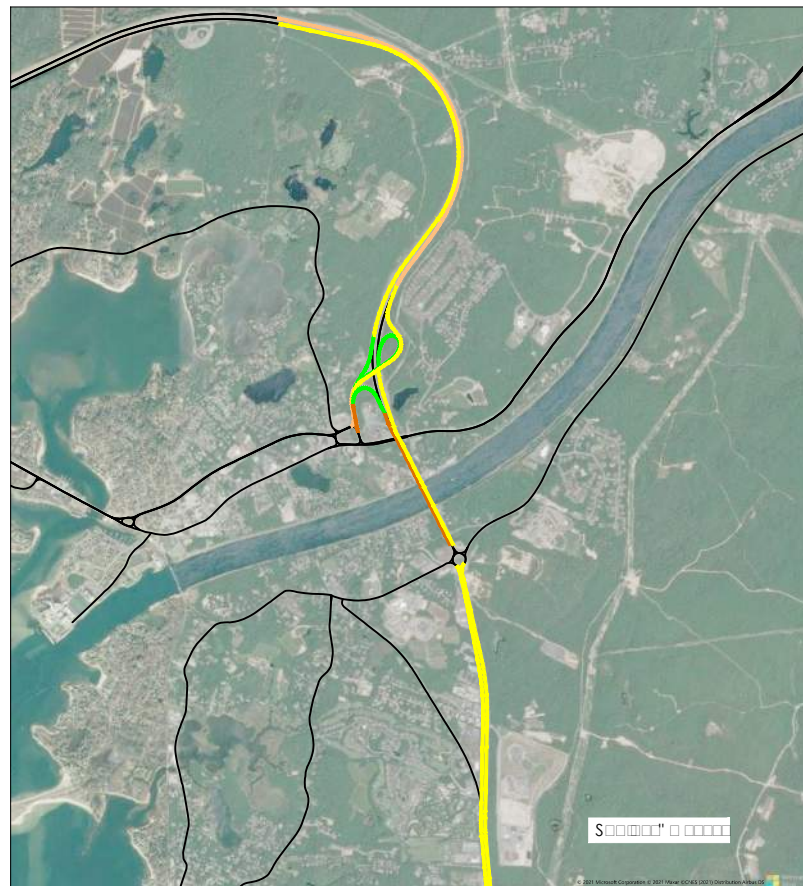
During the Fall and Summer Weekday PM peak hours, the southbound side of the Bourne Bridge and southbound Route 25 approaching the exit for Belmont Circle operate at LOS F due to congestion at the Bourne Rotary. Northbound Route 28 approaching the Bourne Rotary also operates at LOS F during both Fall and Summer Weekday PM peak hours. Westbound Route 6 operates at LOS F during the Fall and Summer Weekday PM peak hours approaching the northbound Sagamore Bridge; southbound Route 3 approaching the Sagamore Bridge operates at LOS E and LOS F during the Fall and Summer Weekday PM peak hours, respectively. Both directions of the Sagamore Bridge operate at LOS F during the Fall and Summer Weekday PM peak hours.

During the Fall and Summer Saturday Midday peak hours, the southbound side of the Bourne Bridge operates at LOS F due to congestion at the Bourne Rotary. Southbound Route 25 approaching the exit for Belmont Circle operates at LOS E during the Fall Saturday Midday peak hour and at LOS F during the Summer Saturday Midday peak hour, Northbound Route 28 approaching the Bourne Rotary operates at LOS F during both Fall and Summer Saturday Midday peak hours. Westbound Route 6 and Southbound Route 3 approaching the Sagamore Bridge operate at LOS F during the Fall and Summer Saturday Midday peak hours. Both directions of the Sagamore Bridge also operate at LOS F during the Fall and Summer Saturday Midday peak hours.

FALL WEEKDAY AM PEAK HOUR



SUMMER WEEKDAY AM PEAK HOUR



LEGEND

LOS	Density (vehicles/mile)
A-B-C	26 for Free-flow 28 for Merge-Diverge
D	26 - 35 for Free-flow 28 - 35 for Merge-Diverge
E	35-45
F	45-80
F	80-100
F	100

NOTE:

- Figures are representative of the density of vehicles per lane on each particular roadway segment identified in Table B-6 and do not represent queue lengths during periods of traffic congestion.
- Queues during peak hours may be shorter or may extend beyond the segments shown.

Figure 6

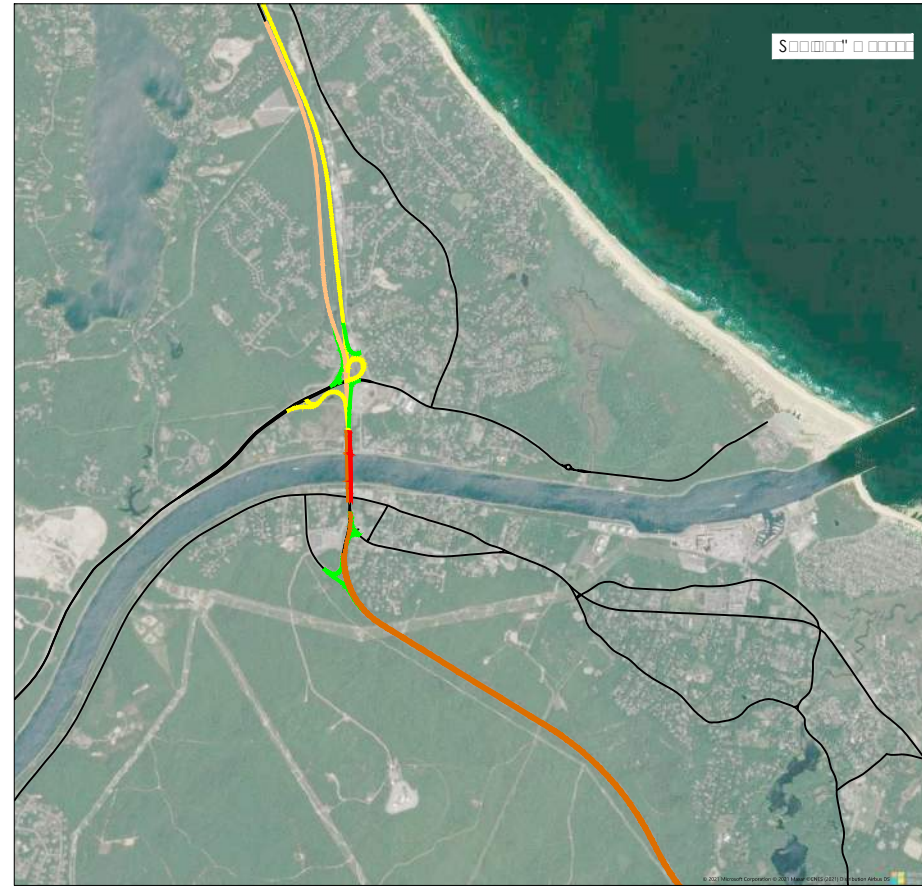
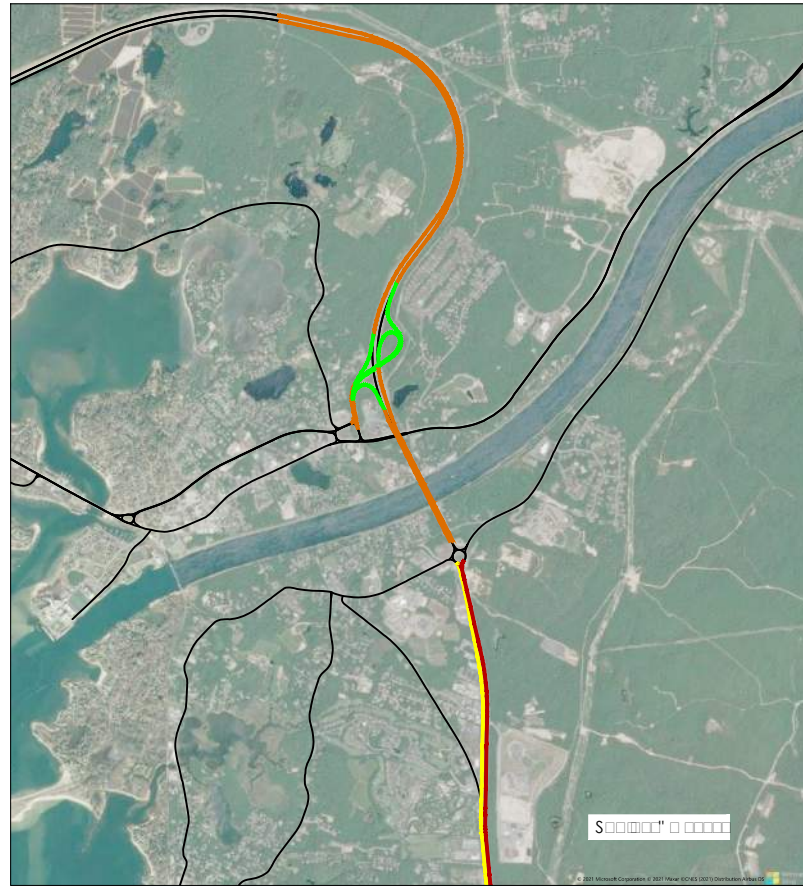
MassDOT

Cañe Cod Canal Program Management

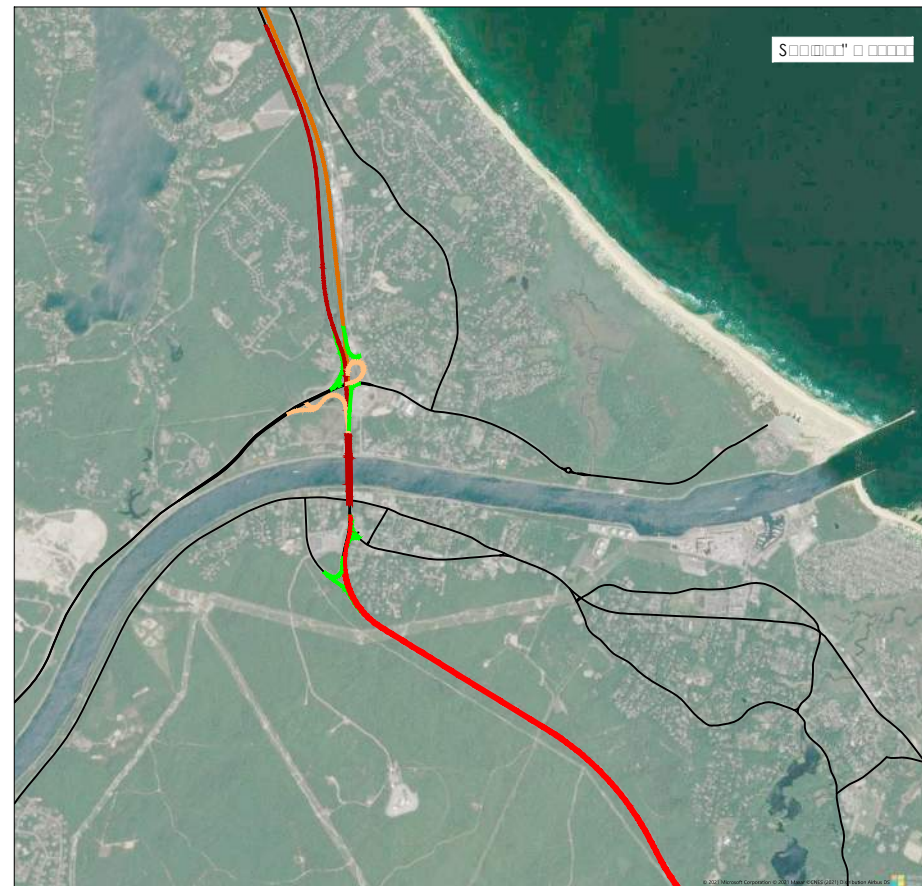
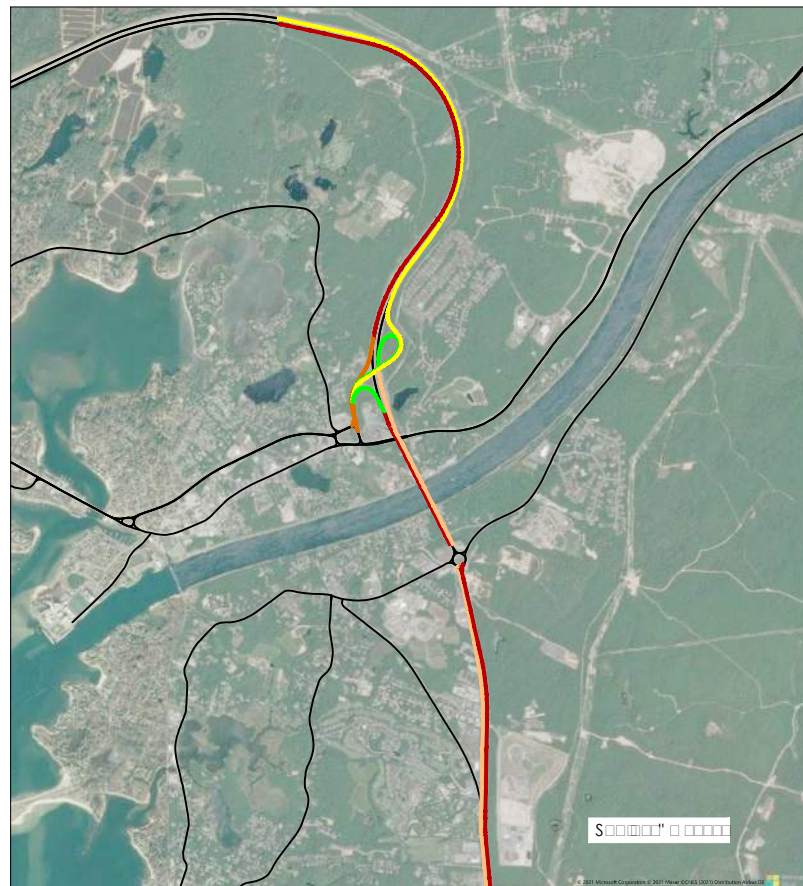
Bourne Bridge and Sagamore Bridge Density  
Fall and Summer AM  
Peak Hour

2018 Existing Conditions

FALL WEEKDAY PM PEAK HOUR



SUMMER WEEKDAY PM PEAK HOUR



LEGEND

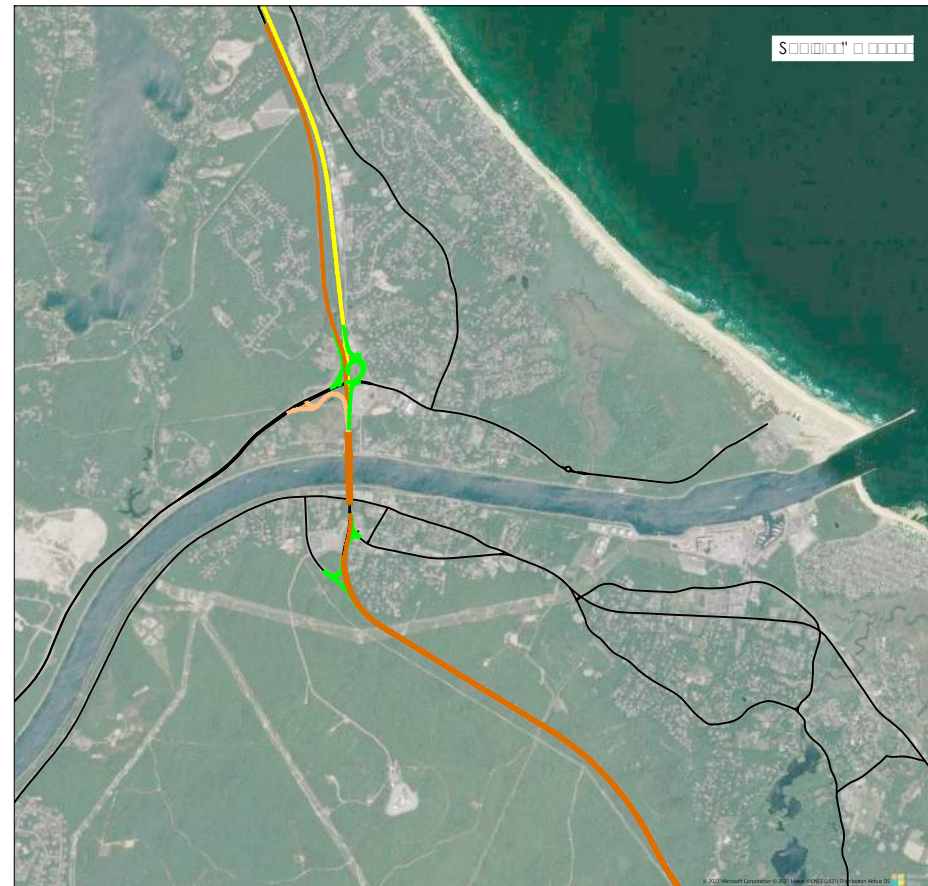
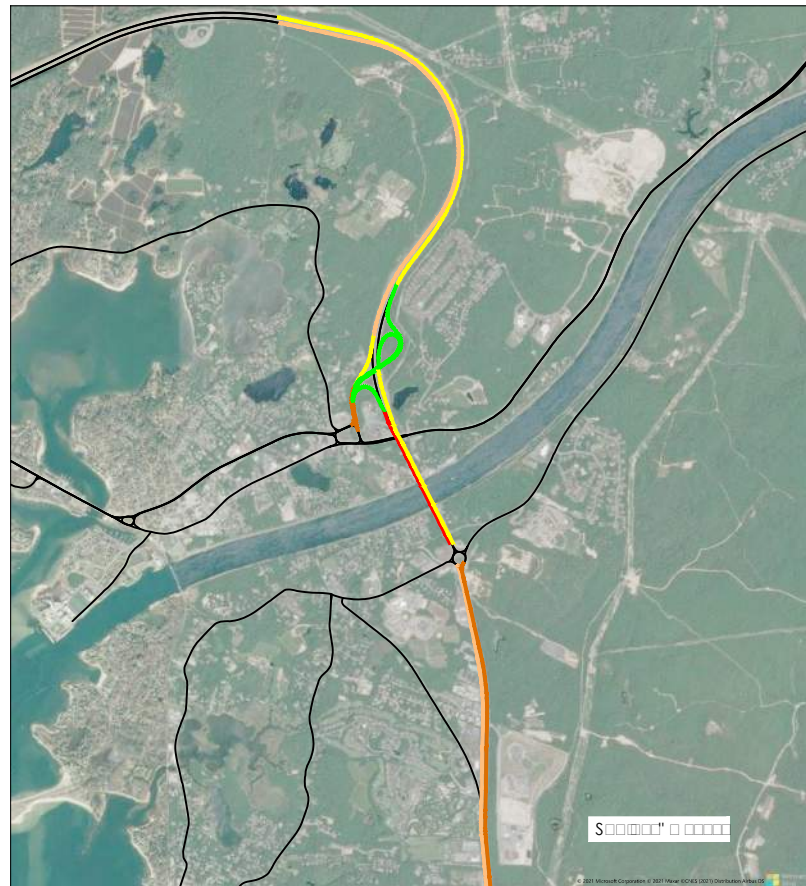
LOS	Density (vehicles/mile)
A-B-C	26 for Free-flow 28 for Merge-Diverge
D	26 - 35 for Free-flow 28 - 35 for Merge-Diverge
E	35-45
F	45-80
F	80-100
F	100

NOTE:

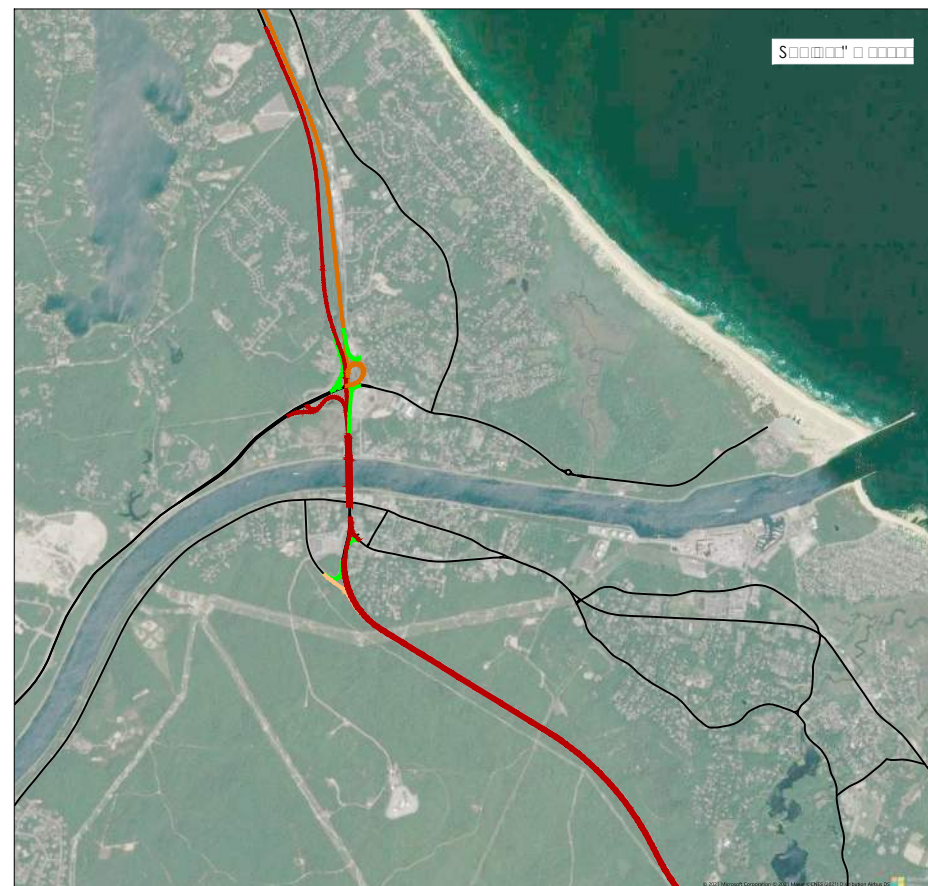
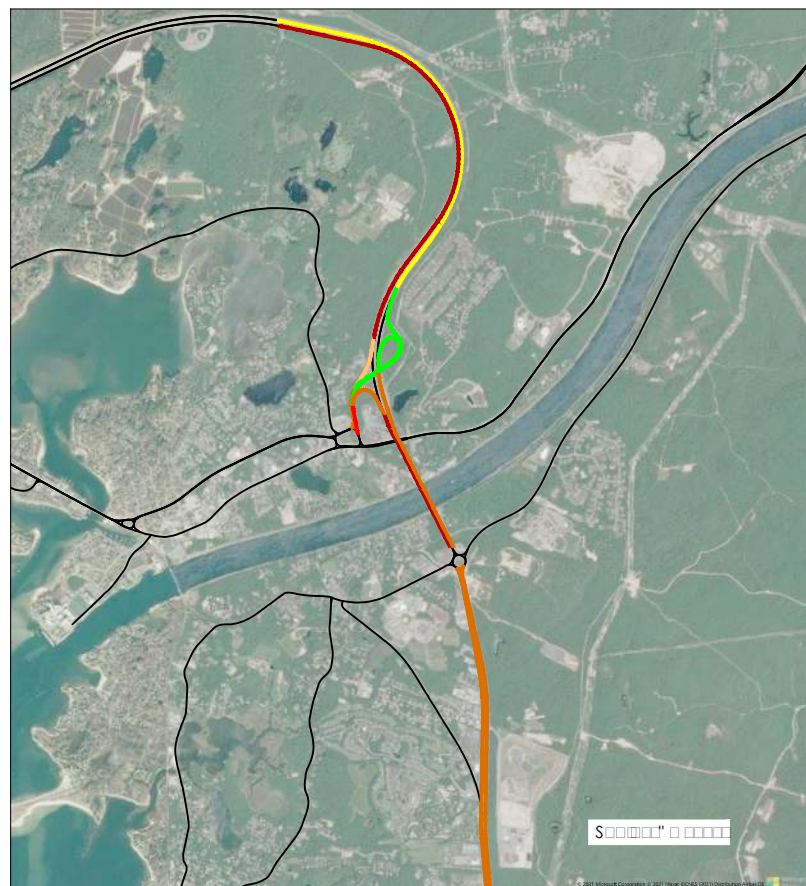
1. Figures are representative of the density of vehicles per lane on each particular roadway segment identified in Table B-6 and do not represent queue lengths during periods of traffic congestion.
2. Queues during peak hours may be shorter or may extend beyond the segments shown.

Figure 1  
 MassDOT  
 Cape Cod Canal Program Management  
 Bourne Bridge and Sagamore Bridge Density  
 Fall and Summer PM  
 Peak Hour  
 2016 Existing Conditions

FALL SAT PEAK HOUR



SUMMER SAT PEAK HOUR



LEGEND

LOS	Density (Vehicles)
A, B, C	≤ 26 for Free-flow ≤ 28 for Merge-Diverge
D	26 - 35 for Free-flow 28 - 35 for Merge-Diverge
E	35 - 50
F	50 - 80
F	80 - 100
F	≥ 100

NOTE:

- Figures are representative of the density of vehicles per lane on each particular roadway segment identified in Table B-6 and do not represent queue lengths during periods of traffic congestion.
- Queues during peak hours may be shorter or may extend beyond the segments shown.

Figure 8

MassDOT

Cañe Cod Canal Program Management

Bourne Bridge and Sagamore Bridge Density  
Fall and Summer SAT  
Peak Hour

2018 Existing Conditions

**Appendix A**  
2019 Base Year Traffic Volumes



03/15/2023 10:00 AM C:\Users\jgibson\OneDrive\Documents\Projects\Cape Cod Canal\Drawings\2019 Existing Conditions\2019 Existing Conditions.dwg



03/15/2023 10:00 AM C:\Users\jgarcia\OneDrive\Documents\Projects\Cape Cod Canal\2019 Existing Conditions\2019 Existing Conditions.dwg



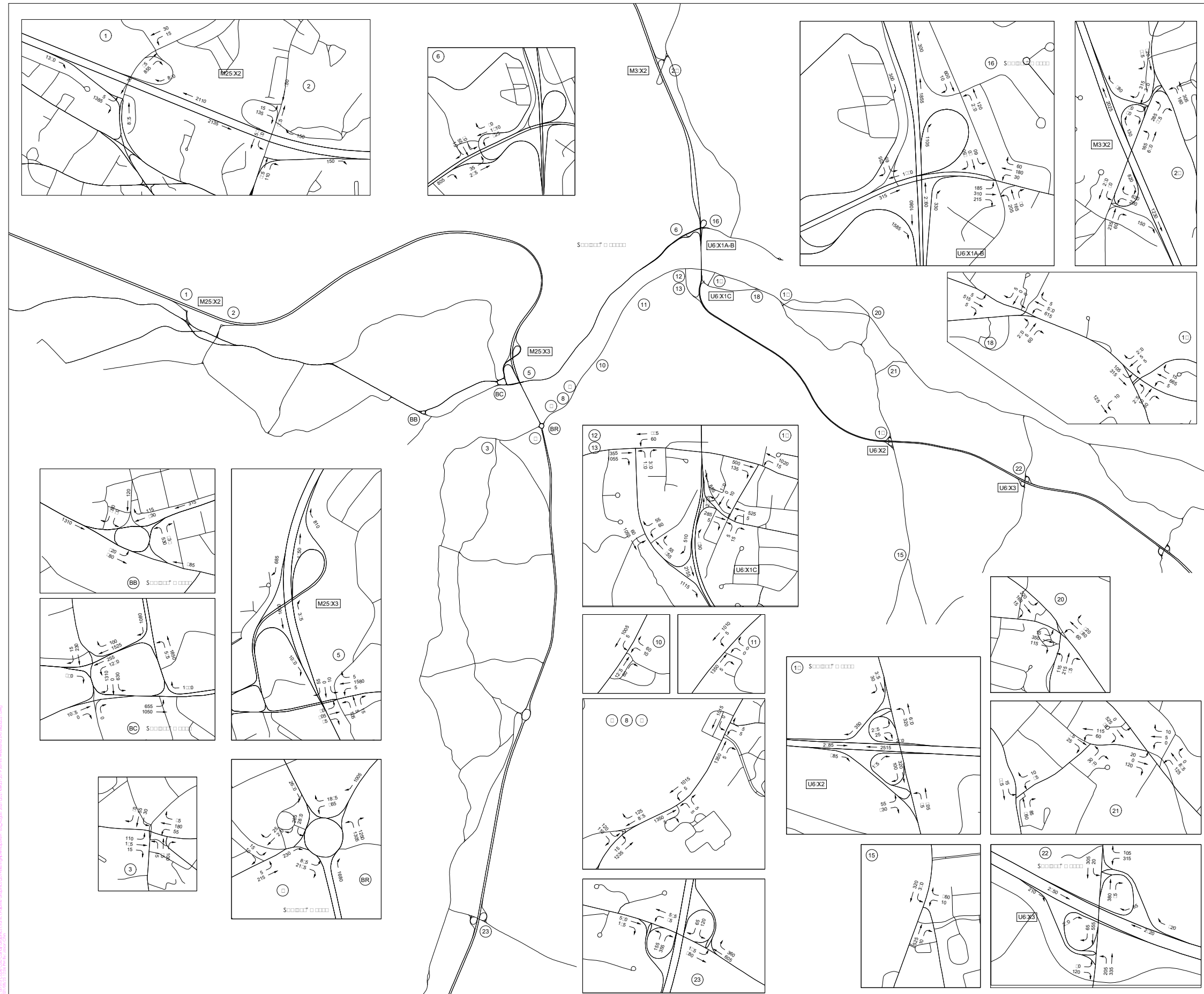


03/13/2020 10:00 AM C:\Users\jgibson\OneDrive\Documents\Projects\Cape Cod Canal\Drawings\2019 Existing Conditions\2019 Existing Conditions.dwg



03/20/2019 10:00 AM C:\Users\jgibson\OneDrive\Documents\Projects\Cape Cod Canal\2019 Existing Conditions\2019 Existing Conditions.dwg





03/15/2019 10:00 AM C:\Users\jwheeler\OneDrive\Documents\Cape Cod Canal Program Management\2019 Summer SAT Peak\2019 Existing Conditions\2019 Existing Conditions.dwg

**Appendix B**  
Results Summary Tables

SYNCHRO and SIDRA

**Table B-1: Synchro and SIDRA Results Summary - 2019 Existing Fall**

Intersection	2019 Existing Fall AM					2019 Existing Fall PM					2019 Existing Fall MID				
	LOS	Delay (sec)	v/c Ratio	50% Queue (feet)	95% Queue (feet)	LOS	Delay (sec)	v/c Ratio	50% Queue (feet)	95% Queue (feet)	LOS	Delay (sec)	v/c Ratio	50% Queue (feet)	95% Queue (feet)
<b>1:: Maple Springs Rd / Route 25 NB On-Ramp</b>															
Maple Springs Rd NB (thru)	A	0.3				A	0.2				A	0.1			
Maple Springs Rd NB (thru)	A	0.0	0.01	-	0	A	0.0	0.03	-	0	A	0.0	0.02	-	0
Maple Springs Rd NB (thru/right)	A	0.0	0.42	-	0	A	0.0	0.35	-	0	A	0.0	0.52	-	0
Maple Springs Rd SB (left/thru)	A	2.5	0.02	-	1	A	1.9	0.01	-	1	A	1.4	0.01	-	1
<b>2:: Maple Springs Rd / Route 25 SB Off-Ramp</b>															
Route 25 SB Off-Ramp EB (left)	B	11.7	0.04	-	87	B	10.7	0.03	-	131	B	12.5	0.05	-	148
Route 25 SB Off-Ramp EB (right)	B	13.0	0.54	-	87	B	14.8	0.66	-	131	C	16.1	0.68	-	148
Maple Springs Rd NB (thru)	A	0.0	0.00	-	0	A	0.0	0.00	-	0	A	0.0	0.00	-	0
Maple Springs Rd NB (thru)	A	0.0	0.00	-	0	A	0.0	0.00	-	0	A	0.0	0.00	-	0
Maple Springs Rd SB (thru)	A	0.0	0.00	-	0	A	0.0	0.00	-	0	A	0.0	0.00	-	0
<b>3:: Glen Charlie Road / Route 25 NB Off-Ramp</b>															
Route 25 NB Off-Ramp EB (left)	B	14.1	0.02	-	97	C	16.2	0.20	-	27	C	17.3	0.05	-	21
Route 25 NB Off-Ramp EB (right)	C	20.1	0.60	-	97	B	11.6	0.27	-	27	B	12.9	0.22	-	21
Glen Charlie Rd NB (thru)	A	0.0	0.00	-	0	A	0.0	0.00	-	0	A	0.0	0.00	-	0
Glen Charlie Rd SB (thru)	A	0.0	0.00	-	0	A	0.0	0.00	-	0	A	0.0	0.00	-	0
<b>4:: Glen Charlie Road / Route 25 SB On-Ramp</b>															
Glen Charlie Rd NB (thru)	A	1.4				A	0.4				A	0.5			
Glen Charlie Rd NB (thru)	A	0.0	0.12	-	0	A	0.0	0.26	-	0	A	0.0	0.24	-	0
Glen Charlie Rd NB (right)	A	0.0	0.17	-	0	A	0.0	0.06	-	0	A	0.0	0.06	-	0
Glen Charlie Rd SB (left/thru)	A	2.3	0.09	-	8	A	0.9	0.03	-	2	A	0.9	0.03	-	3
<b>5:: Buzzards Bay Rotary</b>															
Main Street (Route 6) EB (left)	A	7.3				A	8.2				B	12.6			
Main Street (Route 6) EB (left/thru)	A	8.1	0.42	-	42	A	7.0	0.33	-	30	A	9.1	0.48	-	55
Main Street (Route 6) EB (left/thru)	A	8.1	0.42	-	42	A	7.0	0.33	-	30	A	9.1	0.48	-	52
Main Street WB (thru/right)	A	6.9	0.26	-	20	A	9.0	0.45	-	43	C	20.3	0.77	-	158
Lincoln Avenue SB (left/thru/right)	A	6.1	0.12	-	7	A	8.5	0.18	-	12	A	9.7	0.23	-	16
Buzzards Bay Bypass (Route 6) SWB (left)	A	6.0	0.18	-	14	A	9.1	0.38	-	33	A	9.3	0.3	-	24
Buzzards Bay Bypass (Route 6) SWB (left/right)	A	5.9	0.18	-	13	A	9.0	0.38	-	31	A	9.0	0.3	-	23
<b>6:: Scenic Highway (Route 6) / Main Street (Route 6) / Nightingale Road / Andy Olivia Drive</b>															
Main Street (Route 6) EB (left/thru)	B	14.7				B	17.9				B	16.7			
Main Street (Route 6) EB (left/thru)	A	6.2	0.70	162	207	A	7.1	0.74	132	157	A	6.7	0.69	139	226
Main Street (Route 6) EB (thru/right)	A	6.2	0.70	162	207	A	7.1	0.74	132	157	A	6.7	0.69	139	226
Scenic Hwy (Route 6) WB (left/thru)	B	19.9	0.84	420	535	C	24.6	0.91	495	#677	C	21.6	0.85	394	#626
Scenic Hwy (Route 6) WB (thru/right)	B	19.9	0.84	420	535	C	24.6	0.91	495	#677	C	21.6	0.85	394	#626
Andy Olivia Dr NB (left/thru/right)	D	39.5	0.02	0	0	D	39.5	0.03	0	0	D	48.6	0.65	50	67
Nightingale Pond Rd SB (left/thru)	D	40.8	0.28	18	46	D	40.1	0.15	10	28	D	38.5	0.18	14	33
Nightingale Pond Rd SB (right)	D	39.5	0.05	0	14	D	39.5	0.03	0	0	D	37.8	0.06	0	13
<b>7:: Sandwich Road / Trowbridge Road / County Road / Shore Road</b>															
Shore Rd EB (left/thru/right)	B	12.0				F	254.9				B	10.7			
Shore Rd EB (left/thru/right)	A	7.8	0.07	-	6	A	8.3	0.05	-	4	A	7.9	0.07	-	6
Trowbridge Rd WB (left/thru/right)	A	7.8	0.04	-	3	A	8.0	0.09	-	7	A	7.7	0.03	-	2
County Rd NB (left/thru/right)	C	18.1	0.46	-	60	F	142.9	1.16	-	345	C	18.1	0.45	-	56
Sandwich Rd SB (left/thru/right)	D	31.0	0.57	-	91	F	1122.2	3.26	-	645	D	28.2	0.57	-	89
<b>8:: Trowbridge Rd./Veterans Way</b>															
Trowbridge Rd EB (left/thru/right)	A	0.7				A	2.9				A	0.7			
Trowbridge Rd EB (left/thru/right)	A	8.0	0.01	-	0	A	7.9	0.02	-	1	A	8.6	0.01	-	1
Trowbridge Rd WB (left/thru/right)	A	0.0	0.00	-	0	A	0.0	0.00	-	0	A	0.0	0.00	-	0
Veterans Way NB (left/thru/right)	A	0.0	0.00	-	0	A	0.0	0.00	-	0	A	0.0	0.00	-	0
Driveway SB (left/thru/right)	B	13.4	0.09	-	7	C	18.4	0.32	-	34	C	17.1	0.12	-	10
<b>9:: Bourne Rotary</b>															
General MacArthur Boulevard NB (left/thru)	F	521.0				F	419.8				F	762.5			
General MacArthur Boulevard NB (left/thru)	F	360.4	1.75	-	4706	F	597.7	2.28	-	6836	F	489.6	2.04	-	5755
General MacArthur Boulevard NB (right)	C	16.3	0.62	-	101	C	22.9	0.72	-	132	B	13.1	0.48	-	61
Sandwich Road WB (left/thru)	F	236.0	1.44	-	1849	C	23.0	0.66	-	98	F	117.7	1.16	-	904
Sandwich Road WB (right)	B	10.0	0.13	-	10	F	311.9	1.63	-	2831	B	14.2	0.41	-	43
Route 28 (Bourne Bridge) SB (left/thru)	F	941.9	3.05	-	11668	F	594.7	2.28	-	8618	F	1407.9	4.09	-	16858
Route 28 (Bourne Bridge) SB (right)	A	6.5	0.09	-	8	A	6.1	0.15	-	14	C	21.3	0.72	-	139
Trowbridge Road EB (left/thru/right)	F	136.4	1.18	-	810	F	206.2	1.36	-	1371	F	80.2	1	-	325

**Table B-1: Synchro and SIDRA Results Summary - 2019 Existing Fall**

Intersection	2019 Existing Fall AM					2019 Existing Fall PM					2019 Existing Fall MID				
	LOS	Delay (sec)	v/c Ratio	50% Queue (feet)	95% Queue (feet)	LOS	Delay (sec)	v/c Ratio	50% Queue (feet)	95% Queue (feet)	LOS	Delay (sec)	v/c Ratio	50% Queue (feet)	95% Queue (feet)
<b>10:: Sandwich Road / Bourne Rotary Connector</b>															
Sandwich Rd EB (left/right)	F	103.7				F	352.0				E	79.6			
Bourne Rotary Connector NB (left/thru)	F	648.6	2.29	-	717	F	1996.4	5.25	-	Err	F	712.8	2.38	-	565
Sandwich Rd SB (thru/right)	A	9.4	0.01	-	0	A	0.0	0.00	-	0	A	9.1	0.01	-	1
Sandwich Rd SB (thru/right)	A	0.0	0.00	-	0	A	0.0	0.00	-	0	A	0.0	0.00	-	0
<b>11:: Sandwich Road / Upper Cape Cod Technical School Driveway</b>															
Cape Cod Technical School Driveway WB (left/right)	D	42.5				F	181.3				A	0.4			
Sandwich Rd NB (thru/right)	F	630.1	2.08	-	335	F	2709.6	6.44	-	Err	F	59.0	0.16	-	13
Sandwich Rd SB (left)	A	0.0	0.00	-	0	A	0.0	0.00	-	0	A	0.0	0.00	-	0
Sandwich Rd SB (thru)	B	12.3	0.22	-	21	B	13.5	0.13	-	11	B	12.3	0.01	-	1
Sandwich Rd SB (thru)	A	0.0	0.00	-	0	A	0.0	0.00	-	0	A	0.0	0.00	-	0
<b>12:: Sandwich Road / Harbor Lights Road</b>															
Harbor Lights Rd WB (left/right)	A	0.3				A	1.1				A	1.5			
Sandwich Rd NB (thru/right)	E	40.4	0.12	-	10	F	175.6	0.48	-	41	F	95.7	0.48	-	49
Sandwich Rd SB (left/thru)	A	0.0	0.00	-	0	A	0.0	0.00	-	0	A	0.0	0.00	-	0
Sandwich Rd SB (left/thru)	B	10.3	0.01	-	1	B	12.4	0.01	-	1	B	12.1	0.00	-	1
<b>13:: Sandwich Road / Jefferson Road (Tech Drive)</b>															
Jefferson Rd (Tech Dr) WB (left/right)	A	0.0				A	0.0				A	0.1			
Sandwich Rd NB (thru/right)	A	0.0	0.00	-	0	A	0.0	0.00	-	0	D	26.9	0.05	-	4
Sandwich Rd SB (left/thru)	A	0.0	0.00	-	0	A	0.0	0.00	-	0	A	0.0	0.00	-	0
Sandwich Rd SB (left/thru)	A	0.0	0.00	-	0	A	0.0	0.00	-	0	A	0.0	0.00	-	0
<b>14:: Sandwich Road / Jarvis Road</b>															
Jarvis Rd WB (left/right)	A	0.5				A	0.5				A	0.3			
Sandwich Rd NB (thru/right)	F	70.7	0.19	-	15	F	99.5	0.25	-	20	D	28.1	0.11	-	9
Sandwich Rd SB (left/thru)	A	0.0	0.00	-	0	A	0.0	0.00	-	0	A	0.0	0.00	-	0
Sandwich Rd SB (left/thru)	B	10.5	0.01	-	1	B	12.4	0.01	-	1	B	12.3	0.01	-	1
<b>15:: Sandwich Road (Route 6 Bypass) / Mid-Cape Connector</b>															
Sandwich Rd EB (thru)	B	11.4				B	12.4				B	10.1			
Sandwich Rd EB (right)	C	21.3	0.69	133	234	C	21.0	0.71	159	266	C	20.2	0.74	156	309
Sandwich Rd WB (left)	A	0.9	0.44	0	0	A	1.7	0.60	0	0	A	1.6	0.58	0	0
Sandwich Rd WB (thru)	A	8.6	0.29	22	46	A	8.8	0.40	30	56	A	8.0	0.36	22	54
Mid-Cape Connector NB (left)	A	9.0	0.48	106	180	B	14.0	0.78	234	360	A	6.9	0.45	87	186
Mid-Cape Connector NB (right)	C	24.2	0.72	118	#241	C	26.6	0.71	115	#265	C	23.1	0.59	78	169
Mid-Cape Connector SB (thru)	B	10.9	0.16	0	29	B	14.4	0.41	33	118	B	14.2	0.32	22	77
<b>16:: Mid-Cape Connector / Factory Outlet Way</b>															
Factory Outlet Way (Market Basket Driveway) WB (left)	B	11.1				B	15.2				B	14.5			
Factory Outlet Way (Market Basket Driveway) WB (left)	C	26.9	0.10	5	17	C	30.0	0.25	30	52	C	30.8	0.24	26	51
Factory Outlet Way (Market Basket Driveway) WB (right)	C	26.9	0.10	5	17	C	30.0	0.25	30	52	C	30.8	0.24	26	51
Mid-Cape Connector NB (thru)	B	14.0	0.15	20	46	B	16.8	0.37	79	111	B	14.5	0.30	63	96
Mid-Cape Connector NB (right)	B	17.1	0.68	170	303	C	21.8	0.65	207	#381	B	19.2	0.43	115	205
Mid-Cape Connector SB (left)	A	7.1	0.05	0	12	A	7.1	0.07	0	18	A	8.7	0.06	0	19
Mid-Cape Connector SB (right)	C	25.7	0.46	47	111	C	35.0	0.64	93	149	D	35.1	0.72	129	180
Mid-Cape Connector SB (thru)	A	3.4	0.31	47	79	A	5.4	0.36	84	113	A	5.0	0.36	82	95
Mid-Cape Connector SB (thru)	A	3.4	0.31	47	79	A	5.4	0.36	84	113	A	5.0	0.36	82	95
<b>17:: Herring Pond Road / State Road</b>															
Herring Pond Rd EB (left/right)	E	42.9				F	178.9				F	358.3			
State Rd NB (left/thru)	F	92.4	1.06	-	758	F	362.2	1.73	-	1316	F	625.0	2.33	-	Err
State Rd SB (thru/right)	A	7.9	0.12	-	10	A	7.8	0.08	-	7	A	8.0	0.10	-	8
State Rd SB (thru/right)	A	0.0	0.00	-	0	A	0.0	0.00	-	0	A	0.0	0.00	-	0
<b>18:: Herring Pond Road / Route 3 NB Ramps</b>															
Route 3 NB Ramps EB (left/right)	A	7.4				B	12.0				F	56.8			
Herring Pond Rd NB (left/thru)	E	45.3	0.75	-	175	F	53.8	0.87	-	257	F	455.1	1.82	-	426
Herring Pond Rd SB (thru)	A	9.0	0.18	-	16	A	8.3	0.05	-	4	A	8.7	0.14	-	12
Herring Pond Rd SB (right)	A	0.0	0.00	-	0	A	0.0	0.00	-	0	A	0.0	0.00	-	0
Herring Pond Rd SB (right)	A	0.0	0.00	-	0	A	0.0	0.00	-	0	A	0.0	0.00	-	0
<b>19:: Herring Pond Road / Route 3 SB Ramps</b>															
Route 3 SB Ramps WB (left/right)	C	35.0				E	38.5				F	374.7			
Herring Pond Rd NB (thru/right)	F	89.3	1.06	-	528	F	99.0	1.10	-	579	F	718.7	2.53	-	1945
Herring Pond Rd SB (left/thru)	A	0.0	0.00	-	0	A	0.0	0.00	-	0	A	0.0	0.00	-	0
Herring Pond Rd SB (left/thru)	A	8.2	0.18	-	17	A	8.1	0.15	-	13	A	8.5	0.17	-	15



Table B-1: Synchro and SIDRA Results Summary - 2019 Existing Fall

Intersection	2019 Existing Fall AM					2019 Existing Fall PM					2019 Existing Fall MID				
	LOS	Delay (sec)	v/c Ratio	50% Queue (feet)	95% Queue (feet)	LOS	Delay (sec)	v/c Ratio	50% Queue (feet)	95% Queue (feet)	LOS	Delay (sec)	v/c Ratio	50% Queue (feet)	95% Queue (feet)
<b>20:: Scenic Highway (Route 6) / Church Lane / Route 6 SB On-Ramp</b>	C	22.1				C	20.7				C	23.3			
Scenic Hwy (Route 6) EB (left)	D	54.9	0.44	10	36	D	45.0	0.53	39	80	D	44.1	0.44	29	80
Scenic Hwy (Route 6) EB (thru)	C	26.6	0.97dr	304	#591	C	24.0	0.87dr	320	437	C	29.1	0.98dr	228	413
Scenic Hwy (Route 6) EB (thru/right)	C	26.6	0.97dr	304	#591	C	24.0	0.87dr	320	437	C	29.1	0.98dr	228	413
Scenic Hwy (Route 6) WB (left)	E	56.2	0.85	195	316	D	46.5	0.77	149	247	D	39.0	0.78	209	381
Scenic Hwy (Route 6) WB (thru)	A	8.9	0.85	126	305	B	11.3	0.55	209	313	B	11.9	0.50	189	285
Scenic Hwy (Route 6) WB (thru)	A	8.9	0.85	126	305	B	11.3	0.55	209	313	B	11.9	0.50	189	285
Scenic Hwy (Route 6) WB (thru/right)	A	8.9	0.51	126	305	B	11.3	0.55	209	313	B	11.9	0.50	189	285
Church Lane SB (left/thru/right)	D	52.4	0.66	76	151	D	43.7	0.56	56	99	D	42.4	0.61	80	126
<b>21:: Scenic Highway (Route 6) &amp; Route 3 SB Off-Ramp</b>	C	29.5				D	38.6				C	26.2			
Scenic Hwy (Route 6) EB (thru)	B	10.7	0.44	176	247	B	13.6	0.57	236	319	B	12.5	0.39	129	183
Scenic Hwy (Route 6) WB (thru)	C	23.2	0.90	606	555	B	19.1	0.81	428	515	B	18.8	0.78	345	387
Scenic Hwy (Route 6) WB (thru)	C	23.2	0.90	606	555	B	19.1	0.81	428	515	B	18.8	0.78	345	387
Route 3 Off-Ramp SB (left/right)	F	82.3	0.98	~315	#529	F	124.2	1.14	~433	#693	E	56.9	0.95	285	#640
<b>22:: Meetinghouse Lane / State Road / Canal Street</b>	D	51.1				E	63.9				E	73.2			
Meetinghouse Ln EB (left)	C	27.5	0.69	199	#624	C	34.1	0.88	265	#807	D	54.0	0.90	180	#472
Meetinghouse Ln EB (thru)	B	19.2	0.23	74	202	C	21.7	0.50	121	#479	D	38.9	0.52	164	304
Meetinghouse Ln EB (right)	B	19.1	0.21	0	75	B	16.8	0.17	0	63	C	32.2	0.36	0	65
Meetinghouse Ln WB (left)	D	37.8	0.11	8	34	D	37.5	0.11	5	22	D	41.3	0.17	16	40
Meetinghouse Ln WB (thru/right)	F	141.0	1.13	249	#435	F	261.8	1.43	~222	#328	F	258.7	1.41	~337	#423
Canal St NB (left)	D	40.7	0.72	147	167	C	31.1	0.61	94	145	C	25.8	0.63	84	143
Canal St NB (thru/right)	D	40.9	0.53	156	187	C	34.8	0.37	82	138	C	24.6	0.29	111	190
State Rd SB (left)	D	44.5	0.18	18	38	D	36.4	0.16	18	36	C	22.4	0.10	21	45
State Rd SB (thru/right)	D	49.6	0.36	35	109	D	40.6	0.27	23	69	C	33.1	0.60	168	#323
<b>23:: State Road / Route 3 NB On-Ramp</b>	A	4.4				A	3.4				A	3.1			
State Rd NB (left)	A	9.0	0.33	-	37	A	8.7	0.29	-	31	B	10.2	0.34	-	38
State Rd NB (thru)	A	0.0	0.13	-	0	A	0.0	0.23	-	0	A	0.0	0.14	-	0
State Rd SB (thru)	A	0.0	0.13	-	0	A	0.0	0.13	-	0	A	0.0	0.31	-	0
State Rd SB (right)	A	0.0	0.01	-	0	A	0.0	0.01	-	0	A	0.0	0.01	-	0
<b>24:: Cranberry Highway / Adams Street</b>	A	4.4				A	3.6				A	5.2			
Cranberry Highway EB (thru)	A	0.0	0.00	-	0	A	0.0	0.00	-	0	A	0.0	0.00	-	0
Cranberry Highway EB (thru/right)	A	0.0	0.00	-	0	A	0.0	0.00	-	0	A	0.0	0.00	-	0
Cranberry Highway WB (left/thru)	A	7.6	0.00	-	0	A	8.9	0.01	-	0	A	0.0	0.00	-	0
Cranberry Highway WB (thru)	A	0.0	0.00	-	0	A	0.0	0.00	-	0	A	0.0	0.00	-	0
Adams Street NB (left/thru/right)	B	10.6	0.07	-	6	C	15.0	0.06	-	7	A	9.6	0.04	-	3
Adams Street SB (left/thru/right)	B	11.0	0.30	-	32	B	13.2	0.43	-	55	C	17.1	0.58	-	93
<b>25:: Sandwich Road / Adams Street</b>	A	0.3				A	0.6				A	0.5			
Sandwich Rd EB (thru/right)	A	0.0	0.37	-	0	A	0.0	0.50	-	0	A	0.0	0.48	-	0
Sandwich Rd WB (left/thru)	A	0.7	0.03	-	2	A	1.0	0.03	-	2	A	1.0	0.04	-	3
<b>26:: Cranberry Highway / Sandwich Road / Regency Drive</b>	E	75.4				F	855.0				F	2370.9			
Sandwich Rd EB (left/thru/right)	A	0.0	0.00	-	0	A	0.0	0.00	-	0	A	8.5	0.01	-	0
Sandwich Rd WB (left/thru/right)	A	8.5	0.16	-	14	B	10.1	0.28	-	28	B	12.0	0.51	-	74
Cranberry Highway NB (left/thru)	F	403.7	1.68	-	368	F	3111.5	7.65	-	Err	F	\$12,573.2	27.78	-	Err
Cranberry Highway NB (right)	B	10.6	0.09	-	7	B	13.3	0.13	-	11	B	12.3	0.10	-	8
Regency Dr SB (left/thru/right)	A	0.0	0.00	-	0	F	78.7	0.11	-	8	B	11.8	0.02	-	1
<b>27:: Old King's Highway (Route 6A) / Main Street (Route 130) / Tupper Road</b>	B	10.7				E	38.0				F	363.3			
Old King's Hwy (Route 6A) EB (left/thru/right)	A	8.1	0.06	-	5	A	8.4	0.09	-	8	A	8.8	0.12	-	10
Old King's Hwy (Route 6A) WB (left/thru/right)	A	7.7	0.00	-	0	A	8.0	0.01	-	0	A	7.9	0.00	-	0
Main St (Route 130) NB (left/thru/right)	E	47.2	0.71	-	138	F	322.5	1.47	-	317	F	1686.4	4.51	-	Err
Tupper Rd SB (left/thru/right)	B	11.2	0.18	-	17	B	12.8	0.29	-	30	C	18.2	0.48	-	65
<b>28:: Old King's Highway (Route 6A) / Tupper Road</b>	C	31.9				E	58.6				F	215.5			
Old King's Hwy (Route 6A) EB (left)	C	23.0	0.03	2	13	C	23.1	0.03	2	12	B	19.7	0.05	4	19
Old King's Hwy (Route 6A) EB (thru/right)	C	26.5	0.46	75	171	D	40.2	0.82	191	299	C	25.3	0.54	168	317
Old King's Hwy (Route 6A) WB (left/thru)	C	33.9	0.73	132	253	F	106.9	1.07	~140	#323	D	41.6	0.85	222	#509
Old King's Hwy (Route 6A) WB (right)	C	23.9	0.16	12	55	C	23.8	0.12	6	47	C	21.5	0.25	39	119
Tupper Rd NB (left/thru/right)	D	37.0	0.77	121	#348	D	51.0	0.86	142	#358	F	476.0	1.94	~551	#696
Tupper Rd SB (left)	D	39.9	0.65	35	#149	F	93.1	0.96	76	#281	F	522.3	2.00	~210	#414
Tupper Rd SB (thru/right)	C	26.7	0.23	32	102	C	28.4	0.25	42	123	D	37.3	0.39	74	154

Table B-1: Synchro and SIDRA Results Summary - 2019 Existing Fall

Intersection	2019 Existing Fall AM					2019 Existing Fall PM					2019 Existing Fall MID				
	LOS	Delay (sec)	v/c Ratio	50% Queue (feet)	95% Queue (feet)	LOS	Delay (sec)	v/c Ratio	50% Queue (feet)	95% Queue (feet)	LOS	Delay (sec)	v/c Ratio	50% Queue (feet)	95% Queue (feet)
<b>29:: Water Street (Route 130) / Beale Avenue</b>															
Beale Ave WB (left/right)	D	32.6	0.62	-	98	A	1.5	0.21	-	19	F	123.8	1.00	-	196
Water St (Route 130) NB (thru/right)	A	0.0	0.00	-	0	A	0.0	0.00	-	0	A	0.0	0.00	-	0
Water St (Route 130) SB (left/thru)	A	8.6	0.01	-	1	A	8.3	0.01	-	1	B	10.6	0.05	-	4
<b>30:: Main Street / Beale Avenue</b>															
Main St EB (thru/right)	A	0.0	0.00	-	0	A	4.9	0.00	-	0	A	7.4	0.00	-	0
Main St WB (left/thru)	A	7.7	0.09	-	7	A	7.5	0.03	-	3	A	7.7	0.11	-	9
Beale Ave NB (left/right)	B	10.6	0.17	-	15	A	9.5	0.13	-	11	B	12.9	0.38	-	45
<b>31:: Old King's Highway (Route 6A) / Main Street / Old Main Street</b>															
Main St EB (left)	C	24.7	0.07	-	5	C	18.1	0.02	-	2	F	63.2	0.29	-	25
Main St EB (thru/right)	B	11.9	0.18	-	16	B	11.9	0.20	-	18	C	17.2	0.42	-	50
Old Main St WB (left/thru/right)	C	15.8	0.05	-	4	C	16.5	0.04	-	3	B	13.0	0.01	-	1
Old King's Hwy (Route 6A) NB (left/thru/right)	A	8.3	0.10	-	9	A	8.1	0.05	-	4	A	9.0	0.16	-	14
Old King's Hwy (Route 6A) SB (left/thru/right)	A	0.0	0.00	-	0	A	7.9	0.00	-	0	A	8.7	0.00	-	0
<b>32:: Forestdale Road (Route 130) / Route 6 EB Ramps</b>															
Route 6 EB Ramps EB (left)	C	21.0	-	-	-	E	63.7	-	-	-	F	104.0	-	-	-
Route 6 EB Ramps EB (right)	D	38.7	0.76	34	#129	F	161.5	1.29	~303	#487	F	430.4	1.84	~139	#305
Forestdale Rd (Route 130) NB (left)	A	6.6	0.33	16	33	A	7.9	0.36	14	28	B	11.4	0.32	6	13
Forestdale Rd (Route 130) NB (thru)	B	12.6	0.81	248	#525	B	18.4	0.84	233	92	A	8.6	0.76	165	261
Forestdale Rd (Route 130) SB (thru/right)	B	19.6	0.67	106	m164	C	21.6	0.85	92	m#364	D	38.8	0.99	~330	#438
<b>33:: Water Street (Route 130) / Route 6 WB Ramps</b>															
Route 6 WB Ramps EB (left)	D	35.4	0.71	59	105	D	47.6	0.86	101	#197	F	873.3	2.87	~590	#733
Route 6 WB Ramps EB (right)	A	0.1	0.10	0	0	A	0.1	0.10	0	0	A	0.1	0.08	0	0
Forestdale Rd (Route 130) NB (left)	C	33.6	0.86	157	m#210	D	37.3	0.93	143	m#218	C	23.1	0.60	61	94
Forestdale Rd (Route 130) NB (left)	C	33.6	0.86	157	m#210	D	37.3	0.93	143	m#218	C	23.1	0.60	61	94
Forestdale Rd (Route 130) NB (thru)	A	5.8	0.27	71	m115	A	8.3	0.28	69	m116	A	7.2	0.56	115	181
Forestdale Rd (Route 130) SB (thru)	D	36.9	0.88	~227	#276	C	31.0	0.83	192	#328	F	167.2	1.30	~370	#509
Forestdale Rd (Route 130) SB (right)	A	0.0	0.03	0	0	A	0.0	0.01	0	0	A	0.0	0.03	0	0
<b>34:: Quaker Meeting House Road / Route 6 EB Ramps</b>															
Route 6 EB Ramps EB (left/right)	F	134.6	4.51	-	331	B	12.1	0.87	-	218	C	22.0	1.07	-	266
Quaker Meetinghouse Rd NB (left/thru)	B	11.7	0.49	-	69	B	10.3	0.27	-	28	A	9.8	0.24	-	24
Quaker Meetinghouse Rd SB (thru/right)	A	0.0	0.00	-	0	A	0.0	0.00	-	0	A	0.0	0.00	-	0
<b>35:: Quaker Meeting House Road / Route 6 WB Ramps</b>															
Route 6 WB Ramps WB (left/right)	F	180.8	1.26	-	421	F	60.9	1.23	-	508	D	28.8	0.63	-	120
Quaker Meetinghouse Rd NB (thru/right)	A	0.0	0.00	-	0	A	0.0	0.00	-	0	A	0.0	0.00	-	0
Quaker Meetinghouse Rd SB (left/thru)	A	8.7	0.08	-	7	A	7.9	0.05	-	4	A	8.0	0.05	-	4
<b>36:: Route 130 / Cotuit Rd</b>															
Cotuit Rd WB (left)	A	0.0	0.00	-	0	B	13.8	1.42	-	41	F	133.3	0.16	-	12
Cotuit Rd WB (right)	E	49.5	0.94	-	309	D	26.6	0.71	-	143	F	57.4	0.96	-	313
Route 130 NB (thru/right)	A	0.0	0.00	-	0	A	0.0	0.00	-	0	A	0.0	0.00	-	0
Route 130 SB (left)	A	9.9	0.31	-	33	C	16.1	0.69	-	147	B	11.6	0.47	-	64
Route 130 SB (thru)	A	0.0	0.00	-	0	A	0.0	0.00	-	0	A	0.0	0.00	-	0
<b>37:: Nathan Ellis Highway (Route 151) / Route 28 NB Ramps</b>															
Nathan Ellis Hwy (Route 151) EB (left/thru)	A	9.0	0.12	-	10	A	8.8	0.14	-	12	A	8.2	0.07	-	5
Nathan Ellis Hwy (Route 151) WB (thru)	A	0.0	0.00	-	0	A	0.0	0.00	-	0	A	0.0	0.00	-	0
Nathan Ellis Hwy (Route 151) WB (right)	A	0.0	0.00	-	0	A	0.0	0.00	-	0	A	0.0	0.00	-	0
Route 28 NB Ramps SB (left/right)	D	29.8	0.32	-	38	F	663.2	2.27	-	464	F	83.4	0.93	-	231

**Table B-1: Synchro and SIDRA Results Summary - 2019 Existing Fall**

Intersection	2019 Existing Fall AM					2019 Existing Fall PM					2019 Existing Fall MID				
	LOS	Delay (sec)	v/c Ratio	50% Queue (feet)	95% Queue (feet)	LOS	Delay (sec)	v/c Ratio	50% Queue (feet)	95% Queue (feet)	LOS	Delay (sec)	v/c Ratio	50% Queue (feet)	95% Queue (feet)
<b>38:: Nathan Ellis Highway (Route 151) / Route 28 SB Ramps</b>	A	8.8				F	139.0				A	7.4			
Nathan Ellis Hwy (Route 151) EB (thru)	A	0.0	0.00	-	0	A	0.0	0.00	-	0	A	0.0	0.00	-	0
Nathan Ellis Hwy (Route 151) EB (right)	A	0.0	0.00	-	0	A	0.0	0.00	-	0	A	0.0	0.00	-	0
Nathan Ellis Hwy (Route 151) WB (left/thru)	A	9.0	0.17	-	15	A	8.7	0.09	-	7	A	8.2	0.06	-	5
Route 28 SB Ramps NB (left/right)	D	26.4	0.74	-	500	F	337.7	1.69	-	1295	C	20.7	0.72	-	372
<b>39:: Belmont Circle</b>	F	274.1				F	315.9				F	301.2			
Buzzards Bay Bypass (Route 6) EB (left/thru/right)	B	13.1	0.32	-	24	C	16.8	0.60	-	66	D	30.9	0.74	-	88
Main Street (Route 6) WB (left/thru)	A	9.3	0.35	-	29	C	21.9	0.72	-	109	C	17.8	0.61	-	72
Main Street (Route 6) WB (right)	F	472.0	2.01	-	6334	F	420.1	1.89	-	5143	F	464.6	1.98	-	5236
Old Bridge Road NB (left/thru/right)	B	10.1	0.02	-	1	A	9.1	0.01	-	1	B	10.7	0.02	-	1
Route 28/25 Ramps SB (left/thru/right)	F	241.7	1.49	-	151	F	490.3	2.05	-	6322	F	394.8	1.84	-	5797
Main Street NEB (left/thru/right)	F	226.5	1.43	-	2032	F	268.6	1.54	-	2963	F	256.1	1.5	-	2100
Head of the Bay Road SEB (left/thru/right)	F	74.5	1.03	-	425	C	18.0	0.57	-	57	F	101.6	1.11	-	672

**Legend**

~ : Volume exceeds capacity

\$ : Delay exceeds 300s

+ : Computation not defined

\* : All major volume in platoon

# : 95th percentile volume exceeds capacity; queue may be longer

m : Volume for 95th percentile queue is metered by upstream signal

Err : Error

dr : Defacto right lane

Table B-2: Synchro and SIDRA Results Summary - 2019 Existing Summer

Intersection	2019 Existing Summer AM					2019 Existing Summer PM					2019 Existing Summer MID				
	LOS	Delay (sec)	v/c Ratio	50% Queue (feet)	95% Queue (feet)	LOS	Delay (sec)	v/c Ratio	50% Queue (feet)	95% Queue (feet)	LOS	Delay (sec)	v/c Ratio	50% Queue (feet)	95% Queue (feet)
<b>1:: Maple Springs Rd / Route 25 NB On-Ramp</b>	A	0.1				A	0.0				A	0.2			
Maple Springs Rd NB (thru)	A	0.0	0.01	-	0	A	0.0	0.02	-	0	A	0.0	0.02	-	0
Maple Springs Rd NB (thru/right)	A	0.0	0.45	-	0	A	0.0	0.52	-	0	A	0.0	0.55	-	0
Maple Springs Rd SB (left/thru)	A	1.9	0.01	-	1	A	1.0	0.00	-	0	A	2.5	0.01	-	1
<b>2:: Maple Springs Rd / Route 25 SB Off-Ramp</b>	A	5.1				C	15.7				F	119.8			
Route 25 SB Off-Ramp EB (left)	B	11.3	0.01	-	83	B	12.4	0.02	-	363	F	12.6	0.01	-	1600
Route 25 SB Off-Ramp EB (right)	B	12.7	0.53	-	83	D	31.8	0.92	-	363	F	207.7	1.42	-	1600
Maple Springs Rd NB (thru)	A	0.0	0.00	-	0	A	0.0	0.00	-	0	A	0.0	0.00	-	0
Maple Springs Rd NB (thru)	A	0.0	0.00	-	0	A	0.0	0.00	-	0	A	0.0	0.00	-	0
Maple Springs Rd SB (thru)	A	0.0	0.00	-	0	A	0.0	0.00	-	0	A	0.0	0.00	-	0
<b>3:: Glen Charlie Road / Route 25 NB Off-Ramp</b>	A	3.8				A	4.8				A	2.0			
Route 25 NB Off-Ramp EB (left)	B	13.5	0.05	-	40	C	24.7	0.30	-	67	C	18.6	0.06	-	26
Route 25 NB Off-Ramp EB (right)	B	14.7	0.36	-	40	C	16.5	0.49	-	67	B	13.2	0.26	-	26
Glen Charlie Rd NB (thru)	A	0.0	0.00	-	0	A	0.0	0.00	-	0	A	0.0	0.00	-	0
Glen Charlie Rd SB (thru)	A	0.0	0.00	-	0	A	0.0	0.00	-	0	A	0.0	0.00	-	0
<b>4:: Glen Charlie Road / Route 25 SB On-Ramp</b>	A	0.8				A	0.6				A	0.5			
Glen Charlie Rd NB (thru)	A	0.0	0.08	-	0	A	0.0	0.32	-	0	A	0.0	0.32	-	0
Glen Charlie Rd NB (right)	A	0.0	0.06	-	0	A	0.0	0.11	-	0	A	0.0	0.07	-	0
Glen Charlie Rd SB (left/thru)	A	1.1	0.04	-	3	A	1.2	0.05	-	4	A	1.1	0.04	-	3
<b>5:: Buzzards Bay Rotary</b>	A	6.6				A	10.1				B				
Main Street (Route 6) EB (left)	A	7.0	0.34	-	31	A	9.2	0.49	-	56	B	13.2	0.66	-	106
Main Street (Route 6) EB (left/thru)	A	6.9	0.34	-	31	A	9.1	0.49	-	56	B	13.2	0.66	-	106
Main Street WB (thru/right)	A	6.7	0.28	-	22	A	12.6	0.59	-	74	C	16.8	0.69	-	105
Lincoln Avenue SB (left/thru/right)	A	6.1	0.11	-	7	A	8.7	0.16	-	11	A	8.2	0.21	-	15
Buzzards Bay Bypass (Route 6) SWB (left)	A	6.1	0.18	-	14	A	10.0	0.37	-	33	A	7.8	0.23	-	17
Buzzards Bay Bypass (Route 6) SWB (left/right)	A	6.0	0.18	-	13	A	9.8	0.37	-	31	A	7.5	0.23	-	17
<b>6:: Scenic Highway (Route 6) / Main Street (Route 6) / Nightingale Road / Andy Olivia Drive</b>	D	37.1				F	84.4				C	32.1			
Main Street (Route 6) EB (left/thru)	A	5.9	0.68	132	160	B	13.0	0.87	152	#321	A	8.9	0.67	134	171
Main Street (Route 6) EB (thru/right)	A	5.9	0.68	132	160	B	13.0	0.87	152	#321	A	8.9	0.67	134	171
Scenic Hwy (Route 6) WB (left/thru)	E	57.9	1.06	~667	#808	F	132.0	1.24	~917	#1106	D	44.7	1.00	~566	#748
Scenic Hwy (Route 6) WB (thru/right)	E	57.9	1.06	~667	#808	F	132.0	1.24	~917	#1106	D	44.7	1.00	~566	#748
Andy Olivia Dr NB (left/thru/right)	D	38.5	0.06	0	4	D	42.4	0.51	36	60	D	52.7	0.75	91	#150
Nightingale Pond Rd SB (left/thru)	D	39.4	0.26	18	39	D	39.8	0.14	9	30	D	35.5	0.06	6	22
Nightingale Pond Rd SB (right)	D	38.4	0.06	0	17	D	39.3	0.05	0	11	D	35.3	0.04	0	2
<b>7:: Sandwich Road / Trowbridge Road / County Road / Shore Road</b>	B	12.7				F	281.4				B	14.0			
Shore Rd EB (left/thru/right)	A	7.9	0.10	-	8	A	8.7	0.13	-	11	A	8.0	0.09	-	8
Trowbridge Rd WB (left/thru/right)	A	7.9	0.04	-	3	A	8.0	0.09	-	7	A	7.7	0.05	-	3
County Rd NB (left/thru/right)	D	29.7	0.62	-	97	F	969.9	3.03	-	1170	D	29.9	0.65	-	109
Sandwich Rd SB (left/thru/right)	D	33.8	0.52	-	70	F	Err	Err	-	Err	D	29.9	0.58	-	90
<b>8:: Trowbridge Rd./Veterans Way</b>	A	1.7				A	8.2				A	0.8			
Trowbridge Rd EB (left/thru/right)	A	7.7	0.04	-	3	A	7.9	0.05	-	4	A	7.8	0.00	-	0
Trowbridge Rd WB (left/thru/right)	A	0.0	0.00	-	0	A	0.0	0.00	-	0	A	0.0	0.00	-	0
Veterans Way NB (left/thru/right)	A	0.0	0.00	-	0	A	0.0	0.00	-	0	A	0.0	0.00	-	0
Driveway SB (left/thru/right)	B	13.1	0.09	-	7	D	34.1	0.66	-	107	B	11.8	0.06	-	5
<b>9:: Bourne Rotary</b>	F	491.7				F	579.5				F	787			
General MacArthur Boulevard NB (left/thru)	F	291.8	1.60	-	3671	F	814.3	2.76	-	8786	F	464.9	1.99	-	6148
General MacArthur Boulevard NB (right)	F	36.3	0.88	-	265	D	26.8	0.76	-	151	C	20.3	0.72	-	150
Sandwich Road WB (left/thru)	F	260.9	1.50	-	2140	C	18.2	0.54	-	67	F	83.2	1.03	-	463
Sandwich Road WB (right)	E	49.3	0.88	-	218	F	154.5	1.26	-	1358	F	188.9	1.34	-	1533
Route 28 (Bourne Bridge) SB (left/thru)	F	981.9	3.14	-	11966	F	774.2	2.68	-	11862	F	1442.5	4.17	-	17421
Route 28 (Bourne Bridge) SB (right)	A	6.2	0.03	-	2	A	4.7	0.04	-	3	A	6	0.05	-	4
Trowbridge Road EB (left/thru/right)	F	82.9	1.00	-	327	F	422.8	1.87	-	3287	E	40.9	0.8	-	129

Table B-2: Synchro and SIDRA Results Summary - 2019 Existing Summer

Intersection	2019 Existing Summer AM					2019 Existing Summer PM					2019 Existing Summer MID				
	LOS	Delay (sec)	v/c Ratio	50% Queue (feet)	95% Queue (feet)	LOS	Delay (sec)	v/c Ratio	50% Queue (feet)	95% Queue (feet)	LOS	Delay (sec)	v/c Ratio	50% Queue (feet)	95% Queue (feet)
<b>10:: Sandwich Road / Bourne Rotary Connector</b>															
Sandwich Rd EB (left/right)	F	86.0				F	568.8				F	147.7			
Bourne Rotary Connector NB (left/thru)	F	819.2	2.61	-	604	F	2553.5	6.50	-	Err	F	1540.8	4.12	-	Err
Sandwich Rd SB (thru/right)	B	10.2	0.01	-	1	B	10.3	0.01	-	1	B	10.8	0.03	-	2
Sandwich Rd SB (thru/right)	A	0.0	0.00	-	0	A	0.0	0.00	-	0	A	0.0	0.00	-	0
<b>11:: Sandwich Road / Upper Cape Cod Technical School Driveway</b>															
Cape Cod Technical School Driveway WB (left/right)	A	3.7				A	1.1				A	0.5			
Sandwich Rd NB (thru/right)	F	171.1	0.81	-	91	F	115.1	0.38	-	33	F	90.7	0.23	-	19
Sandwich Rd SB (left)	A	0.0	0.00	-	0	A	0.0	0.00	-	0	A	0.0	0.00	-	0
Sandwich Rd SB (thru)	B	11.9	0.03	-	2	C	15.2	0.14	-	12	B	12.2	0.01	-	1
Sandwich Rd SB (thru)	A	0.0	0.00	-	0	A	0.0	0.00	-	0	A	0.0	0.00	-	0
<b>12:: Sandwich Road / Harbor Lights Road</b>															
Harbor Lights Rd WB (left/right)	A	0.5				A	0.6				A	0.5			
Sandwich Rd NB (thru/right)	F	80.0	0.23	-	19	F	94.5	0.27	-	22	F	91.2	0.267	-	22
Sandwich Rd SB (left/thru)	A	0.0	0.00	-	0	A	0.0	0.00	-	0	A	0.0	0.00	-	0
Sandwich Rd SB (left/thru)	B	11.8	0.01	-	1	B	12.3	0.01	-	1	A	0.0	0.00	-	0
<b>13:: Sandwich Road / Jefferson Road (Tech Drive)</b>															
Jefferson Rd (Tech Dr) WB (left/right)	A	0.1				A	0.1				A	1.1			
Sandwich Rd NB (thru/right)	D	26.2	0.06	-	4	D	26.1	0.06	-	5	E	38.5	0.42	-	48
Sandwich Rd SB (left/thru)	A	0.0	0.00	-	0	A	0.0	0.00	-	0	A	0.0	0.00	-	0
Sandwich Rd SB (left/thru)	A	0.0	0.00	-	0	A	0.0	0.00	-	0	A	0.0	0.00	-	0
<b>14:: Sandwich Road / Jarvis Road</b>															
Jarvis Rd WB (left/right)	A	0.1				A	0.1				A	0.0			
Sandwich Rd NB (thru/right)	D	27.1	0.04	-	3	D	26.0	0.04	-	3	A	0.0	0.00	-	0
Sandwich Rd SB (left/thru)	A	0.0	0.00	-	0	A	0.0	0.00	-	0	A	0.0	0.00	-	0
Sandwich Rd SB (left/thru)	B	12.5	0.01	-	1	A	0.0	0.00	-	0	B	12.3	0.01	-	1
<b>15:: Sandwich Road (Route 6 Bypass) / Mid-Cape Connector</b>															
Sandwich Rd EB (thru)	B	10.8				B	11.2				A	7.9			
Sandwich Rd EB (right)	B	18.1	0.68	134	251	B	19.2	0.69	138	267	B	12.4	0.49	81	166
Sandwich Rd WB (left)	A	1.2	0.52	0	0	A	1.6	0.59	0	0	A	2.2	0.67	0	0
Sandwich Rd WB (thru)	A	6.9	0.07	4	14	A	7.3	0.16	10	27	A	4.2	0.11	7	22
Mid-Cape Connector NB (left)	B	11.6	0.72	175	321	B	11.6	0.72	180	354	A	8.2	0.71	156	346
Mid-Cape Connector NB (right)	C	23.2	0.65	88	213	C	23.8	0.67	94	222	C	21.4	0.52	38	116
Mid-Cape Connector SB (thru)	B	12.8	0.14	0	40	B	14.5	0.43	32	123	B	14.0	0.30	5	65
<b>16:: Mid-Cape Connector / Factory Outlet Way</b>															
Factory Outlet Way (Market Basket Driveway) WB (left)	B	10.4				B	10.2				A	8.5			
Factory Outlet Way (Market Basket Driveway) WB (left)	C	21.1	0.36	28	38	C	33.6	0.17	13	28	D	35.2	0.26	17	34
Factory Outlet Way (Market Basket Driveway) WB (right)	C	21.1	0.36	28	38	C	33.6	0.17	13	28	D	35.2	0.26	17	34
Factory Outlet Way (Market Basket Driveway) WB (right)	B	12.0	0.07	7	17	C	23.1	0.21	32	58	C	23.5	0.16	24	47
Mid-Cape Connector NB (thru)	B	14.7	0.64	141	247	B	14.4	0.65	232	421	B	10.9	0.49	152	237
Mid-Cape Connector NB (right)	A	4.9	0.05	0	9	A	4.4	0.04	0	9	A	4.5	0.04	0	8
Mid-Cape Connector SB (left)	C	25.1	0.17	7	28	D	35.6	0.34	26	58	D	35.6	0.38	29	63
Mid-Cape Connector SB (thru)	A	5.6	0.41	63	105	A	3.8	0.38	75	119	A	3.4	0.39	77	109
Mid-Cape Connector SB (thru)	A	5.6	0.41	63	105	A	3.8	0.38	75	119	A	3.4	0.39	77	109
<b>17:: Herring Pond Road / State Road</b>															
Herring Pond Rd EB (left/right)	D	33.4				F	432.8				F	302.8			
State Rd NB (left/thru)	F	69.4	0.99	-	691	F	905.0	2.93	-	Err	F	635.8	2.34	-	Err
State Rd SB (thru/right)	A	7.8	0.10	-	8	A	8.2	0.15	-	13	A	8.7	0.15	-	13
State Rd SB (thru/right)	A	0.0	0.00	-	0	A	0.0	0.00	-	0	A	0.0	0.00	-	0
<b>18:: Herring Pond Road / Route 3 NB Ramps</b>															
Route 3 NB Ramps EB (left/right)	A	3.9				F	61.3				C	17.3			
Herring Pond Rd NB (left/thru)	C	23.0	0.48	-	89	F	378.4	1.69	-	498	F	181.6	1.14	-	205
Herring Pond Rd SB (thru)	A	8.7	0.13	-	11	A	9.1	0.13	-	11	A	8.5	0.15	-	13
Herring Pond Rd SB (right)	A	0.0	0.00	-	0	A	0.0	0.00	-	0	A	0.0	0.00	-	0
Herring Pond Rd SB (right)	A	0.0	0.00	-	0	A	0.0	0.00	-	0	A	0.0	0.00	-	0
<b>19:: Herring Pond Road / Route 3 SB Ramps</b>															
Route 3 SB Ramps WB (left/right)	A	6.6				F	173.3				F	84.1			
Herring Pond Rd NB (thru/right)	C	15.9	0.48	-	177	F	478.6	1.98	-	1133	F	154.2	1.27	-	1129
Herring Pond Rd SB (left/thru)	A	0.0	0.00	-	0	A	CO	0.00	-	0	A	0.0	0.00	-	0
Herring Pond Rd SB (left/thru)	A	8.7	0.26	-	26	A	8.5	0.12	-	10	A	8.0	0.08	-	6

Table B-2: Synchro and SIDRA Results Summary - 2019 Existing Summer

Intersection	2019 Existing Summer AM					2019 Existing Summer PM					2019 Existing Summer MID				
	LOS	Delay (sec)	v/c Ratio	50% Queue (feet)	95% Queue (feet)	LOS	Delay (sec)	v/c Ratio	50% Queue (feet)	95% Queue (feet)	LOS	Delay (sec)	v/c Ratio	50% Queue (feet)	95% Queue (feet)
<b>20:: Scenic Highway (Route 6) / Church Lane / Route 6 SB On-Ramp</b>	C	20.3				B	19.4				D	51.5			
Scenic Hwy (Route 6) EB (left)	D	51.7	0.42	11	35	D	48.5	0.53	25	73	E	63.2	0.45	33	71
Scenic Hwy (Route 6) EB (thru)	C	24.1	0.89dr	262	441	C	23.9	0.73	250	458	E	61.3	1.31dr	473	#648
Scenic Hwy (Route 6) EB (thru/right)	C	24.1	0.89dr	262	441	C	23.9	0.73	250	458	E	61.3	1.31dr	473	#648
Scenic Hwy (Route 6) WB (left)	D	50.1	0.83	188	307	D	41.5	0.76	172	315	F	113.1	1.12	~725	#1004
Scenic Hwy (Route 6) WB (thru)	A	7.9	0.45	97	244	B	11.8	0.67	290	436	A	9.9	0.43	204	273
Scenic Hwy (Route 6) WB (thru)	A	7.9	0.45	97	244	B	11.8	0.67	290	436	A	9.9	0.43	204	273
Scenic Hwy (Route 6) WB (thru/right)	A	7.9	0.45	97	244	B	11.8	0.67	290	436	A	9.9	0.43	204	273
Church Lane SB (left/thru/right)	D	47.1	0.58	57	106	D	42.4	0.53	55	119	E	72.9	0.79	143	148
<b>21:: Scenic Highway (Route 6) &amp; Route 3 SB Off-Ramp</b>	B	16.4				D	40.8				C	20.3			
Scenic Hwy (Route 6) EB (thru)	B	9.1	0.46	146	238	B	10.7	0.47	206	285	A	7.9	0.31	110	153
Scenic Hwy (Route 6) WB (thru)	B	13.9	0.77	333	482	C	29.2	0.95	777	801	B	17.5	0.85	566	736
Scenic Hwy (Route 6) WB (thru)	B	13.9	0.77	333	482	C	29.2	0.95	777	801	B	17.5	0.85	566	736
Route 3 Off-Ramp SB (left/right)	D	41.0	0.76	154	#331	F	135.0	1.14	~413	#623	D	52.6	0.81	223	#352
<b>22:: Meetinghouse Lane / State Road / Canal Street</b>	D	46.4				E	78.0				D	49.1			
Meetinghouse Ln EB (left)	C	27.2	0.64	165	#501	E	67.8	1.01	283	#754	D	52.7	0.83	130	#209
Meetinghouse Ln EB (thru)	B	19.5	0.26	82	217	C	31.7	0.68	230	#574	E	64.6	0.86	271	#408
Meetinghouse Ln EB (right)	B	19.3	0.23	0	77	C	20.3	0.05	0	0	D	38.2	0.16	0	54
Meetinghouse Ln WB (left)	C	33.7	0.09	8	34	D	35.6	0.15	8	31	D	41.7	0.26	19	41
Meetinghouse Ln WB (thru/right)	F	105.3	1.04	259	#522	F	271.0	1.45	~236	#400	F	124.7	1.06	213	#324
Canal St NB (left)	D	41.4	0.74	160	181	C	34.0	0.77	127	#186	C	21.4	0.62	74	176
Canal St NB (thru/right)	D	43.9	0.64	187	218	C	29.7	0.43	115	165	B	19.8	0.29	101	233
State Rd SB (left)	D	45.1	0.13	13	29	C	32.8	0.14	14	34	B	18.3	0.11	19	58
State Rd SB (thru/right)	D	49.4	0.25	17	80	D	43.1	0.64	93	159	C	30.9	0.67	230	#645
<b>23:: State Road / Route 3 NB On-Ramp</b>	A	4.3				A	3.7				A	3.1			
State Rd NB (left)	A	8.9	0.31	-	33	A	9.5	0.37	-	100	B	10.9	0.34	-	38
State Rd NB (thru)	A	0.0	0.13	-	0	A	0.0	0.24	-	0	A	0.0	0.08	-	0
State Rd SB (thru)	A	0.0	0.12	-	0	A	0.0	0.18	-	0	A	0.0	0.39	-	0
State Rd SB (right)	A	0.0	0.00	-	0	A	0.0	0.00	-	0	A	0.0	0.01	-	0
<b>24:: Cranberry Highway / Adams Street</b>	A	3.2				A	3.5				A	2.5			
Cranberry Highway EB (thru)	A	0.0	0.00	-	0	A	0.0	0.00	-	0	A	0.0	0.00	-	0
Cranberry Highway EB (thru/right)	A	0.0	0.00	-	0	A	0.0	0.00	-	0	A	0.0	0.00	-	0
Cranberry Highway WB (left/thru)	A	9.2	0.01	-	0	A	8.5	0.01	-	0	A	7.9	0.00	-	0
Cranberry Highway WB (thru)	A	0.0	0.00	-	0	A	0.0	0.00	-	0	A	0.0	0.00	-	0
Adams Street NB (left/thru/right)	A	0.0	0.00	-	0	B	10.0	0.02	-	1	B	12.5	0.06	-	5
Adams Street SB (left/thru/right)	B	11.3	0.32	-	35	B	13.6	0.43	-	54	B	12.5	0.28	-	28
<b>25:: Sandwich Road / Adams Street</b>	A	0.3				A	0.2				A	0.3			
Sandwich Rd EB (thru/right)	A	0.0	0.42	-	0	A	0.0	0.52	-	0	A	0.0	0.41	-	0
Sandwich Rd WB (left/thru)	A	0.5	0.02	-	2	A	0.4	0.01	-	1	A	0.6	0.02	-	1
<b>26:: Cranberry Highway / Sandwich Road / Regency Drive</b>	F	498.4				F	1019.7				A	4.4			
Sandwich Rd EB (left/thru/right)	A	7.7	0.00	-	0	A	8.2	0.01	-	0	A	8.8	0.01	-	0
Sandwich Rd WB (left/thru/right)	A	9.8	0.33	-	36	B	10.5	0.38	-	44	C	15.2	0.65	-	127
Cranberry Highway NB (left/thru)	F	1863.3	4.91	-	Err	F	4523.4	10.63	-	Err	A	0.0	0.00	-	Err
Cranberry Highway NB (right)	B	11.1	0.05	-	4	B	13.1	0.18	-	16	B	13.2	0.13	-	11
Regency Dr SB (left/thru/right)	D	29.5	0.08	-	7	A	0.0	0.00	-	0	A	0.0	0.00	-	1
<b>27:: Old King's Highway (Route 6A) / Main Street (Route 130) / Tupper Road</b>	F	91.1				A	5.1				F	2211.3			
Old King's Hwy (Route 6A) EB (left/thru/right)	A	9.1	0.30	-	31	A	8.5	0.11	-	9	B	10.0	0.15	-	13
Old King's Hwy (Route 6A) WB (left/thru/right)	A	7.5	0.00	-	0	A	8.1	0.01	-	1	A	8.0	0.01	-	0
Main St (Route 130) NB (left/thru/right)	F	635.8	2.13	-	393	C	15.4	0.16	-	15	F	13382.0	29.39	-	Err
Tupper Rd SB (left/thru/right)	B	12.6	0.23	-	21	C	17.3	0.47	-	63	F	68.8	0.94	-	241
<b>28:: Old King's Highway (Route 6A) / Tupper Road</b>	D	39.4				F	239.7				F	143.9			
Old King's Hwy (Route 6A) EB (left)	C	25.3	0.05	2	12	B	19.7	0.02	2	12	C	20.4	0.11	6	28
Old King's Hwy (Route 6A) EB (thru/right)	C	32.6	0.64	102	191	C	29.4	0.69	225	436	C	30.2	0.72	245	#493
Old King's Hwy (Route 6A) WB (left/thru)	D	41.7	0.79	111	234	C	33.4	0.75	184	#416	F	162.8	1.25	~409	#767
Old King's Hwy (Route 6A) WB (right)	C	25.9	0.15	6	57	C	22.0	0.27	37	123	C	24.7	0.51	106	263
Tupper Rd NB (left/thru/right)	D	54.9	0.91	140	#380	F	480.1	1.95	~568	#949	F	208.6	1.32	~302	#601
Tupper Rd SB (left)	D	37.8	0.67	43	#165	F	858.5	2.74	~217	#424	F	548.0	2.06	~227	#449
Tupper Rd SB (thru/right)	C	24.5	0.20	31	94	D	37.7	0.50	98	200	D	39.0	0.52	102	207

**Table B-2: Synchro and SIDRA Results Summary - 2019 Existing Summer**

Intersection	2019 Existing Summer AM					2019 Existing Summer PM					2019 Existing Summer MID				
	LOS	Delay (sec)	v/c Ratio	50% Queue (feet)	95% Queue (feet)	LOS	Delay (sec)	v/c Ratio	50% Queue (feet)	95% Queue (feet)	LOS	Delay (sec)	v/c Ratio	50% Queue (feet)	95% Queue (feet)
<b>29:: Water Street (Route 130) / Beale Avenue</b>															
Water St (Route 130) NB (thru/right)	A	3.1				A	1.8				A	4.8			
Beale Ave WB (left/right)	C	23.1	0.41	-	48	C	21.6	0.29	-	29	F	71.5	0.70	-	100
Water St (Route 130) SB (left/thru)	A	8.7	0.01	-	0	A	8.7	0.01	-	1	A	9.9	0.02	-	2
<b>30:: Main Street / Beale Avenue</b>															
Main St EB (thru/right)	A	5.1				A	4.6				A	3.7			
Main St WB (left/thru)	A	0.0	0.00	-	0	A	0.0	0.00	-	0	A	0.0	0.00	-	0
Beale Ave NB (left/right)	A	7.5	0.06	-	5	A	7.5	0.03	-	3	A	7.6	0.06	-	4
	A	9.7	0.08	-	7	A	9.5	0.12	-	10	B	10.4	0.14	-	12
<b>31:: Old King's Highway (Route 6A) / Main Street / Old Main Street</b>															
Main St EB (left)	A	2.4				A	2.8				A	4.8			
Main St EB (thru/right)	C	20.3	0.03	-	2	E	37.9	0.10	-	7	F	198.6	0.64	-	51
Old Main St WB (left/thru/right)	B	10.0	0.10	-	8	C	17.7	0.32	-	34	C	15.4	0.30	-	32
Old King's Hwy (Route 6A) NB (left/thru/right)	B	14.5	0.04	-	4	C	21.6	0.05	-	4	E	40.5	0.16	-	11
Old King's Hwy (Route 6A) SB (left/thru/right)	A	7.9	0.07	-	6	A	9.3	0.08	-	7	A	9.4	0.14	-	12
	A	8.1	0.01	-	0	A	8.3	0.00	-	0	A	0.0	0.00	-	0
<b>32:: Forestdale Road (Route 130) / Route 6 EB Ramps</b>															
Route 6 EB Ramps EB (left)	C	21.4				D	54.6				B	13.9			
Route 6 EB Ramps EB (right)	C	24.8	0.25	22	45	C	21.7	0.21	26	53	C	22.3	0.38	19	51
Forestdale Rd (Route 130) NB (left)	D	35.4	0.72	33	#119	F	155.2	1.23	~199	#295	C	22.1	0.33	0	#76
Forestdale Rd (Route 130) NB (thru)	A	6.5	0.22	11	23	B	11.0	0.42	13	28	A	4.0	0.16	7	15
Forestdale Rd (Route 130) SB (thru/right)	B	18.0	0.89	318	#601	B	15.4	0.83	229	390	B	11.8	0.83	183	336
	B	16.8	0.69	99	195	C	22.1	0.89	105	m126	A	9.2	0.48	82	144
<b>33:: Water Street (Route 130) / Route 6 WB Ramps</b>															
Route 6 WB Ramps EB (left)	C	19.3				C	34.6				B	19.5			
Route 6 WB Ramps EB (right)	D	36.9	0.71	53	103	E	60.1	0.92	99	#216	D	35.8	0.82	97	#220
Forestdale Rd (Route 130) NB (left)	A	0.1	0.09	0	0	A	0.0	0.04	0	0	A	0.0	0.02	0	0
Forestdale Rd (Route 130) NB (left)	C	26.8	0.81	137	m156	C	34.2	0.89	130	m#193	C	22.0	0.58	63	93
Forestdale Rd (Route 130) NB (thru)	C	26.8	0.81	137	m156	C	34.2	0.89	130	m#193	C	22.0	0.58	63	93
Forestdale Rd (Route 130) SB (thru)	A	6.5	0.38	121	m145	A	7.1	0.31	74	m130	A	9.3	0.68	150	221
Forestdale Rd (Route 130) SB (right)	C	24.0	0.70	168	#305	D	46.5	0.96	251	#440	C	26.8	0.82	142	#275
	A	0.0	0.02	0	0	A	0.0	0.02	0	0	A	0.0	0.02	0	0
<b>34:: Quaker Meeting House Road / Route 6 EB Ramps</b>															
Route 6 EB Ramps EB (left/right)	F	191.7				F	67.3				E	46.9			
Quaker Meetinghouse Rd NB (left/thru)	F	611.1	2.24	-	873	F	426.8	1.76	-	435	F	275.1	1.44	-	411
Quaker Meetinghouse Rd SB (left/thru)	A	9.1	0.33	-	36	B	11.0	0.36	-	41	B	10.1	0.25	-	24
	A	0.0	0.00	-	0	A	0.0	0.00	-	0	A	0.0	0.00	-	0
<b>35:: Quaker Meeting House Road / Route 6 WB Ramps</b>															
Route 6 WB Ramps WB (left/right)	A	2.4				E	45.8				E	47.6			
Quaker Meetinghouse Rd NB (thru/right)	B	12.3	0.21	-	29	F	131.8	1.16	-	413	F	125.0	1.16	-	498
Quaker Meetinghouse Rd SB (left/thru)	A	0.0	0.00	-	0	A	0.0	0.00	-	0	A	0.0	0.00	-	0
	A	8.2	0.03	-	3	A	7.9	0.04	-	3	A	8.1	0.02	-	1
<b>36:: Route 130 / Cotuit Rd</b>															
Cotuit Rd WB (left)	C	22.5				F	54.1				D	30.5			
Cotuit Rd WB (right)	F	63.0	0.09	-	7	F	2225.1	4.30	-	Err	F	98.8	0.23	-	19
Route 130 NB (thru/right)	F	74.8	1.02	-	364	F	52.3	0.92	-	271	F	104.3	1.11	-	432
Route 130 SB (left)	A	0.0	0.00	-	0	A	0.0	0.00	-	0	A	0.0	0.00	-	0
Route 130 SB (thru)	B	10.8	0.35	-	39	C	15.2	0.64	-	121	B	11.8	0.43	-	56
	A	0.0	0.00	-	0	A	0.0	0.00	-	0	A	0.0	0.00	-	0
<b>37:: Nathan Ellis Highway (Route 151) / Route 28 NB Ramps</b>															
Nathan Ellis Hwy (Route 151) EB (left/thru)	A	2.0				F	458.3				F	65.8			
Nathan Ellis Hwy (Route 151) WB (thru)	A	8.9	0.11	-	9	A	9.3	0.17	-	15	A	9.5	0.16	-	14
Nathan Ellis Hwy (Route 151) SB (left/thru)	A	0.0	0.00	-	0	A	0.0	0.00	-	0	A	0.0	0.00	-	0
Nathan Ellis Hwy (Route 151) SB (right)	A	0.0	0.00	-	0	A	0.0	0.00	-	0	A	0.0	0.00	-	0
Route 28 NB Ramps SB (left/right)	C	20.5	0.35	-	60	F	4153.4	9.70	-	Err	F	\$685.2	2.29	-	433

**Table B-2: Synchro and SIDRA Results Summary - 2019 Existing Summer**

Intersection	2019 Existing Summer AM					2019 Existing Summer PM					2019 Existing Summer MID				
	LOS	Delay (sec)	v/c Ratio	50% Queue (feet)	95% Queue (feet)	LOS	Delay (sec)	v/c Ratio	50% Queue (feet)	95% Queue (feet)	LOS	Delay (sec)	v/c Ratio	50% Queue (feet)	95% Queue (feet)
<b>38:: Nathan Ellis Highway (Route 151) / Route 28 SB Ramps</b>	A	5.6				F	324.9				F	93.1			
Nathan Ellis Hwy (Route 151) EB (thru)	A	0.0	0.00	-	0	A	0.0	0.00	-	0	A	0.0	0.00	-	0
Nathan Ellis Hwy (Route 151) EB (right)	A	0.0	0.00	-	0	A	0.0	0.00	-	0	A	0.0	0.00	-	0
Nathan Ellis Hwy (Route 151) WB (left/thru)	A	8.6	0.13	-	11	A	9.6	0.10	-	9	A	9.0	0.09	-	7
Route 28 SB Ramps NB (left/right)	C	19.7	0.61	-	293	F	888.7	2.90	-	1999	F	343.3	1.67	-	1023
<b>39:: Belmont Circle</b>	F	274.9				F	401.3				F	223.7			
Buzzards Bay Bypass (Route 6) EB (left/thru/right)	B	13.7	0.41	-	34	C	17.2	0.57	-	58	F	180.9	1.31	-	1262
Main Street (Route 6) WB (left/thru)	C	18.4	0.70	-	112	D	25.5	0.83	-	196	D	28.4	0.83	-	179
Main Street (Route 6) WB (right)	F	389.0	1.82	-	5539	F	481.5	2.03	-	7396	F	279.8	1.57	-	3757
Old Bridge Road NB (left/thru/right)	A	0.0	0.01	-	1	A	8.0	0.01	-	1	A	8.2	0.01	-	1
Route 28/25 Ramps SB (left/thru/right)	F	359.0	1.75	-	4645	F	711.4	2.54	-	8095	F	113.5	1.17	-	1242
Main Street NEB (left/thru/right)	F	243.7	1.49	-	3359	F	228.8	1.46	-	3360	F	379.7	1.8	-	5277
Head of the Bay Road SEB (left/thru/right)	B	12.5	0.31	-	23	B	11.7	0.27	-	19	C	18.6	0.51	-	45

Legend

~ : Volume exceeds capacity

\$ : Delay exceeds 300s

+ : Computation not defined

\* : All major volume in platoon

# : 95th percentile volume exceeds capacity; queue may be longer

m : Volume for 95th percentile queue is metered by upstream signal

Err : Error

dr : Defacto right lane



VISSIM

**Table B-3: INRIX vs. VISSIM Travel Time Comparison**

				Travel Time (min)												
				Fall						Summer						
From	To	Start Point	End point	Weekday AM		Weekday PM		Saturday MID		Weekday AM		Weekday PM		Saturday MID		
				INRIX	VISSIM	INRIX	VISSIM	INRIX	VISSIM	INRIX	VISSIM	INRIX	VISSIM	INRIX	VISSIM	
Bourne Bridge	Route 28		Route 28 SB at Clay Pond Road	10.9	7.3	14.6	10.1	10.4	7.5	10.9	6.0	18.8	13.9	24.1	19.5	
	Route 25 SB	Scenic Highway (Route 6)	Route 25 SB at Plymouth Lane Overpass	11.8	8.7	15.2	11.6	12.0	8.9	11.6	7.5	24.5	16.2	28.0	18.4	
		Bourne Bridge		End of Bourne Bridge SB	8.7	4.6	12.6	7.5	8.3	4.8	8.8	3.9	16.8	10.9	21.9	16.1
		Sagamore Bridge		End of Sagamore Bridge SB (via Scenic Highway)	13.0	10.5	16.5	13.3	13.3	10.7	12.9	9.2	27.7	19.0	31.4	23.3
		Belmont Circle Off-Ramp		End of the Route 25/28 Off Ramp	5.2	5.7	14.7	12.9	6.8	8.7	4.6	5.6	11.4	11.3	7.1	7.6
		Sandwich Road		Sandwich Road at Mid-Cape Connector	7.7	6.5	17.6	14.4	9.0	9.4	6.5	6.2	14.7	13.7	10.3	11.0
		Route 28 NB	Sagamore Bridge	Route 28 NB at Clay Pond Road	9.6	9.0	19.5	17.1	10.9	12.1	8.4	8.8	16.6	16.5	12.5	16.1
		Route 25		Route 25 NB at Plymouth Lane Overpass	10.1	6.4	19.5	15.7	11.3	9.4	9.3	6.9	16.0	12.0	11.6	7.9
		Bourne Bridge		End of Bourne Bridge NB	4.0	3.7	13.5	10.6	5.6	6.6	3.4	3.5	10.2	9.2	5.9	5.1
	Sagamore Bridge		Off-Ramp to Scenic Highway		End of Off-Ramp to Scenic Highway	2.7	3.4	2.7	2.5	3.9	3.4	2.7	2.6	11.2	5.9	12.1
		Off-Ramp to Mid-Cape Connector		End of Off-Ramp to Mid-Cape Connector	4.0	6.5	4.1	4.9	5.2	6.6	4.0	4.8	12.9	12.1	14.2	10.9
Route 3 SB		Route 6	Route 3 SB south of Herring Pond Road	6.8	8.4	6.8	6.7	8.0	8.6	6.8	6.4	16.0	15.5	17.8	14.5	
		Bourne Bridge		End of Bourne Bridge SB (via Scenic Highway)	10.9	11.4	11.5	10.2	10.9	11.7	10.6	10.8	27.4	19.3	29.2	19.4
		Sagamore Bridge		End of Sagamore Bridge SB	3.0	5.5	3.0	3.7	4.2	5.6	3.0	3.9	11.7	10.7	12.8	9.6
		Off-Ramp to Cranberry Highway		End of Off-Ramp to Cranberry Highway	3.8	3.1	5.0	3.5	3.6	3.1	3.8	3.4	3.7	3.6	8.0	5.6
Route 6 E NB		Off-Ramp to Scenic Highway WB	Route 6 E NB north of Route 130	End of Off-Ramp to Scenic Highway	4.5	4.8	5.8	5.5	4.3	4.8	4.5	5.3	4.5	5.6	9.4	9.6
		Route 3		Route 3 NB south of Herring Pond Road	6.4	6.2	7.6	6.8	6.1	6.2	6.4	7.0	6.3	7.3	11.3	10.6

Note: Route 6 E = Route 6 east/south of Sagamore Bridge

**Table B-4: VISSIM Speed Summary**

<u>Name</u>	<u>Start Point</u>	<u>End Point</u>	<u>Speed (mph)</u>					
			<u>Fall</u>			<u>Summer</u>		
			<u>Weekday</u> <u>AM</u>	<u>Weekday</u> <u>PM</u>	<u>Saturday</u> <u>MID</u>	<u>Weekday</u> <u>AM</u>	<u>Weekday</u> <u>PM</u>	<u>Saturday</u> <u>MID</u>
Route 25 SB	Route 25 SB at Plymouth Lane Overpass	Off-Ramp diverge to Belmont Circle	50	23	50	60	16	12
Route 25 NB	On-Ramp merge from Belmont Circle	Route 25 NB at Plymouth Lane Overpass	60	27	60	46	60	60
Bourne Bridge SB	On-Ramp merge from Belmont Circle	Bourne Rotary	25	26	23	28	17	13
Bourne Bridge NB	Bourne Rotary	Off-Ramp diverge to Belmont Circle	42	37	42	43	42	42
Route 28 SB	Bourne Rotary	Route 28 SB at Clay Pond Road	41	42	42	54	37	33
Route 28 NB	Route 28 NB at Clay Pond Road	Bourne Rotary	41	12	21	42	13	28
Scenic Highway EB	Belmont Circle	Off-Ramp to Sagamore Bridge	37	38	37	43	29	28
Scenic Highway WB	Off-Ramp to Sagamore Bridge	Belmont Circle	36	38	35	33	23	28
Sandwich Road EB	Bourne Rotary	Mid-Cape Connector	43	33	44	46	35	30
Sandwich Road WB	Mid-Cape Connector	Bourne Rotary	30	20	30	31	32	16
Route 3 SB	Route 3 SB south of Herring Pond Road	Off-Ramp diverge to Scenic Highway	28	38	28	38	15	15
Route 3 NB	On-Ramp merge from State Road	Route 3 NB south of Herring Pond Road	50	51	51	42	42	42
Sagamore Bridge SB	On-Ramp merge from Scenic Highway	Off-Ramp diverge to Mid-Cape Connector	32	36	32	35	18	18
Sagamore Bridge NB	On-Ramp merge from Cranberry Highway	Off-Ramp diverge to Meetinghouse Lane	36	32	36	33	31	20
Route 6 E SB	On-Ramp merge from Mid-Cape Connector	Route 6 E SB north of Route 130	44	43	42	49	26	25
Route 6 E NB	Route 6 E NB north of Route 130	Off-Ramp diverge to Cranberry Highway	41	35	41	37	35	21

**Table B-5: VISSIM Processed Volumes Summary and Comparison with Volumes from Flow Maps**

From Location/Movement		Processed Volume																		
		Fall									Summer									
		Weekday AM			Weekday PM			Saturday MID			Weekday AM			Weekday PM			Saturday MID			
Flow Maps	VISSIM	% Processed	Flow Maps	VISSIM	% Processed	Flow Maps	VISSIM	% Processed	Flow Maps	VISSIM	% Processed	Flow Maps	VISSIM	% Processed	Flow Maps	VISSIM	% Processed	Flow Maps	VISSIM	% Processed
<b>Buzzards Bay Rotary</b>																				
Main Street (Route 6) EB	Approach west of BB Rotary	675	673	99.8%	580	577	99.6%	880	1025	116.5%	640	689	107.6%	970	964	99.4%	1310	1309	99.9%	
Main Street (Route 6) WB	West of BB Rotary	430	412	95.7%	755	748	99.1%	905	744	82.3%	495	461	93.1%	920	843	91.6%	760	647	85.1%	
Main Street WB	Approach east of BB Rotary	180	159	88.2%	340	308	90.6%	625	432	69.1%	220	189	86.0%	475	426	89.7%	485	423	87.1%	
Buzzards Bay Bypass (Route 6) SWB		285	292	102.5%	520	566	108.8%	365	388	106.3%	295	299	101.3%	485	468	96.6%	315	251	79.5%	
Lincoln Avenue SB		65	67	102.7%	65	67	102.7%	105	107	102.0%	70	73	103.6%	80	82	103.0%	120	123	102.6%	
<b>Belmont Circle</b>																				
Buzzards Bay Bypass (Route 6) EB		135	183	135.7%	340	372	109.5%	310	351	113.2%	195	194	99.4%	295	302	102.3%	440	358	81.3%	
Belmont Circle WB	Thru	240	292	121.7%	550	566	102.8%	405	388	95.8%	305	299	98.0%	500	468	93.7%	255	251	98.3%	
Route 25/28 Ramps SB		1185	1136	95.8%	1350	1279	94.7%	1365	1310	96.0%	1165	1127	96.7%	1480	1399	94.6%	1080	973	90.1%	
Belmont Circle NB	Thru to the ramps	1915	1813	94.7%	1770	1657	93.6%	1925	1789	93.0%	1795	1734	96.6%	1950	1687	86.5%	1850	1471	79.5%	
Main Street (Route 6) WB		1605	1501	93.5%	1630	1496	91.7%	1495	1383	92.5%	1815	1705	93.9%	2195	1903	86.7%	1740	1486	85.4%	
Main Street NEB	Thru	700	726	103.7%	895	904	101.0%	665	732	110.0%	1060	1180	111.3%	1095	1062	97.0%	1075	1059	98.5%	
Belmont Circle EB	Thru	1290	1294	100.3%	1135	1120	98.7%	1275	1208	94.8%	1115	1183	106.1%	1335	1264	94.7%	1050	904	86.1%	
<b>North of Bourne Bridge - Route 25 Ramps</b>																				
Route 25 SB	Approach before Exit 10	1845	1831	99.2%	1755	1721	98.1%	1915	2059	107.5%	1880	1871	99.5%	2370	2592	109.4%	2285	2786	121.9%	
Route 25 SB Off-Ramp to Belmont Circle		715	695	97.2%	700	659	94.1%	760	791	104.0%	650	632	97.2%	780	811	104.0%	685	592	86.4%	
Route 25 SB On-Ramp from Belmont Circle		760	714	93.9%	700	651	93.0%	1025	832	81.1%	700	673	96.2%	595	512	86.1%	1040	822	79.0%	
Route 25 NB Off-Ramp to Belmont Circle		470	445	94.6%	650	630	96.9%	605	526	87.0%	515	501	97.3%	700	597	85.2%	395	392	99.3%	
Route 25 NB On-Ramp from Belmont Circle		1155	1090	94.4%	1070	999	93.4%	900	950	105.6%	1095	1055	96.3%	1355	1163	85.8%	810	638	78.7%	
Route 25 NB	After On-Ramp from Belmont Circle	1910	1787	93.6%	2230	2054	92.1%	1820	1729	95.0%	1935	1837	94.9%	2645	2224	84.1%	2260	2049	90.7%	
<b>Bourne Bridge</b>																				
Bourne Bridge SB		1890	1804	95.4%	1755	1639	93.4%	2180	2048	94.0%	1930	1871	96.9%	2185	2123	97.2%	2640	2353	89.1%	
Bourne Bridge NB		1225	1178	96.1%	1810	1755	97.0%	1525	1328	87.1%	1355	1325	97.8%	1990	1689	84.9%	1845	1839	99.6%	
<b>South of Bourne Bridge - Bourne Rotary</b>																				
Bourne Bridge SB		1890	1804	95.4%	1755	1639	93.4%	2180	2048	94.0%	1930	1871	96.9%	2185	2123	97.2%	2640	2353	89.1%	
Trowbridge Road EB		350	338	96.5%	415	422	101.7%	305	296	97.0%	295	281	95.4%	510	412	80.7%	230	237	103.1%	
Trowbridge Road WB	West of Bourne Rotary	285	261	91.6%	215	181	84.2%	455	403	88.5%	145	138	95.3%	235	204	86.6%	265	211	79.5%	
Route 28 NB		1435	1410	98.2%	1305	1503	115.2%	1545	1475	95.5%	1325	1310	98.9%	1580	1537	97.3%	1680	1838	109.4%	
Route 28 SB	South of Bourne Rotary	1890	1753	92.7%	1335	1198	89.7%	1560	1479	94.8%	1925	1837	95.4%	1610	1464	90.9%	2195	1892	86.2%	
Sandwich Road WB		670	633	94.4%	970	776	79.9%	725	783	107.9%	1050	1056	100.6%	845	785	92.9%	1005	825	82.1%	
Sandwich Road EB	East of Bourne Rotary	945	897	95.0%	1085	980	90.3%	1215	1084	89.2%	1175	1127	95.9%	1285	1091	84.9%	1250	1116	89.3%	
<b>Between Bourne and Sagamore Bridges</b>																				
Scenic Highway EB		1270	1248	98.2%	1060	1027	96.9%	1190	1115	93.7%	1090	1141	104.7%	1215	1123	92.4%	930	788	84.7%	
Scenic Highway WB		1550	1450	93.6%	1520	1493	98.2%	1330	1324	99.6%	1405	1637	116.5%	1885	1950	103.4%	1425	1381	96.9%	
Sandwich Road EB		940	1031	109.6%	1085	1054	97.1%	1205	1162	96.4%	1170	1198	102.4%	1280	1227	95.9%	1235	1192	96.5%	
Sandwich Road WB		775	774	99.9%	1030	1126	109.3%	680	810	119.1%	935	1038	111.0%	1035	1039	100.4%	935	983	105.1%	
<b>Scenic Highway (Route 6) / Church Lane</b>																				
Scenic Highway (Route 6) EB	Thru	435	421	96.7%	520	496	95.3%	330	320	96.9%	415	425	102.5%	475	451	94.9%	275	226	82.1%	
Scenic Highway (Route 6) EB	Right	865	828	95.7%	630	597	94.7%	745	727	97.6%	680	699	102.8%	630	597	94.8%	805	649	80.7%	
Scenic Highway (Route 6) WB	Left	296	302	102.0%	245	250	101.9%	340	350	103.0%	290	293	100.9%	290	290	100.2%	725	601	82.9%	
Scenic Highway (Route 6) WB	Thru	1500	1433	95.6%	1485	1414	95.2%	1285	1237	96.3%	1345	1310	97.4%	1860	1780	95.7%	1410	1227	87.0%	
<b>Scenic Highway (Route 6) / Route 3 SB Off-Ramp</b>																				
Route 3 SB Off-Ramp SB	Left	115	114	99.1%	160	156	97.5%	120	115	96.0%	75	74	99.0%	60	61	101.5%	65	82	126.1%	
Route 3 SB Off-Ramp SB	Right	265	253	95.6%	310	294	94.9%	380	356	93.7%	220	213	96.7%	355	364	102.4%	235	294	125.3%	

**Table B-5: VISSIM Processed Volumes Summary and Comparison with Volumes from Flow Maps**

From		Location/Movement		Processed Volume																	
				Fall									Summer								
				Weekday AM			Weekday PM			Saturday MID			Weekday AM			Weekday PM			Saturday MID		
Flow Maps	VISSIM	% Processed	Flow Maps	VISSIM	% Processed	Flow Maps	VISSIM	% Processed	Flow Maps	VISSIM	% Processed	Flow Maps	VISSIM	% Processed	Flow Maps	VISSIM	% Processed	Flow Maps	VISSIM	% Processed	
<b>Meetinghouse Lane / State Road / Canal Street</b>																					
Meetinghouse Lane WB	Approach east of intersection	325	316	97.4%	275	267	97.1%	325	316	97.4%	360	354	98.3%	330	322	97.6%	270	264	97.6%		
Meetinghouse Lane EB	East of intersection	255	239	93.8%	440	418	95.0%	340	320	94.1%	275	267	97.0%	525	484	92.2%	440	384	87.4%		
<b>North of Sagamore Bridge - Route 3 Ramps</b>																					
Route 3 SB	Approach before Exit 1A	1510	1460	96.7%	1510	1464	97.0%	1670	1713	102.6%	1680	1630	97.0%	1855	1953	105.3%	1380	1707	123.7%		
Route 3 SB Off-Ramp to Scenic Highway	Exit 1A-B	380	372	97.8%	470	455	96.8%	500	476	95.3%	295	289	98.0%	415	429	103.3%	300	381	127.2%		
Route 3 SB On-Ramp from Scenic Highway		1180	1125	95.3%	895	840	93.8%	1120	1072	95.8%	985	986	100.1%	940	885	94.1%	1585	1200	75.7%		
Route 3 NB Off-Ramp to Meetinghouse Lane	Exit 1A	290	277	95.4%	475	453	95.3%	310	293	94.7%	340	329	96.7%	515	483	93.8%	330	286	86.5%		
Route 3 NB Off-Ramp to Scenic Highway WB	Exit 1B	1015	976	96.2%	1050	1004	95.7%	565	538	95.1%	865	853	98.7%	1305	1237	94.8%	1105	925	83.7%		
Route 3 NB On-Ramp from State Road		435	424	97.4%	395	368	93.2%	325	313	96.2%	375	342	91.2%	425	403	94.8%	300	271	90.4%		
Route 3 NB	After On-Ramp from State Road	1130	1077	95.3%	1570	1480	94.3%	1710	1642	96.0%	1530	1473	96.3%	1955	1813	92.8%	2155	1841	85.4%		
<b>Sagamore Bridge</b>																					
Sagamore Bridge SB		2310	2167	93.8%	1935	1820	94.1%	2290	2256	98.5%	2370	2292	96.7%	2380	2176	91.4%	2665	2396	89.9%		
Sagamore Bridge NB		2000	1938	96.9%	2700	2605	96.5%	2260	2199	97.3%	2360	2347	99.5%	3350	3182	95.0%	3290	2938	89.3%		
<b>South of Sagamore Bridge - Route 6 E Ramps</b>																					
Route 6 E SB Off-Ramp to Mid-Cape Connector	Exit 1C	530	498	93.9%	605	573	94.7%	380	378	99.5%	520	506	97.3%	680	623	91.6%	510	462	90.6%		
Route 6 E SB On-Ramp from Mid-Cape Connector		680	594	87.4%	925	796	86.1%	885	795	89.8%	895	838	93.7%	965	767	79.5%	1115	920	82.5%		
Route 6 E SB	After On-Ramp from Mid-Cape Connector	2460	2207	89.7%	2255	2001	88.7%	2795	2615	93.6%	2745	2573	93.7%	2665	2238	84.0%	3270	2766	84.6%		
Route 6 E NB	Approach before Exit 1C	1840	1818	98.8%	2670	2638	98.8%	1855	1833	98.8%	2345	2313	98.7%	3215	3177	98.8%	2865	2926	102.1%		
Route 6 E NB Off-Ramp to Cranberry Highway	Exit 1C	305	290	95.0%	635	605	95.2%	530	507	95.7%	495	474	95.8%	515	497	96.5%	430	377	87.6%		
Route 6 E NB On-Ramp from Cranberry Highway		465	443	95.4%	665	633	95.2%	935	913	97.6%	510	551	108.1%	650	573	88.1%	855	613	71.7%		
<b>Sandwich Road (Route 6A) / Cranberry Highway</b>																					
Sandwich Road (Route 6A) WB	Approach east of intersection	480	474	98.7%	580	591	101.9%	920	933	101.4%	515	536	104.0%	725	631	87.0%	1210	1141	94.3%		
Sandwich Road (Route 6A) EB	East of intersection	330	405	122.7%	535	539	100.8%	495	451	91.1%	405	413	101.9%	555	556	100.2%	575	529	92.0%		

**Table B-5: VISSIM Processed Volumes Summary and Comparison with Volumes from Flow Maps**

		Processed Volume																	
From	Location/Movement	Fall									Summer								
		Weekday AM			Weekday PM			Saturday MID			Weekday AM			Weekday PM			Saturday MID		
		Flow Maps	VISSIM	% Processed	Flow Maps	VISSIM	% Processed	Flow Maps	VISSIM	% Processed	Flow Maps	VISSIM	% Processed	Flow Maps	VISSIM	% Processed	Flow Maps	VISSIM	% Processed
<b>Buzzards Bay Rotary</b>																			
Main Street (Route 6) EB	Approach west of BB Rotary	675	673	99.8%	580	577	99.6%	880	1025	116.5%	640	689	107.6%	970	964	99.4%	1310	1309	99.9%
Main Street (Route 6) WB	West of BB Rotary	430	412	95.7%	755	748	99.1%	905	744	82.3%	495	461	93.1%	920	843	91.6%	760	647	85.1%
Main Street WB	Approach east of BB Rotary	180	159	88.2%	340	308	90.6%	625	432	69.1%	220	189	86.0%	475	426	89.7%	485	423	87.1%
Buzzards Bay Bypass (Route 6) SWB		285	292	102.5%	520	566	108.8%	365	388	106.3%	295	299	101.3%	485	468	96.6%	315	251	79.5%
Lincoln Avenue SB		65	67	102.7%	65	67	102.7%	105	107	102.0%	70	73	103.6%	80	82	103.0%	120	123	102.6%
<b>Belmont Circle</b>																			
Buzzards Bay Bypass (Route 6) EB		135	183	135.7%	340	372	109.5%	310	351	113.2%	195	194	99.4%	295	302	102.3%	440	358	81.3%
Belmont Circle WB	Thru	240	292	121.7%	550	566	102.8%	405	388	95.8%	305	299	98.0%	500	468	93.7%	255	251	98.3%
Route 25/28 Ramps SB		1185	1136	95.8%	1350	1279	94.7%	1365	1310	96.0%	1165	1127	96.7%	1480	1399	94.6%	1080	973	90.1%
Belmont Circle NB	Thru to the ramps	1915	1813	94.7%	1770	1657	93.6%	1925	1789	93.0%	1795	1734	96.6%	1950	1687	86.5%	1850	1471	79.5%
Main Street (Route 6) WB		1605	1501	93.5%	1630	1496	91.7%	1495	1383	92.5%	1815	1705	93.9%	2195	1903	86.7%	1740	1486	85.4%
Main Street NEB	Thru	700	726	103.7%	895	904	101.0%	665	732	110.0%	1060	1180	111.3%	1095	1062	97.0%	1075	1059	98.5%
Belmont Circle EB	Thru	1290	1294	100.3%	1135	1120	98.7%	1275	1208	94.8%	1115	1183	106.1%	1335	1264	94.7%	1050	904	86.1%
<b>North of Bourne Bridge - Route 25 Ramps</b>																			
Route 25 SB	Approach before Exit 10	1845	1831	99.2%	1755	1721	98.1%	1915	2059	107.5%	1880	1871	99.5%	2370	2592	109.4%	2285	2786	121.9%
Route 25 SB Off-Ramp to Belmont Circle		715	695	97.2%	700	659	94.1%	760	791	104.0%	650	632	97.2%	780	811	104.0%	685	592	86.4%
Route 25 SB On-Ramp from Belmont Circle		760	714	93.9%	700	651	93.0%	1025	832	81.1%	700	673	96.2%	595	512	86.1%	1040	822	79.0%
Route 25 NB Off-Ramp to Belmont Circle		470	445	94.6%	650	630	96.9%	605	526	87.0%	515	501	97.3%	700	597	85.2%	395	392	99.3%
Route 25 NB On-Ramp from Belmont Circle		1155	1090	94.4%	1070	999	93.4%	900	950	105.6%	1095	1055	96.3%	1355	1163	85.8%	810	638	78.7%
Route 25 NB	After On-Ramp from Belmont Circle	1910	1787	93.6%	2230	2054	92.1%	1820	1729	95.0%	1935	1837	94.9%	2645	2224	84.1%	2260	2049	90.7%
<b>Bourne Bridge</b>																			
Bourne Bridge SB		1890	1804	95.4%	1755	1639	93.4%	2180	2048	94.0%	1930	1871	96.9%	2185	2123	97.2%	2640	2353	89.1%
Bourne Bridge NB		1225	1178	96.1%	1810	1755	97.0%	1525	1328	87.1%	1355	1325	97.8%	1990	1689	84.9%	1845	1839	99.6%
<b>South of Bourne Bridge - Bourne Rotary</b>																			
Bourne Bridge SB		1890	1804	95.4%	1755	1639	93.4%	2180	2048	94.0%	1930	1871	96.9%	2185	2123	97.2%	2640	2353	89.1%
Trowbridge Road EB		350	338	96.5%	415	422	101.7%	305	296	97.0%	295	281	95.4%	510	412	80.7%	230	237	103.1%
Trowbridge Road WB	West of Bourne Rotary	285	261	91.6%	215	181	84.2%	455	403	88.5%	145	138	95.3%	235	204	86.6%	265	211	79.5%
Route 28 NB		1435	1410	98.2%	1305	1503	115.2%	1545	1475	95.5%	1325	1310	98.9%	1580	1537	97.3%	1680	1838	109.4%
Route 28 SB	South of Bourne Rotary	1890	1753	92.7%	1335	1198	89.7%	1560	1479	94.8%	1925	1837	95.4%	1610	1464	90.9%	2195	1892	86.2%
Sandwich Road WB		670	633	94.4%	970	776	79.9%	725	783	107.9%	1050	1056	100.6%	845	785	92.9%	1005	825	82.1%
Sandwich Road EB	East of Bourne Rotary	945	897	95.0%	1085	980	90.3%	1215	1084	89.2%	1175	1127	95.9%	1285	1091	84.9%	1250	1116	89.3%
<b>Between Bourne and Sagamore Bridges</b>																			
Scenic Highway EB		1270	1248	98.2%	1060	1027	96.9%	1190	1115	93.7%	1090	1141	104.7%	1215	1123	92.4%	930	788	84.7%
Scenic Highway WB		1550	1450	93.6%	1520	1493	98.2%	1330	1324	99.6%	1405	1637	116.5%	1885	1950	103.4%	1425	1381	96.9%
Sandwich Road EB		940	1031	109.6%	1085	1054	97.1%	1205	1162	96.4%	1170	1198	102.4%	1280	1227	95.9%	1235	1192	96.5%
Sandwich Road WB		775	774	99.9%	1030	1126	109.3%	680	810	119.1%	935	1038	111.0%	1035	1039	100.4%	935	983	105.1%
<b>Scenic Highway (Route 6) / Church Lane</b>																			
Scenic Highway (Route 6) EB	Thru	435	421	96.7%	520	496	95.3%	330	320	96.9%	415	425	102.5%	475	451	94.9%	275	226	82.1%
Scenic Highway (Route 6) EB	Right	865	828	95.7%	630	597	94.7%	745	727	97.6%	680	699	102.8%	630	597	94.8%	805	649	80.7%
Scenic Highway (Route 6) WB	Left	296	302	102.0%	245	250	101.9%	340	350	103.0%	290	293	100.9%	290	290	100.2%	725	601	82.9%
Scenic Highway (Route 6) WB	Thru	1500	1433	95.6%	1485	1414	95.2%	1285	1237	96.3%	1345	1310	97.4%	1860	1780	95.7%	1410	1227	87.0%
<b>Scenic Highway (Route 6) / Route 3 SB Off-Ramp</b>																			
Route 3 SB Off-Ramp SB	Left	115	114	99.1%	160	156	97.5%	120	115	96.0%	75	74	99.0%	60	61	101.5%	65	82	126.1%
Route 3 SB Off-Ramp SB	Right	265	253	95.6%	310	294	94.9%	380	356	93.7%	220	213	96.7%	355	364	102.4%	235	294	125.3%

**Table B-5: VISSIM Processed Volumes Summary and Comparison with Volumes from Flow Maps**

From	Location/Movement	Processed Volume																		
		Fall									Summer									
		Weekday AM			Weekday PM			Saturday MID			Weekday AM			Weekday PM			Saturday MID			
Flow Maps	VISSIM	% Processed	Flow Maps	VISSIM	% Processed	Flow Maps	VISSIM	% Processed	Flow Maps	VISSIM	% Processed	Flow Maps	VISSIM	% Processed	Flow Maps	VISSIM	% Processed	Flow Maps	VISSIM	% Processed
<b>Meetinghouse Lane / State Road / Canal Street</b>																				
Meetinghouse Lane WB	Approach east of intersection	325	316	97.4%	275	267	97.1%	325	316	97.4%	360	354	98.3%	330	322	97.6%	270	264	97.6%	
Meetinghouse Lane EB	East of intersection	255	239	93.8%	440	418	95.0%	340	320	94.1%	275	267	97.0%	525	484	92.2%	440	384	87.4%	
<b>North of Sagamore Bridge - Route 3 Ramps</b>																				
Route 3 SB	Approach before Exit 1A	1510	1460	96.7%	1510	1464	97.0%	1670	1713	102.6%	1680	1630	97.0%	1855	1953	105.3%	1380	1707	123.7%	
Route 3 SB Off-Ramp to Scenic Highway	Exit 1A-B	380	372	97.8%	470	455	96.8%	500	476	95.3%	295	289	98.0%	415	429	103.3%	300	381	127.2%	
Route 3 SB On-Ramp from Scenic Highway		1180	1125	95.3%	895	840	93.8%	1120	1072	95.8%	985	986	100.1%	940	885	94.1%	1585	1200	75.7%	
Route 3 NB Off-Ramp to Meetinghouse Lane	Exit 1A	290	277	95.4%	475	453	95.3%	310	293	94.7%	340	329	96.7%	515	483	93.8%	330	286	86.5%	
Route 3 NB Off-Ramp to Scenic Highway WB	Exit 1B	1015	976	96.2%	1050	1004	95.7%	565	538	95.1%	865	853	98.7%	1305	1237	94.8%	1105	925	83.7%	
Route 3 NB On-Ramp from State Road		435	424	97.4%	395	368	93.2%	325	313	96.2%	375	342	91.2%	425	403	94.8%	300	271	90.4%	
Route 3 NB	After On-Ramp from State Road	1130	1077	95.3%	1570	1480	94.3%	1710	1642	96.0%	1530	1473	96.3%	1955	1813	92.8%	2155	1841	85.4%	
<b>Sagamore Bridge</b>																				
Sagamore Bridge SB		2310	2167	93.8%	1935	1820	94.1%	2290	2256	98.5%	2370	2292	96.7%	2380	2176	91.4%	2665	2396	89.9%	
Sagamore Bridge NB		2000	1938	96.9%	2700	2605	96.5%	2260	2199	97.3%	2360	2347	99.5%	3350	3182	95.0%	3290	2938	89.3%	
<b>South of Sagamore Bridge - Route 6 E Ramps</b>																				
Route 6 E SB Off-Ramp to Mid-Cape Connector	Exit 1C	530	498	93.9%	605	573	94.7%	380	378	99.5%	520	506	97.3%	680	623	91.6%	510	462	90.6%	
Route 6 E SB On-Ramp from Mid-Cape Connector		680	594	87.4%	925	796	86.1%	885	795	89.8%	895	838	93.7%	965	767	79.5%	1115	920	82.5%	
Route 6 E SB	After On-Ramp from Mid-Cape Connector	2460	2207	89.7%	2255	2001	88.7%	2795	2615	93.6%	2745	2573	93.7%	2665	2238	84.0%	3270	2766	84.6%	
Route 6 E NB	Approach before Exit 1C	1840	1818	98.8%	2670	2638	98.8%	1855	1833	98.8%	2345	2313	98.7%	3215	3177	98.8%	2865	2926	102.1%	
Route 6 E NB Off-Ramp to Cranberry Highway	Exit 1C	305	290	95.0%	635	605	95.2%	530	507	95.7%	495	474	95.8%	515	497	96.5%	430	377	87.6%	
Route 6 E NB On-Ramp from Cranberry Highway		465	443	95.4%	665	633	95.2%	935	913	97.6%	510	551	108.1%	650	573	88.1%	855	613	71.7%	
<b>Sandwich Road (Route 6A) / Cranberry Highway</b>																				
Sandwich Road (Route 6A) WB	Approach east of intersection	480	474	98.7%	580	591	101.9%	920	933	101.4%	515	536	104.0%	725	631	87.0%	1210	1141	94.3%	
Sandwich Road (Route 6A) EB	East of intersection	330	405	122.7%	535	539	100.8%	495	451	91.1%	405	413	101.9%	555	556	100.2%	575	529	92.0%	

**Table B-6:** VISSIM Density and LOS Summary

Name	Start Point	End Point	Fall						Summer					
			Weekday AM		Weekday PM		Saturday MID		Weekday AM		Weekday PM		Saturday MID	
			Density	LOS	Density	LOS	Density	LOS	Density	LOS	Density	LOS	Density	LOS
Route 25 SB	Route 25 SB at Plymouth Lane Overpass	On-Ramp merge from Belmont Circle	36	E	68	F	41	E	31	D	149	F	252	F
Route 25 NB	Off-Ramp diverge to Belmont Circle	Route 25 NB at Plymouth Lane Overpass	27	D	66	F	27	D	36	E	35	D	34	D
Belmont Circle Off-Ramp	Off-Ramps merge	Belmont Circle	46	F	52	F	54	F	45	E	60	F	69	F
SB Off-Ramp to Belmont Circle	Route 25 SB	Off-Ramps merge	21	C	26	C	28	C	16	B	52	F	44	E
NB Off-Ramp to Belmont Circle	Route 25 NB	Off-Ramps merge	13	B	24	C	15	B	15	B	18	B	12	B
Belmont Circle On-Ramp	Belmont Circle	On-Ramps diverge	71	F	54	F	64	F	59	F	58	F	89	F
On-Ramp to Route 25 SB	On-Ramps diverge	Route 25 SB	19	B	17	B	22	C	18	B	14	B	60	F
On-Ramp to Route 25 NB	On-Ramps diverge	Route 25 NB	30	D	27	C	26	C	29	D	32	D	17	B
Bourne Bridge SB	On-Ramp merge from Belmont Circle	Bourne Rotary	72	F	62	F	93	F	67	F	125	F	175	F
Bourne Bridge NB	Bourne Rotary	Off-Ramp diverge to Belmont Circle	30	D	61	F	34	D	33	D	43	E	47	F
Route 28 SB	Bourne Rotary	Route 28 SB at Clay Pond Road	42	E	28	D	36	E	34	D	39	E	57	F
Route 28 NB	Route 28 NB at Clay Pond Road	Bourne Rotary	35	D	131	F	74	F	31	D	131	F	67	F
Route 3 SB	Route 3 SB south of Herring Pond Road	On-Ramp merge from Scenic Highway	58	F	38	E	68	F	44	E	152	F	118	F
Route 3 NB	Off-Ramp diverge to Meetinghouse Lane	Route 3 NB south of Herring Pond Road	25	C	34	D	35	D	37	E	48	F	64	F
Route 3 SB Off-Ramp to Scenic Highway	Route 3 SB	Scenic Highway	13	B	13	B	17	B	9	A	16	B	15	B
Scenic Highway On-Ramp to Sagamore Bridge SB	Scenic Highway EB	Sagamore Bridge SB	45	E	31	D	42	E	38	E	44	E	159	F
Route 3 NB Off-Ramp to Scenic Highway EB	Route 3 NB	Scenic Highway EB	8	A	13	B	8	A	9	A	18	C	8	A
Route 3 NB Off-Ramp to Scenic Highway WB	Route 3 NB	Scenic Highway WB	28	C	29	D	15	B	24	C	36	E	77	F
State Road On-Ramp to Route 3 NB	State Road	Route 3 NB	14	B	12	B	10	A	11	B	13	B	9	A
Sagamore Bridge SB	On-Ramp merge from Scenic Highway	Off-Ramp diverge to Mid-Cape Connector	66	F	51	F	69	F	65	F	121	F	134	F
Sagamore Bridge NB	On-Ramp merge from Cranberry Highway	Off-Ramp diverge to Meetinghouse Lane	54	F	83	F	62	F	73	F	104	F	151	F
Route 6 E SB	Off-Ramp diverge to Mid-Cape Connector	Route 6 E SB north of Route 130	50	F	45	F	61	F	51	F	84	F	105	F
Route 6 E NB	Route 6 E NB north of Route 130	On-Ramp merge from Cranberry Highway	48	F	79	F	48	F	67	F	98	F	149	F
Route 6 E SB Off-Ramp to Mid-Cape Connector	Route 6 E SB	Mid-Cape Connector	17	B	20	B	13	B	17	B	22	C	16	B
Mid-Cape Connector On-Ramp to Route 6 E SB	Mid-Cape Connector	Route 6 E SB	16	B	25	C	23	C	22	C	22	C	36	E
Route 6 E NB Off-Ramp to Cranberry Highway	Route 6 E NB	Cranberry Highway	12	B	26	C	21	C	20	B	20	B	15	B
Cranberry Highway On-Ramp to Route 6 E NB	Cranberry Highway	Route 6 E NB	11	B	18	B	26	C	14	B	22	C	109	F



## Appendix C

### Model Calibrations

HCS

Table C-1: HCS CAF and SAF Calibration Summary - Fall

			Fall AM						Fall PM						Fall SAT					
			Freeway Capacity Adjustment Factor			Speed Adjustment Factor			Freeway Capacity Adjustment Factor			Speed Adjustment Factor			Freeway Capacity Adjustment Factor			Speed Adjustment Factor		
			Default	New	Notes	Default	New	Notes	Default	New	Notes	Default	New	Notes	Default	New	Notes	Default	New	Notes
Bourne Bridge	North of Bourne Bridge	Route 25 SB	0.939	No change		0.95	0.29		0.939	No change	At 0.39, LOS goes from B to F.	0.95	0.29		0.939	No change		0.95	0.29	
		Route 25 NB	0.939	No change		0.95	No change		0.939	No change		0.95	No change		0.939	No change		0.95	No change	
	Bourne Bridge	Bridge SB	0.939	No change		0.95	0.71		0.939	No change		0.95	0.81		0.939	-		0.95	-	
		Bridge NB	0.939	No change		0.95	No change		0.939	No change		0.95	0.75		0.939	-		0.95	-	
	North of Bourne Bridge	Route 25 SB Diverge	0.939	No change		0.95	No change		0.939	No change	At 0.25, LOS goes from B to F.	0.95	No change		0.939	-		0.95	-	
		Route 25 SB Merge	0.939	0.47	At 0.46, LOS goes from C to F.	0.95	0.29		0.939	0.53	At 0.54, it was still LOS C.	0.95	No change		0.939	0.64	At 0.65, it was still LOS C.	0.95	No change	
		Route 25 NB Diverge	0.939	-		0.95	-		0.939	-		0.95	-		0.939	-		0.95	-	
		Route 25 NB Merge	0.939	-		0.95	-		0.939	-		0.95	-		0.939	-		0.95	-	
Sagamore Bridge	North of Sagamore Bridge	Route 3 SB	0.939	0.7	At 0.41, LOS goes from B to F.	0.95	0.5	Congestion due to speed reduction downstream on bridge.	0.939	0.7	At 0.48, LOS jumps from C to F.	0.95	0.38	Congestion due to speed reduction downstream on bridge.	0.939	0.6		0.95	0.3	Congestion due to speed reduction downstream on bridge.
		Route 3 NB	0.939	No change		0.95	No change		0.939	No change		0.95	-		0.939	No change		0.95	No change	
	Sagamore Bridge	Bridge SB	0.939	-		0.95	-		0.939	0.71		0.95	-		0.939	0.79		0.95	No change	
		Bridge NB	0.939	-		0.95	-		0.939	No change		0.95	-		0.939	No change		0.95	No change	
	South of Sagamore	Route 6 SB	0.939	-		0.95	-		0.939	-		0.95	-		0.939	-		0.95	-	
		Route 6 NB	0.939	-		0.95	-		0.939	0.89		0.95	-		0.939	-		0.95	-	
	North of Sagamore Bridge	Route 3 SB Diverge	0.939	No change		0.95	No change	Changing SAF doesn't affect.	0.939	0.35	At 0.36, it was still LOS B	0.95	-	Changing SAF doesn't affect.	0.939	-		0.95	-	
		Route 3 NB Diverge to Scenic Highway EB	0.939	-		0.95	-		0.939	-		0.95	-		0.939	-		0.95	-	
		Route 3 NB Diverge to Scenic Highway WB	0.939	-		0.95	-		0.939	-		0.95	-		0.939	-		0.95	-	
		Route 3 NB Merge	0.939	-		0.95	-		0.939	-		0.95	-		0.939	-		0.95	-	
	South of Sagamore Bridge	Route 6 SB Diverge	0.939	-		0.95	-		0.939	-		0.95	-		0.939	-		0.95	-	
Route 6 SB Merge		0.939	-		0.95	-		0.939	-		0.95	-		0.939	-		0.95	-		
Route 6 NB Diverge		0.939	-		0.95	-		0.939	-		0.95	-		0.939	-		0.95	-		
		Route 6 NB Merge	0.939	-		0.95	-		0.939	0.82	At 0.83, it was still LOS D	0.95	-		0.939	0.82	At 0.81, LOS goes from D to F.	0.95	No change	

Table C-2: HCS CAF and SAF Calibration Summary - Summer

			Summer AM						Summer PM						Summer SAT					
			Freeway Capacity Adjustment Factor			Speed Adjustment Factor			Freeway Capacity Adjustment Factor			Speed Adjustment Factor			Freeway Capacity Adjustment Factor			Speed Adjustment Factor		
			Default	New	Notes	Default	New	Notes	Default	New	Notes	Default	New	Notes	Default	New	Notes	Default	New	Notes
Bourne Bridge	North of Bourne Bridge	Route 25 SB	0.939	No change	At 0.31, LOS jumps from B to F.	0.95	0.5	Congestion due to speed reduction downstream on bridge	0.939	No change	At 0.39, LOS goes from B to F.	0.95	0.29		0.939	No change		0.95	0.29	
		Route 25 NB	0.939	No change		0.95	No change		0.939	No change		0.95	No change		0.939	No change		0.95	No change	
	Bourne Bridge	Bridge SB	0.939	0.62	At 0.61, LOS jumps from D to F.	0.95	0.74	At 0.73, LOS jumps from E to F.	0.939	No change		0.95	0.81		0.939	-		0.95	-	
		Bridge NB	0.939	No change		0.95	No change		0.939	No change		0.95	0.75		0.939	-		0.95	-	
	North of Bourne Bridge	Route 25 SB Diverge	0.939	No change	At 0.19, LOS jumps from B to F.	0.95	No change	Has no effect	0.939	No change	At 0.25, LOS goes from B to F.	0.95	No change		0.939	-		0.95	-	
		Route 25 SB Merge	0.939	No change	At 0.47, LOS jumps from C to F	0.95	No change	Has no effect	0.939	0.53	At 0.54, it was still LOS C.	0.95	No change		0.939	0.64	At 0.65, it was still LOS C.	0.95	No change	
		Route 25 NB Diverge	0.939	-		0.95	-		0.939	-		0.95	-		0.939	-		0.95	-	
		Route 25 NB Merge	0.939	-		0.95	-		0.939	-		0.95	-		0.939	-		0.95	-	
Sagamore Bridge	North of Sagamore Bridge	Route 3 SB	0.939	0.70	At 0.44, LOS jumps from B to F.	0.95	0.5	Congestion due to speed reduction downstream on bridge	0.939	0.7	At 0.48, LOS jumps from C to F.	0.95	0.38	Congestion due to speed reduction downstream on bridge.	0.939	0.6		0.95	0.3	Congestion due to speed reduction downstream on bridge.
		Route 3 NB	0.939	No change		0.95	No change		0.939	No change		0.95	-		0.939	No change		0.95	No change	
	Sagamore Bridge	Bridge SB	0.939	-		0.95	-		0.939	0.71		0.95	-		0.939	0.79		0.95	No change	
		Bridge NB	0.939	-		0.95	-		0.939	No change		0.95	-		0.939	No change		0.95	No change	
	South of Sagamore	Route 6 SB	0.939	-		0.95	-		0.939	-		0.95	-		0.939	-		0.95	-	
		Route 6 NB	0.939	-		0.95	-		0.939	0.89		0.95	-		0.939	-		0.95	-	
	North of Sagamore Bridge	Route 3 SB Diverge	0.939	0.35	At 0.34, LOS jumps from B to F	0.95	No change	Changing SAF doesn't change much	0.939	0.35	At 0.36, it was still LOS B	0.95	-	Changing SAF doesn't affect.	0.939	-		0.95	-	
		Route 3 NB Diverge to Scenic Highway EB	0.939	-		0.95	-		0.939	-		0.95	-		0.939	-		0.95	-	
		Route 3 NB Diverge to Scenic Highway WB	0.939	-		0.95	-		0.939	-		0.95	-		0.939	-		0.95	-	
		Route 3 NB Merge	0.939	-		0.95	-		0.939	-		0.95	-		0.939	-		0.95	-	
	South of Sagamore Bridge	Route 6 SB Diverge	0.939	-		0.95	-		0.939	-		0.95	-		0.939	-		0.95	-	
		Route 6 SB Merge	0.939	-		0.95	-		0.939	-		0.95	-		0.939	-		0.95	-	
		Route 6 NB Diverge	0.939	-		0.95	-		0.939	-		0.95	-		0.939	-		0.95	-	
Route 6 NB Merge		0.939	-		0.95	-		0.939	0.82	At 0.83, it was still LOS D	0.95	-		0.939	0.82	At 0.81, LOS goes from D to F.	0.95	No change		

VISSIM

**Table C-3: VISSIM Calibration Summary**

<b>Setting</b>	<b>No.</b>	<b>Name</b>	<b>Link 1</b>	<b>Link 2</b>	<b>Type</b>	<b>Original</b>	<b>Modified</b>
Conflict Area	-	-	10002: Route 6A EB	10189: Sandwich Road WB/SB	Critical Gap	3.5	2
Conflict Area	-	-	10002: Route 6A EB	10189: Sandwich Road WB/SB	Rear Gap	0.5	0.1
Conflict Area	-	-	10002: Route 6A EB	10189: Sandwich Road WB/SB	Front Gap	0.5	0.1
					Safe Distance		
Conflict Area	-	-	10002: Route 6A EB	10189: Sandwich Road WB/SB	Factor	1.5	1
Conflict Area	-	-	10008: Route 6A WB	10189: Sandwich Road WB/SB	Critical Gap	3.5	2
Conflict Area	-	-	10008: Route 6A WB	10189: Sandwich Road WB/SB	Rear Gap	0.5	0.1
Conflict Area	-	-	10008: Route 6A WB	10189: Sandwich Road WB/SB	Front Gap	0.5	0.1
					Safe Distance		
Conflict Area	-	-	10008: Route 6A WB	10189: Sandwich Road WB/SB	Factor	1.5	1
Conflict Area	-	-	10073: Buzzards Bay Bypass (Route 6) WB/SWB	10075: Head of the Bay Road SB	Critical Gap	3.5	2
Conflict Area	-	-	10073: Buzzards Bay Bypass (Route 6) WB/SWB	10075: Head of the Bay Road SB	Rear Gap	0.5	0.2
Conflict Area	-	-	10073: Buzzards Bay Bypass (Route 6) WB/SWB	10075: Head of the Bay Road SB	Front Gap	0.5	0.2
Conflict Area	-	-	10073: Buzzards Bay Bypass (Route 6) WB/SWB	10258: Bourne Rotary N SB	Critical Gap	3.5	2
Conflict Area	-	-	10073: Buzzards Bay Bypass (Route 6) WB/SWB	10258: Bourne Rotary N SB	Rear Gap	0.5	0.2
Conflict Area	-	-	10073: Buzzards Bay Bypass (Route 6) WB/SWB	10258: Bourne Rotary N SB	Front Gap	0.5	0.2
Conflict Area	-	-	10075: Head of the Bay Road SB	10258: Bourne Rotary N SB	Critical Gap	3.5	2
Conflict Area	-	-	10075: Head of the Bay Road SB	10258: Bourne Rotary N SB	Rear Gap	0.5	0.1
Conflict Area	-	-	10075: Head of the Bay Road SB	10258: Bourne Rotary N SB	Front Gap	0.5	0.1
					Safe Distance		
Conflict Area	-	-	10075: Head of the Bay Road SB	10258: Bourne Rotary N SB	Factor	1.5	1
Conflict Area	-	-	10083: Bourne Rotary N NB	10119: Bourne Rotary N NB	Critical Gap	3.5	2
Conflict Area	-	-	10083: Bourne Rotary N NB	10119: Bourne Rotary N NB	Rear Gap	0.5	0.1
Conflict Area	-	-	10083: Bourne Rotary N NB	10119: Bourne Rotary N NB	Front Gap	0.5	0.1
					Safe Distance		
Conflict Area	-	-	10083: Bourne Rotary N NB	10119: Bourne Rotary N NB	Factor	1.5	1
Conflict Area	-	-	10086: Route 25/28 Off-Ramps SB	10261: Route 25/28 Off-Ramps SB	Critical Gap	3.5	2
Conflict Area	-	-	10086: Route 25/28 Off-Ramps SB	10261: Route 25/28 Off-Ramps SB	Rear Gap	0.5	0.1
Conflict Area	-	-	10086: Route 25/28 Off-Ramps SB	10261: Route 25/28 Off-Ramps SB	Front Gap	0.5	0.1
					Safe Distance		
Conflict Area	-	-	10086: Route 25/28 Off-Ramps SB	10261: Route 25/28 Off-Ramps SB	Factor	1.5	1
Conflict Area	-	-	10122: Bourne Rotary N SB	10258: Bourne Rotary N SB	Critical Gap	3.5	2
Conflict Area	-	-	10122: Bourne Rotary N SB	10258: Bourne Rotary N SB	Rear Gap	0.5	0.1
Conflict Area	-	-	10122: Bourne Rotary N SB	10258: Bourne Rotary N SB	Front Gap	0.5	0.1
Conflict Area	-	-	10128: Bourne Rotary S	10254: Bourne Rotary S SB	Critical Gap	3.5	2
Conflict Area	-	-	10128: Bourne Rotary S	10254: Bourne Rotary S SB	Rear Gap	0.5	0.1
Conflict Area	-	-	10128: Bourne Rotary S	10254: Bourne Rotary S SB	Front Gap	0.5	0.1
Conflict Area	-	-	10128: Bourne Rotary S	10254: Bourne Rotary S SB	Front Gap	1.5	1

**Table C-3: VISSIM Calibration Summary**

<b>Setting</b>	<b>No.</b>	<b>Name</b>	<b>Link 1</b>	<b>Link 2</b>	<b>Type</b>	<b>Original</b>	<b>Modified</b>
Conflict Area	-	-	10129: Route 28 NB	10249: Bourne Rotary S EB	Critical Gap	3.5	2
Conflict Area	-	-	10129: Route 28 NB	10249: Bourne Rotary S EB	Rear Gap	0.5	0.1
Conflict Area	-	-	10129: Route 28 NB	10249: Bourne Rotary S EB	Front Gap	0.5	0.1
					Safe Distance		
Conflict Area	-	-	10129: Route 28 NB	10249: Bourne Rotary S EB	Factor	1.5	1
Conflict Area	-	-	10131: Bourne Rotary S WB	10132: Bourne Rotary S WB	Critical Gap	3.5	2
Conflict Area	-	-	10131: Bourne Rotary S WB	10132: Bourne Rotary S WB	Rear Gap	0.5	0.2
Conflict Area	-	-	10131: Bourne Rotary S WB	10132: Bourne Rotary S WB	Front Gap	0.5	0.2
Conflict Area	-	-	10133: Sandwich Road WB/SB	10271: Sandwich Road WB/SB	Critical Gap	3.5	2
Conflict Area	-	-	10133: Sandwich Road WB/SB	10271: Sandwich Road WB/SB	Rear Gap	0.5	0.2
Conflict Area	-	-	10133: Sandwich Road WB/SB	10271: Sandwich Road WB/SB	Front Gap	0.5	0.2
					Safe Distance		
Conflict Area	-	-	10133: Sandwich Road WB/SB	10271: Sandwich Road WB/SB	Factor	1.5	1
Conflict Area	-	-	10134: Sandwich Road EB/NB	10271: Sandwich Road WB/SB	Critical Gap	3.5	2
Conflict Area	-	-	10134: Sandwich Road EB/NB	10271: Sandwich Road WB/SB	Rear Gap	0.5	0.2
Conflict Area	-	-	10134: Sandwich Road EB/NB	10271: Sandwich Road WB/SB	Front Gap	0.5	0.2
					Safe Distance		
Conflict Area	-	-	10134: Sandwich Road EB/NB	10271: Sandwich Road WB/SB	Factor	1.5	1
Conflict Area	-	-	10134: Sandwich Road EB/NB	10270: Sandwich Road EB/NB	Critical Gap	3.5	2
Conflict Area	-	-	10134: Sandwich Road EB/NB	10270: Sandwich Road EB/NB	Rear Gap	0.5	0.2
Conflict Area	-	-	10134: Sandwich Road EB/NB	10270: Sandwich Road EB/NB	Front Gap	0.5	0.2
Conflict Area	-	-	10183: Cranberry Highway WB/SB	10189: Sandwich Road WB/SB	Critical Gap	3.5	2.5
Conflict Area	-	-	10186: Regency Drive NB	10189: Sandwich Road WB/SB	Critical Gap	3.5	2
Conflict Area	-	-	10253: Bourne Rotary S SB	10255: Bourne Rotary S WB	Critical Gap	3.5	2
Conflict Area	-	-	10253: Bourne Rotary S SB	10255: Bourne Rotary S WB	Rear Gap	0.5	0.1
Conflict Area	-	-	10253: Bourne Rotary S SB	10255: Bourne Rotary S WB	Front Gap	0.5	0.1
					Safe Distance		
Conflict Area	-	-	10253: Bourne Rotary S SB	10255: Bourne Rotary S WB	Factor	1.5	1
Conflict Area	-	-	10310: Scenic Highway (Route 6) WB	10311: Side Street - 7	Critical Gap	3.5	2
Conflict Area	-	-	10310: Scenic Highway (Route 6) WB	10311: Side Street - 7	Rear Gap	0.5	0.2
Conflict Area	-	-	10310: Scenic Highway (Route 6) WB	10311: Side Street - 7	Front Gap	0.5	0.2
Conflict Area	-	-	10321: Sandwich Road WB/SB	10322: Side Street - 10	Critical Gap	3.5	2
Conflict Area	-	-	10321: Sandwich Road WB/SB	10322: Side Street - 10	Rear Gap	0.5	0.1
Conflict Area	-	-	10321: Sandwich Road WB/SB	10322: Side Street - 10	Front Gap	0.5	0.1
					Safe Distance		
Conflict Area	-	-	10321: Sandwich Road WB/SB	10322: Side Street - 10	Factor	1.5	1
Connector	10037	Route 6 NB	-	-	Desired Direction	All	Left
Connector	10016	Scenic Highway (Route 6) WB	-	-	Lane Change	656.2	1000
Connector	10023	Route 3 SB	-	-	Lane Change	656.2	2000
Connector	10024	Route 3 SB	-	-	Lane Change	656.2	2000
Connector	10025	Route 3 SB	-	-	Lane Change	656.2	2000
Connector	10026	Route 3 NB	-	-	Lane Change	656.2	2000
Connector	10027	Route 3 NB	-	-	Lane Change	656.2	2000
Connector	10028	Route 6 SB	-	-	Lane Change	656.2	2000

**Table C-3: VISSIM Calibration Summary**

<b>Setting</b>	<b>No.</b>	<b>Name</b>	<b>Link 1</b>	<b>Link 2</b>	<b>Type</b>	<b>Original</b>	<b>Modified</b>
Connector	10029	Route 6 SB	-	-	Lane Change	656.2	2000
Connector	10030	Route 6 SB	-	-	Lane Change	656.2	2000
Connector	10031	Route 6 SB	-	-	Lane Change	656.2	2000
Connector	10032	Route 6 SB	-	-	Lane Change	656.2	2000
Connector	10033	Route 3 NB	-	-	Lane Change	656.2	2000
Connector	10034	Route 6 NB	-	-	Lane Change	656.2	2000
Connector	10035	Route 6 NB	-	-	Lane Change	656.2	2000
Connector	10036	Route 6 NB	-	-	Lane Change	656.2	2000
Connector	10037	Route 6 NB	-	-	Lane Change	656.2	2000
Connector	10038	Route 6 NB	-	-	Lane Change	656.2	2000
Connector	10039	Route 25 SB	-	-	Lane Change	656.2	2000
Connector	10040	Route 25 SB	-	-	Lane Change	656.2	2000
Connector	10041	Route 25 SB	-	-	Lane Change	656.2	2000
Connector	10042	Route 25 NB	-	-	Lane Change	656.2	2000
Connector	10043	Route 25 NB	-	-	Lane Change	656.2	2000
Connector	10044	Route 28 SB	-	-	Lane Change	656.2	2000
Connector	10045	Route 28 SB	-	-	Lane Change	656.2	2000
Connector	10046	Route 28 NB	-	-	Lane Change	656.2	2000
Connector	10047	Route 28 NB	-	-	Lane Change	656.2	2000
Connector	10048	Route 28 NB	-	-	Lane Change	656.2	2000
Connector	10069	Bourne Rotary N EB	-	-	Lane Change	656.2	2000
Connector	10071	Bourne Rotary N WB	-	-	Lane Change	656.2	2000
Connector	10073	Buzzards Bay Bypass (Route 6) WB/SWB	-	-	Lane Change	656.2	1000
Connector	10077	Main Street WB	-	-	Lane Change	656.2	1000
Connector	10081	Route 25/28 On-Ramps NB	-	-	Lane Change	656.2	2000
Connector	10084	Route 25 Off-Ramp SB	-	-	Lane Change	656.2	2000
Connector	10085	Route 25 On-Ramp NB	-	-	Lane Change	656.2	2000
Connector	10087	Route 28 SB Off-Ramp	-	-	Lane Change	656.2	2000
Connector	10089	Route 28 SB On-Ramp	-	-	Lane Change	656.2	2000
Connector	10122	Bourne Rotary N SB	-	-	Lane Change	656.2	1000
Connector	10130	Bourne Rotary Connector NB	-	-	Lane Change	656.2	200
Connector	10160	Route 6 SB Off-Ramp Exit 1C Route 6 SB On-Ramp from Mid-Cape	-	-	Lane Change	656.2	2000
Connector	10161	Connector	-	-	Lane Change	656.2	2000
Connector	10173	Route 6 NB Off-Ramp Exit 1C	-	-	Lane Change	656.2	2000
Connector	10176	Cranberry Highway WB/SB	-	-	Lane Change	656.2	1000
Connector	10179	Cranberry Highway EB/NB	-	-	Lane Change	656.2	2000
Connector	10180	Cranberry Highway EB/NB	-	-	Lane Change	656.2	2000
Connector	10205	Route 6 SB On-Ramp from Scenic Highway	-	-	Lane Change	656.2	2000
Connector	10206	Route 6 SB On-Ramp from Scenic Highway	-	-	Lane Change	656.2	2000
Connector	10207	Route 6 SB On-Ramp from Scenic Highway	-	-	Lane Change	656.2	1000



**Table C-3: VISSIM Calibration Summary**

<b>Setting</b>	<b>No.</b>	<b>Name</b>	<b>Link 1</b>	<b>Link 2</b>	<b>Type</b>	<b>Original</b>	<b>Modified</b>
Connector	10213	Route 3 SB Off-Ramp Exit 1A	-	-	Lane Change	656.2	2000
Connector	10217	Route 6 NB Off-Ramp Exit 1B	-	-	Lane Change	656.2	2500
Connector	10243	Route 6 NB	-	-	Lane Change	656.2	2000
		Route 6 NB On-Ramp from Cranberry					
Connector	10244	Highway	-	-	Lane Change	656.2	2000
Connector	10245	Route 6 NB Off-Ramp Exit 1A	-	-	Lane Change	656.2	2000
Connector	10248	Route 28 SB	-	-	Lane Change	656.2	1000
Connector	10249	Bourne Rotary S EB	-	-	Lane Change	656.2	800
Connector	10250	Bourne Rotary S EB	-	-	Lane Change	656.2	1000
Connector	10257	Bourne Rotary S NB	-	-	Lane Change	656.2	200
					Look Ahead		
Link	43	Route 6 NB	-	-	Distance	1640	2500
					Look Ahead		
Link	45	Route 6 NB	-	-	Distance	1640	2500
					No Lane Change		
Link	170	Route 28 NB	-	-	Right		Check
					No Lane Change		
Link	53	Route 28 SB	-	-	Right		Check
Driving Behavior	1	Urban (motorized)	-	-	Consider next turn		Check
					Cooperative lane		
Driving Behavior	1	Urban (motorized)	-	-	change		Check
Driving Behavior	3	Freeway (free lane selection)	-	-	Consider next turn		Check
					Cooperative lane		
Driving Behavior	3	Freeway (free lane selection)	-	-	change		Check

## 5.2 Summary of Future No Build Modeling Process and Results (Draft)

**Date**  
12/17/2021

**To**  
Amy Getchell, MassDOT



**PROJECT  
CORRESPONDENCE**

**From**  
Alexandra Siu, P.E., PTOE  
Paul Nelson

**Subject**  
Cape Cod Canal Bridges Program –  
Summary of Future No Build  
Modeling Process and Results

**Overview:**

Use of the “Sensitivity Case” Future No Build scenario is recommended based on our evaluation of relevant travel trends and how they impact traffic volumes within the Cape Cod Canal study area. While travel patterns are similar for both 2045 Future No Build scenarios tested, the Sensitivity Case reflects higher overall traffic volumes and provides a more conservative baseline for the comparison of alternatives. The Sensitivity Case Future No Build scenario has the added benefit of capturing travel pattern changes due to several emerging trends, including:

- Migrations of non-retired families to their vacation homes on Cape Cod during the COVID-19 pandemic may have been a one-time phenomenon as many have reportedly returned to their primary residence once in-person schooling resumed.
- New housing construction on Cape Cod is expected to continue to cater to higher income retirees and people seeking vacation homes (based on trends identified from IRS data), and this will continue the trend of lower-wage workers seeking housing outside of Cape Cod.
- Some conversion of homes from seasonal use to year-round households is expected, but no information indicated it would be higher than the 11,000 homes (~10% of total existing supply) indicated in the stated preference survey conducted by the Cape Cod Commission.
- Total employment levels are expected to stay at 2020 levels through 2045 due to counteracting trends affecting future employment levels.
  - The first trend is the decrease in employment driven by the overall decrease in population (in jobs like education, government services, and grocery stores).
  - The second trend is the growth in jobs related to Cape Cod’s aging population (healthcare, administrative and support services) and popularity as a vacation destination (food services and drinking places, construction of buildings, etc.).

The Barnstable County socio-economic forecast under the “Sensitivity Case” Future No Build scenario is summarized in Table 1. The resulting change in traffic volumes during peak hour conditions for Summer Weekday PM and Summer Weekend Saturday for the Cape Cod Canal bridges is shown in Table 2 and the change in volumes on the Canalside Roadways (Scenic Highway and Sandwich Road) is shown in Table 3.

**Table 1: Barnstable County Socio-Economic Forecasts - Comparison of 2019 Existing Conditions to the Future No Build “Sensitivity Case” Scenario**

Model Condition	Population	Households	Employment
2019 Existing Conditions	212,990	94,323	97,672
2045 Sensitivity Case (FXM)	192,559	90,323	96,878
<i>Diff. from Existing</i>	-9.6%	-4.2%	-0.8%

**Table 2: Bridge Traffic Volumes - Comparison of 2019 Existing Conditions to the Future No Build “Sensitivity Case” Scenario**

Model Condition	Bourne Bridge		Sagamore Bridge		Total Crossings
	North	South	North	South	
<b>Summer Weekday PM</b>					
2019 Existing Conditions	1,990	2,185	3,350	2,380	<b>9,905</b>
2045 Sensitivity Case (FXM)	2,915	2,285	3,955	2,605	<b>11,760</b>
<i>Diff. from Existing</i>	46.5%	4.6%	18.1%	9.5%	<b>18.7%</b>
<b>Summer Weekend Saturday</b>					
2019 Existing Conditions	1,845	2,640	3,290	2,665	<b>10,440</b>
2045 Sensitivity Case (FXM)	2,295	2,710	3,880	3,470	<b>12,355</b>
<i>Diff. from Existing</i>	24.4%	2.7%	17.9%	30.2%	<b>18.3%</b>

**Table 3: Canal Roadway Traffic Volumes - Comparison of 2019 Existing Conditions to the Future No Build “Sensitivity Case” Scenario**

Model Condition	Scenic Highway		Sandwich Rd		Total Canalside
	East	West	East	West	
<b>Summer Weekday PM</b>					
2019 Existing Conditions	1,215	2,125	1,350	1,035	<b>5,725</b>
2045 Sensitivity Case (FXM)	1,840	2,375	1,300	1,685	<b>7,200</b>
<i>Diff. from Existing</i>	51.4%	11.8%	-3.7%	62.8%	<b>25.8%</b>
<b>Summer Weekend Saturday</b>					
2019 Existing Conditions	930	1,590	1,410	935	<b>4,865</b>
2045 Sensitivity Case (FXM)	1,495	1,910	1,305	1,145	<b>5,855</b>
<i>Diff. from Existing</i>	60.8%	20.1%	-7.4%	22.5%	<b>20.3%</b>

## Summary of Future No Build Scenario Development:

As outlined in the “Future Demographic Conditions” memo dated May 14, 2021, two scenarios were developed for the Future No Build conditions within the study area for the Cape Cod Bridges Program, a “Base Case” scenario and a “Sensitivity Case” scenario. The two Future No Build conditions scenarios were investigated to ensure that the measures of effectiveness for the project’s alternatives development capture the range of anticipated possible future projections.

Establishing the Base Case scenario followed a similar method as the initial planning study, with changes in visitor and non-visitor trips estimated separately. In a memorandum prepared by FXM Associates, dated August 4, 2021 an annual growth rate of 0.70% was established for visitor tips based on evaluation of historic growth in Cape Cod Canal bridge volumes and employment trends in jobs classified as Accommodations and Food Services (NAICS 72). Applying this growth rate to the 2019 visitor trips leads to the following changes in visitor volumes during the time periods evaluated:

- Summer Weekday PM peak hour visitor trips increase from 3,905 to 4,695 (20% increase)
- Summer Weekend Saturday peak hour visitor trips increase from 6,115 to 7,425 (21% increase)

The 2040 population, households, and employment levels identified by the UMass Donahue Institute (UMDI) and approved MassDOT OTP were used as the basis for estimating the changes in non-visitor trips by 2045. The total population, households, and employment levels for Barnstable County are shown in Table 4. This future data indicates a decrease in all three categories. The demographic data was not extrapolated from 2040 to 2045 because continuation of the trends between the 2030 and 2040 will result in unrealistically low estimates of trips.

**Table 4: Barnstable County Socio-Economic Forecasts - Comparison of 2019 Existing Conditions to the Future No Build “Base Case” Scenario**

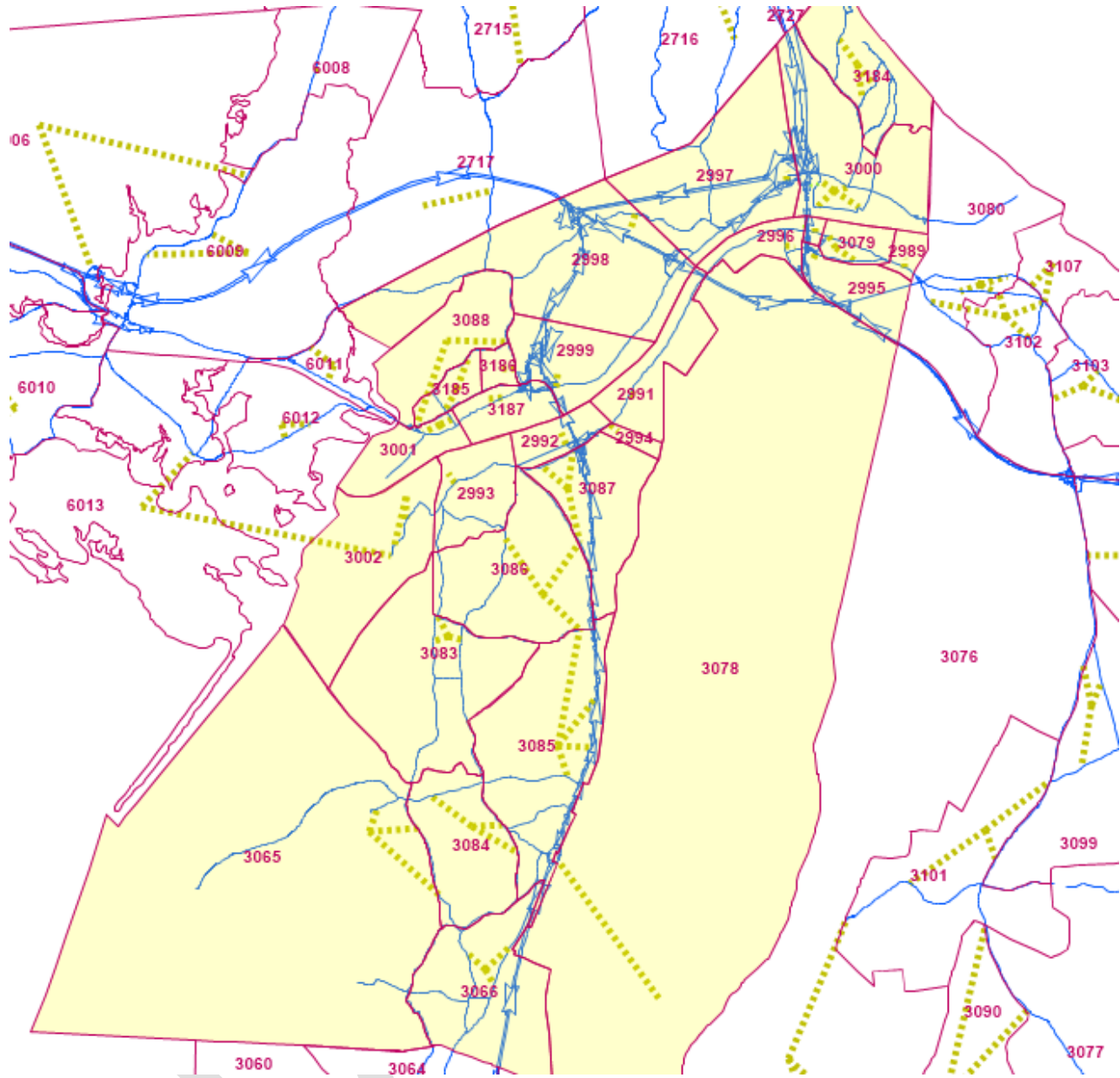
Model Condition	Population	Households	Employment
2019 Existing Conditions	212,990	94,323	97,672
2045 Base Case (UMDI)	176,007	82,313	75,299
<i>Diff. from Existing</i>	-17.4%	-12.7%	-22.9%

Adjustments were required to the allocation of population, households, and employment in the Town of Bourne to ensure accurate estimation of vehicle trips in the Future No Build scenarios. As the first adjustment, the 2019 existing population, household, and employment totals for each traffic analysis zone (TAZ) in the Town of Bourne were re-allocated based on data obtained from US Bureau of Census’ American Community Survey (ACS). This adjustment was required because the overall distribution of population, households, and employment between TAZs did not match actual levels of development and having an inaccurate breakdown in the 2019 existing conditions travel demand model was leading to skewed growth rates in the Future No Build scenarios.

As another adjustment, twelve new TAZs were created in the Town of Bourne and one new TAZ was created in the Town of Sandwich in both the 2019 Existing Conditions and Future No Build Conditions, all in the vicinity of the canal bridges and approach roadways to improve the overall accuracy of the travel demand model. Each new TAZ was created by splitting an existing TAZ into smaller zones and allocating a specified percentage of the original zone’s population, households, and employment. Table 5 provides information on how demographic information was allocated to each new TAZ and Figure 1 shows the final configuration of TAZs used in the travel demand model.

**Table 5: Overview of additional TAZs created in the Towns of Bourne and Sandwich**

Original TAZ	New TAZ	Percent	Original TAZ	New TAZ	Percent
2999 - Bournedale Road	2998 (new) 2999	25% 75%	3079 – Sagamore Bridge South	2989 (new)	10%
				2990 (new)	10%
				2995 (new)	30%
				2996 (new)	20%
				3079	30%
3000 – Sagamore Flyover	2997 (new) 3000	15% 85%	3087 – East of Bourne Rotary	2991 (new)	10%
				2992 (new)	10%
				2993 (new)	20%
				3087	60%
3001 – Buzzards Bay	3001 3187 (new)	50% 50%	3185 – North of Belmont Circle	3185	60%
				3186 (new)	40%
3078 – Joint Base CC	2994 (new) 3078	30% 70%	3099 – East of Joint Base CC (Town of Sandwich)	2988 (new)	60%
				3099	40%



**Figure 1: Map of new TAZ structure in the Town of Bourne**

Final adjustments to population, households, and employment for TAZs in the Town of Bourne and some in the Town of Plymouth for the Future No Build conditions were made to reflect the following planned and/or permitted projects:

Town of Bourne

- Canalside Commons
- Cape View Way
- Canal Street Crossing
- Buzzards Bay Growth Incentive Zone (GIZ)

Town of Plymouth

- Residences at Elbow Pond Road
- Redbrook
- Sandy Pines

Projects in the town of Bourne are expected to add a total of 1,057 new households, 2,600 new population, and 328 new jobs by 2045 while projects in the Town of Plymouth are expected to add a total of 872 new households, 240 new population, and 90 new jobs by 2045. The growth expected in the Town of Bourne due to these planned and/or permitted projects is at odds with the estimated decreases in population, households, and employment in the UMDI projections. This meant that the growth could not be reallocated to the affected TAZs while keeping the same overall community total without resulting in TAZs that lose an unrealistic amount of people, households, and/or employment. As a result, population and households were transferred from TAZs in the Town of Mashpee as outlined in Table 6 and employment was transferred as outlined in Table 7. The Town of Mashpee, as a community in Barnstable County with identified growth, was selected for the transfer due to its proximity to the Town of Bourne and less favorable access conditions. The combined overall total for both communities in all three demographic categories was maintained.

**Table 6: Reallocation of Population and Households from select TAZs in Mashpee to Bourne**

Model Condition	Mashpee Population			Mashpee Households		
	3070	3075	3077	3070	3075	3077
2019 Existing Conditions	1965	2120	3357	892	964	1411
2045 Unadjusted Conditions	2196	2833	3758	1083	1445	1786
2045 Adjusted Conditions	1749	1455	2983	890	960	1407
<i>Allocation to Bourne TAZs</i>	<i>-447</i>	<i>-1378</i>	<i>-775</i>	<i>-193</i>	<i>-485</i>	<i>-379</i>
		<b>Subtotal</b>	<b>-2600</b>		<b>Subtotal</b>	<b>-1057</b>
<b>Bourne TAZ</b>						
3000 (East of Sagamore Flyover)	41	127	72	12	30	24
3187 (Buzzards Bay GIZ)	222	684	384	99	248	194
3087 (SE Bourne Rotary)	184	567	319	82	207	161
<i>Allocation from Mashpee TAZs</i>	<i>447</i>	<i>1378</i>	<i>775</i>	<i>193</i>	<i>485</i>	<i>379</i>

**Table 7: Reallocation of Employment from select Mashpee to Bourne TAZs**

Model Condition	Mashpee Employment		
	3070	3075	3077
2019 Existing Conditions	433	613	508
2045 Unadjusted Conditions	1142	444	1091
2045 Adjusted Conditions	962	444	943
<i>Allocation to Bourne TAZs</i>	<i>-180</i>	<i>N.C.</i>	<i>-148</i>
		<b>Subtotal</b>	<b>-328</b>
<b>Bourne TAZ</b>			
3000 (East of Sagamore Flyover)	56		46
3187 (Buzzards Bay GIZ)	54		46
3087 (SE Bourne Rotary)	70		56
<i>Allocation from Mashpee TAZs</i>	<i>180</i>	<i>0</i>	<i>148</i>

### Future No Build Conditions Sensitivity Case

The purpose of the Sensitivity Case scenario is to test how trends tied to remote working, retirement of the Baby Boomer generation, and other more recent changes in travel behavior may impact traffic volumes within the study area differently from the methods employed in the Base Case scenario. Research into the prevailing trends was completed by FXM Associates and document in their memo “Sensitivity Tests for Travel Demand Modeling,” dated October 8, 2021. These revised demographics were determined to best capture the impact of following major trends:

- Post “great recession” migration trends between 2010-2019 indicate net in-migrations to Barnstable County, but these are not sufficient to outpace natural population decline over this period, continuing the long term trends.
- Migrations of non-retired families to their vacation homes on Cape Cod during the COVID-19 pandemic may have been a one-time phenomenon as many have reportedly returned to their primary residence once in-person schooling resumed.
- In-migration to Cape Cod may trend more towards retired persons moving into the Cape as they are more likely to be able to afford the higher real estate prices.
- These population trends are not anticipated to impact the growth in visitor trips forecasted from the Base Case scenario (0.7% per year). Factors limiting visitor growth could include the parking and occupancy limits of Cape Cod’s major attractions.
- New housing construction on Cape Cod is expected to continue to cater to higher income retirees and people seeking vacation homes (based on trends identified from IRS data), and this will continue the trend of lower-wage workers seeking housing outside of Cape Cod,
- Some conversion of homes from seasonal use to year-round households is expected, but no information indicated it would be higher than the 11,000 homes (~10% of total existing supply) indicated in the stated preference survey conducted by the Cape Cod Commission,
- Ultimately, the overall decrease in population will result in a similar decrease in households, although not to the same level predicted in the original UMDI estimates.
- Total employment levels are expected to stay at 2020 levels through 2045 due to counteracting trends affecting future employment levels.
  - The first trend is the decrease in employment driven by the overall decrease in population (in jobs like education, government services, and grocery stores).
  - The second trend is the growth in jobs related to Cape Cod’s aging population (healthcare, administrative and support services) and popularity as a vacation destination (food services and drinking places, construction of buildings, etc.).
- The relatively strong employment picture compared to the decrease in population is another factor that will increase the number of people commuting to Cape Cod from the mainland for work.

The population, households, and employment levels estimated by FXM Associates based on this research are shown in Table 8 in comparison to 2019 Existing Conditions and the 2045 Future No Build Base Case scenario.

**Table 8: Barnstable County Socio-Economic Forecasts - Comparison of 2019 Existing Conditions to both Future No Build Scenarios**

Model Condition	Population	Households	Employment
2019 Existing Conditions	212,990	94,323	97,672
2045 Base Case (UMDI)	176,007	82,313	75,299
<i>Diff. from Existing</i>	<i>-17.4%</i>	<i>-12.7%</i>	<i>-22.9%</i>
2045 Sensitivity Case (FXM)	192,559	90,323	96,878
<i>Diff. from Existing</i>	<i>-9.6%</i>	<i>-4.2%</i>	<i>-0.8%</i>



## Future No Build Travel Demand Modeling Results:

The traffic volumes modeled for both Future No Build scenarios during the Summer Weekday PM and Summer Weekend Saturday peak hours are shown in Table 9 and Table 10.

**Table 9: Bridge Traffic Volumes - Comparison of 2019 Existing Conditions to both Future No Build Scenarios**

Model Condition	Bourne Bridge North	Bourne Bridge South	Sagamore Bridge North	Sagamore Bridge South	Total Crossings
<b>Summer Weekday PM</b>					
2019 Existing Conditions	1,990	2,185	3,350	2,380	<b>9,905</b>
2045 Base Case (UMDI)	2,695	2,260	3,650	2,550	<b>11,155</b>
<i>Diff. from Existing</i>	35.4%	3.4%	9.0%	7.1%	<b>12.6%</b>
2045 Sensitivity Case (FXM)	2,915	2,285	3,955	2,605	<b>11,760</b>
<i>Diff. from Existing</i>	46.5%	4.6%	18.1%	9.5%	<b>18.7%</b>
<b>Summer Weekend Saturday</b>					
2019 Existing Conditions	1,845	2,640	3,290	2,665	<b>10,440</b>
2045 Base Case (UMDI)	2,185	2,680	3,680	3,375	<b>11,920</b>
<i>Diff. from Existing</i>	18.4%	1.5%	11.9%	26.6%	<b>14.2%</b>
2045 Sensitivity Case (FXM)	2,295	2,710	3,880	3,470	<b>12,355</b>
<i>Diff. from Existing</i>	24.4%	2.7%	17.9%	30.2%	<b>18.3%</b>

**Table 10: Canal Roadway Traffic Volumes - Comparison of 2019 Existing Conditions to both Future No Build Scenarios**

Model Condition	Scenic Highway		Sandwich Rd		Total Canalside
	East	West	East	West	
<b>Summer Weekday PM</b>					
2019 Existing Conditions	1,215	2,125	1,350	1,035	<b>5,725</b>
2045 Base Case (UMDI)	1,825	2,325	1,280	1,575	<b>7,005</b>
<i>Diff. from Existing</i>	50.2%	9.4%	-5.2%	52.2%	<b>22.4%</b>
2045 Sensitivity Case (FXM)	1,840	2,375	1,300	1,685	<b>7,200</b>
<i>Diff. from Existing</i>	51.4%	11.8%	-3.7%	62.8%	<b>25.8%</b>
<b>Summer Weekend Saturday</b>					
2019 Existing Conditions	930	1,590	1,410	935	<b>4,865</b>
2045 Base Case (UMDI)	1,475	1,860	1,275	1,085	<b>5,695</b>
<i>Diff. from Existing</i>	58.6%	17.0%	-9.6%	16.0%	<b>17.1%</b>
2045 Sensitivity Case (FXM)	1,495	1,910	1,305	1,145	<b>5,855</b>
<i>Diff. from Existing</i>	60.8%	20.1%	-7.4%	22.5%	<b>20.3%</b>

The general trends shown in both future scenarios are:

- Highest growth in canal crossings for Bourne Bridge NB traffic volumes
- Highest growth in canal roadways is Scenic Highway eastbound and Sandwich Road westbound.

### General Findings

Evaluation of existing traffic volumes and the INRIX Origin-Destination (OD) information has shown that vehicles prefer not to travel through the Bourne Rotary if they can avoid it. This driver preference has been coded into the travel demand models and is what most directly leads to the decrease in canal roadway volumes on Sandwich Road eastbound in both scenarios.

It is also important to note that both scenarios show growth over existing conditions but are lower increases in traffic volume when compared to the 2040 Future No Build volumes from the previous planning study. This is due to the following factors:

- Calibration of this travel demand model based on INRIX origin-destination traffic flows. This information was not available during the planning study. The calibration of the prior model resulted in roughly 40% of the traffic on the bridges coming from the areas immediately adjacent to the two canal bridges, primarily from within the Town of Bourne. The new INRIX OD data indicated that only about 26% of the traffic on the bridges are local traffic.
- The prior study was based on an earlier set of existing 2014 socio-economic data and available 2040 socio-economic forecasts from UMDI. While the forecasts indicated an overall decline for Barnstable County, it indicated an increase in population and employment for the Town of Bourne between 2014 and 2040. Those forecasts were revised by UMDI and now indicate a decline for the Town of Bourne. The current model is based on the existing 2019 socio-economic data and that recently updated 2040 socio-economic forecasts.

The higher level of local traffic combined with growth in Bourne-related trips resulted in the prior study having higher bridge volumes than what is currently predicted. We have confidence in the accuracy of this model based on the following tests:

- The current model has been calibrated to 2019 traffic volumes on the bridges but also for the 2019 origin-destination patterns based on probe data collected by INRIX which results in a more reasonable split in bridge traffic between regional and local trips.
- Total network volume of the 2045 Future No Build models is higher than the 2040 Future No Build network from the previous study, further strengthening the argument that the added calibration steps and revised socio-economic projects from UMDI shows fewer bridge crossings in the network than in the prior planning study.

### **Conclusion**

The Sensitivity Case scenario should be used for the Future No Build analysis and testing of potential roadway alternatives. Travel patterns are similar for each 2045 Future No Build scenario, but the Sensitivity Case reflects higher overall traffic volumes and provides a more conservative baseline for the comparison of alternatives.

# Attachment 6 Environmental Documentation and Agency Coordination

- 6.1 Bourne Priority Habitats and Estimated Habitats Map, NHESP 15th Edition Natural Heritage Atlas
- 6.2 Previous USFWS Coordination
- 6.3 Previous NMFS Coordination
- 6.4 Previous EPA Coordination
- 6.5 Previous CZM Coordination

## 6.1 Bourne Priority Habitats and Estimated Habitats Map, NHESP 15<sup>th</sup> Edition Natural Heritage Atlas



## BOURNE

### Priority Habitats and Estimated Habitats

*Priority Habitats, for use with the MA Endangered Species Act Regulations (321 CMR 10)*  
*Estimated Habitats, for use with the MA Wetlands Protection Act Regulations (310 CMR 10)*  
 Effective August 1, 2021

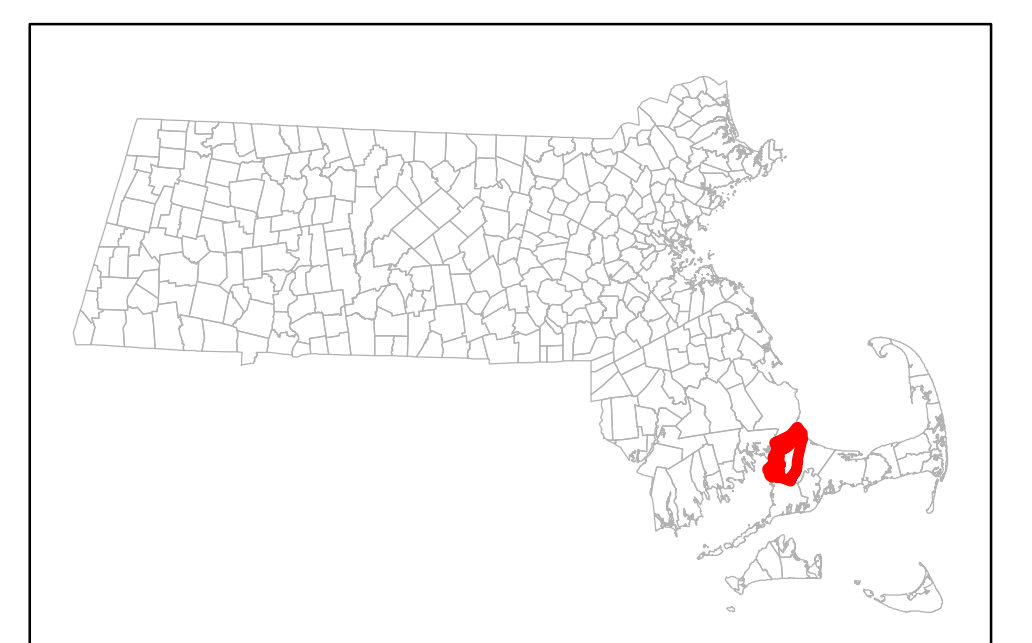


**Natural Heritage & Endangered Species Program**  
 1 Rabbit Hill Road, Westborough, MA 01581  
 tel: (508) 389-6360; fax: (508) 389-7890

**Data Sources:**  
 Priority Habitats and Estimated Habitats: created by NHESP in 2021.  
 Certified Vernal Pools: created by NHESP, July 20, 2021.  
 Town Boundaries: 1:25,000 community boundary data, from MassGIS (updated March, 2017).  
 Roads: MassDOT roads, from MassGIS (updated 2018).  
 Digital Orthophoto: 15cm resolution, taken in 2019, from MassGIS.

<p> Priority Habitat of Rare Species</p> <p>Project or Activity falls within Priority Habitat only:        - You must file directly with NHESP pursuant to Massachusetts Endangered Species Act (MESA)</p> <p>Examples of projects: single family home, subdivision, commercial building, widening of driveway/road, beaver dam removal, etc.</p> <p>Some projects or activities may be exempt from MESA filing: see 321 CMR 10.14</p>	<p> Priority Habitat of Rare Species and also Estimated Habitat of Rare Wildlife</p> <p>Project or Activity is within BOTH Estimated Habitat and Priority Habitat:        - Is a Notice of Intent (NOI) under wetlands regulations required?        -Yes          Send copy of NOI to NHESP and must also file under MESA (streamlined MESA-NOI filing option available)        -No          MESA filing only (see 'Priority Habitat' details at left)</p>	<p> Certified Vernal Pools (as of July 20, 2021)</p> <p> Town Boundary</p> <p><b>Transportation:</b></p> <p> Interstate</p> <p> U.S. Highway</p> <p> State Route</p> <p> Non-numbered Route</p> <p> Railroad</p>
--	--	--

*For more information, see our website at [www.mass.gov/nhesp](http://www.mass.gov/nhesp)*



Commonwealth of Massachusetts  
 Charlie Baker, Governor  
 Karyn Polito, Lt. Governor  
 Executive Office of Energy & Environmental Affairs  
 Kathleen A. Theoharides, Secretary

## 6.2 Previous USFWS Coordination



# United States Department of the Interior



## FISH AND WILDLIFE SERVICE

New England Field Office  
70 Commercial Street, Suite 300  
Concord, NH 03301-5087  
<http://www.fws.gov/newengland>

December 23, 2019

Wendy Gendron  
Programs and Project Management Division  
Civil Works/IIS Project Management Branch  
U.S. Army Corps of Engineers  
New England District  
696 Virginia Road  
Concord, MA 01742-2751

Ref: Major Rehabilitation Evaluation Report and Environmental Assessment  
for the Bourne and Sagamore Highway Bridges (Bourne, MA)  
TAILS: 2020-I-0427

Dear Ms. Gendron:

This responds to your correspondence, dated November 5, 2019, and received in our office on November 12, 2019, requesting our review of the above referenced documents. Your request and our response are made pursuant to section 7 of the Endangered Species Act of 1973, as amended (87 Stat. 884, as amended; 16 U.S.C. 1531, *et seq.*; ESA), and section 2(b) of the Fish and Wildlife Coordination Act of 1934, as amended (16 U.S.C. 661-667e).

The U.S. Army Corps of Engineers (Corps) developed an Environmental Assessment (EA) that accompanies the Major Rehabilitation Evaluation Report as the first phase in determining the future of the Cape Cod Canal Highway Bridges. This phase examines potential alternatives at a conceptual level; the Corps will develop a more definitive design in the next phase of analysis. The footprint of the proposed project will include the Bourne and Sagamore bridges plus a 500-foot buffer zone around each, totaling 305 acres.

The proposed project, regardless of the final alternative selection and subsequent design, will largely occur within the footprint of existing developed land (i.e., the bridges and their supporting structures), and therefore, is unlikely to have substantial impacts on wildlife or their habitat. However, we encourage the Corps to consider listed and other high priority species during the planning and implementation of this project, and to pursue any design elements that would minimize impacts and/or provide beneficial impacts to these species or their habitats.

*“At-Risk” Species*

The following species are not currently listed under the ESA, but they are considered to be at-risk of needing that protection, and they could occur in the vicinity of the proposed project: New England cottontail (*Sylvilagus transitionalis*), frosted elfin butterfly (*Callophrys irus*), wood turtle (*Glyptemys insculpta*), and spotted turtle (*Clemmys guttata*). More information and recommendations for specific conservation measures that may be taken to support these species is available from the Massachusetts Division of Fisheries and Wildlife (<https://www.mass.gov/info-details/list-of-endangered-threatened-and-special-concern-species>).

*Federally Listed Species*

The proposed project falls within the range of the federally threatened northern long-eared bat (NLEB; *Myotis septentrionalis*), piping plover (*Charadrius melodus*), and red knot (*Calidris canutus*); and the federally endangered northern (Plymouth) red-bellied cooter (*Pseudemys rubriventris*), American chaffseed (*Schwalbea americana*), and roseate tern (*Sterna dougallii dougallii*). With the exception of the NLEB, the Corps determined the proposed project, regardless of the final alternative selection and subsequent design, will have no effect on these species, because habitat for these species is not present in the project area.

In regard to the NLEB, we recommend the Corps consult with the Service, pursuant to section 7 of the ESA, during the design phase of the project to determine if NLEB are present and identify measures to minimize potential impact, as documented on page 39 of the EA.

Thank you for your coordination. We look forward to continuing to work with you as this project develops. Please contact Ms. Cindy Corsair of this office at 401-213-4416 if we can be of further assistance.

Sincerely yours,



*acting for*  
Thomas R. Chapman  
Supervisor  
New England Field Office

cc: Reading file  
ES: CCorsair:jd:12-23-19:401-213-4416



### 6.3 Previous NMFS Coordination

**From:** [Bradley, Rosemarie A CIV USARMY CENAE \(US\)](#)  
**To:** [Decelles, Elizabeth C CIV USARMY CENAE \(US\)](#)  
**Subject:** FW: [Non-DoD Source] Re: Cape Cod Canal Bridges Agency Phone Meeting Record  
**Date:** Wednesday, August 7, 2019 7:49:27 AM

---

-----Original Message-----

From: Zachary Jylkka - NOAA Federal [<mailto:zachary.jylkka@noaa.gov>]  
Sent: Thursday, July 25, 2019 9:42 AM  
To: Bradley, Rosemarie A CIV USARMY CENAE (US) <[Rosemarie.A.Bradley@usace.army.mil](mailto:Rosemarie.A.Bradley@usace.army.mil)>  
Subject: [Non-DoD Source] Re: Cape Cod Canal Bridges Agency Phone Meeting Record

Hi Rosemarie,

This looks good to me. Thank you for giving me an opportunity to review.

Regards,  
Zach

On Tue, Jul 16, 2019 at 5:10 PM Bradley, Rosemarie A CIV USARMY CENAE (US) <[Rosemarie.A.Bradley@usace.army.mil](mailto:Rosemarie.A.Bradley@usace.army.mil) <<mailto:Rosemarie.A.Bradley@usace.army.mil>> > wrote:

Hi Zach,  
We are following up to ensure we have captured our phone meeting details accurately - Please see attached.  
Thanks,  
Rosemarie

-----  
Rosemarie Bradley, Ph.D.  
Marine Biologist  
US Army Corps of Engineers  
New England District  
696 Virginia Road  
Concord, MA 01742  
978-318-8127  
[rosemarie.a.bradley@usace.army.mil](mailto:rosemarie.a.bradley@usace.army.mil) <<mailto:rosemarie.a.bradley@usace.army.mil>>

--

Zach Jylkka  
Fisheries Biologist

Protected Resources Division  
Greater Atlantic Regional Fisheries Office NOAA Fisheries Gloucester, MA 01930 [zachary.jylkka@noaa.gov](mailto:zachary.jylkka@noaa.gov)  
<<mailto:zachary.jylkka@noaa.gov>>

office: (978) 282-8467

Pronouns: (he/him/his)

For additional ESA Section 7 information and Critical Habitat guidance, please see:  
Blocked[www.greateratlantic.fisheries.noaa.gov/protected/section7](http://www.greateratlantic.fisheries.noaa.gov/protected/section7)  
<Blocked<http://www.greateratlantic.fisheries.noaa.gov/protected/section7>>

## Meeting Record

**Subject:** Cape Cod Canal (CCC) Bridges MRER, EA and NOAA ESA and EFH Coordination

**Attendees:** Zach Jylkka, Fisheries Biologist, Protected Resources Division, GARFO, NOAA; Craig Martin, USACE Project Manager, David Oster, USACE Biologist, Rosemarie Bradley, USACE Marine Biologist

**Date:** Monday, May 20, 2019

### Summary

- Phase I of the CCC Bridges project is the Major Rehabilitation Evaluation Report (MRER) decision document and accompanying EA for this phase of the project
- Phase II of the Bridges project will be the design and construction phase and a supplemental EA will be prepared for this phase as well
- It is too early in the project development stage to enter into consultation. NOAA would like us to wait until we are further along in the process before we initiate consultation. They cannot provide specific comments for this phase of the project
- We can determine “areas of potential impacts” and species to be considered including:
  - Atlantic Sturgeon
  - Short nose Sturgeon
  - 4 species of sea turtles including Kemps Ridley and Loggerhead who are susceptible to “cold-stunning”
  - North Atlantic Right Whale – biggest concern
  - Fin Whale
- Sturgeon have the potential to transit through the canal, but none have been documented in the Canal in the past
- Sea turtles are not expected to be present in the canal. They typically migrate May – end of October
- Corps needs to consider Kemps Ridley and Loggerhead during cold stunning season – Mid/late October – December; sometimes they get caught in Cape Cod Bay
- Right whales on occasion transit through the canal, and are the biggest concern, so we need to address in-water work.
  - How will the bridges be demolished? If blasting will occur to remove old bridge piers, we need to look at potential impacts.
  - Will barges be used to install new bridges? If so, need a plan if right whales enter canal while barges are there
  - Existing plan - shut down the canal and escort the whale through
  - Any interaction with a right whale – need to address how to avoid “harassment” – identify measures
  - Look at the “Test Tidal Turbine” for sample language and mitigation measures
  - Look at time of year restrictions – January-May in Cape Cod Bay
- Identify general types of in-water stressors and plan to consider these – vehicle traffic, noise, turbidity etc.
- NOAA can’t make effects determination at this time
- Zach will look at what we draft for Phase I of the project and accompanying EA and will fill in Alison. We will follow-up with Alison after Zach speaks with her

**From:** [vonOettingen, Susi](#)  
**To:** [Bradley, Rosemarie A CIV USARMY CENAE \(US\)](#)  
**Cc:** [Eliese Dykstra](#)  
**Subject:** [Non-DoD Source] Re: [EXTERNAL] Cape Cod Canal Highway Bridges Major Rehab Evaluation Report (MRER) Call  
**Date:** Monday, April 1, 2019 7:20:09 AM

---

Hi Rosemarie,

Thank you for a great summary of our discussion. Yes, I think you covered all of the pertinent points.

Susi

\*\*\*\*\*

Susi von Oettingen  
Endangered Species Biologist  
New England Field Office  
70 Commercial Street, Suite 300  
Concord, NH 03301  
(W) 603-227-6418  
(Fax) 603-223-0104

Blockedwww.fws.gov/newengland <Blockedhttp://www.fws.gov/newengland>

On Tue, Mar 26, 2019 at 4:04 PM Bradley, Rosemarie A CIV USARMY CENAE (US)  
<Rosemarie.A.Bradley@usace.army.mil <<mailto:Rosemarie.A.Bradley@usace.army.mil>> > wrote:

Hi Susi,  
I wanted to make sure I accurately captured our recent phone conversation.

To summarize:

- \*This phase of the project ("Phase I") is solely a decision document to determine whether major rehabilitation or replacement of the Bourne and Sagamore bridges is the recommended path forward
- \*As there is no concrete project yet , there are no impacts to species for this phase (Phase I)
- \*We will inventory what species are present and those that utilize the canal
- \*We should include migratory birds and transient birds - Plovers, Red knot and Roseate terns
- \*Roseate terns are known to use the canal as a flyway
- \*No need to consider American chaffseed or Northern red-bellied cooter
- \*Bats are known to roost in bridges. FWS recommends a "bridge survey" when we move on to the design and construction phase
- \*In future phases we will need to consider staging areas, tree clearing, and potential time of year restrictions
- \*FWS has numerous radio-tracked bird reports and data if needed

Is there anything I have missed?  
Rosemarie

-----  
Rosemarie Bradley, Ph.D.

Marine Biologist  
US Army Corps of Engineers  
New England District  
696 Virginia Road  
Concord, MA 01742  
978-318-8127  
rosemarie.a.bradley@usace.army.mil <<mailto:rosemarie.a.bradley@usace.army.mil>>



**UNITED STATES DEPARTMENT OF COMMERCE**  
**National Oceanic and Atmospheric Administration**  
NATIONAL MARINE FISHERIES SERVICE  
GREATER ATLANTIC REGIONAL FISHERIES OFFICE  
55 Great Republic Drive  
Gloucester, MA 01930-2276

DEC 20 2019

Wendy Gendron  
Chief, Civil Works/IIS Branch  
Department of the Army, Corps of Engineers  
New England District  
696 Virginia Road  
Concord, MA 01742-2751

Re: Draft Major Rehabilitation Evaluation Report and Environmental Assessment for the Bourne and Sagamore Bridges

Dear Ms. Gendron:

Thank you for your letter, dated November 6, 2019, requesting our review of the Draft Major Rehabilitation Evaluation Report (MRER) and Environmental Assessment (EA) for the Bourne and Sagamore Bridges spanning the Cape Cod Canal.

As we noted in an email to Rosemarie Bradley on November 19, 2019, the sections of the EA addressing Endangered Species Act (ESA) resources accurately catalog the listed species and critical habitat under our jurisdiction that are present in your project action area. You also correctly included that our chief concern, regardless of the selected alternative, is the safe passage of the endangered North Atlantic right whale, which occasionally migrate through the Canal. It is our understanding that you will work with us to develop protection measures for ESA-listed species during the design phase of the project. We would like to clarify that while you include humpback whales among the listed species that may be present in your action area, the distinct population segment (DPS) of humpback whales expected to be present in the action area (West Indies DPS) is no longer listed as threatened or endangered under the ESA (though it is still protected under the Marine Mammal Protection Act).

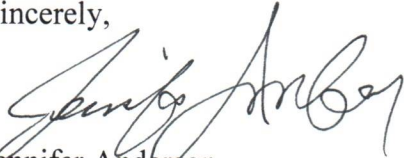
Your Draft MRER EA also accurately identifies the project elements that will be of highest concern for potential impacts to essential fish habitat (EFH). We look forward to working with you to ensure impacts to EFH are minimized as the project is fully developed. We do note that there appear to be some issues with the included list of managed fish species with designated EFH in the project area (EA Table 2). The list of species embedded in EA Figure 9, more accurately identifies the species with designated EFH. However, it is missing spiny dogfish and northern shortfin squid. The figure list also states that all life history stages of the species listed occur, but there are multiple species that do not have all life history stages designated in the project area. We would be happy to work with you to develop the full list of species with designated EFH in the project area.

Thank you for the opportunity to review and comment on the Draft MRER EA. We look forward to our continued work with you. If you have any questions regarding this matter, please contact



Alison Verkade at (978) 281-9266 or by email at Alison.Verkade@noaa.gov for information regarding Essential Fish Habitat or other trust resources, or Zach Jylkka at (978) 282-8467 or by email at Zachary.Jylkka@noaa.gov for information regarding threatened and endangered species listed by us under the ESA.

Sincerely,



Jennifer Anderson  
Assistant Regional Administrator  
for Protected Resources

EC: Verkade, NMFS HCD; Bradley, Martin, Randall, USACE  
File Code: H:\Section 7 Team\Section 7\Non-Fisheries\ACOE\Informal\2019\New England\Cape Cod Canal Bridge Replacement\Pre-Consultation



## 6.4 Previous EPA Coordination



UNITED STATES ENVIRONMENTAL PROTECTION AGENCY

REGION 1  
5 POST OFFICE SQUARE, SUITE 100  
BOSTON, MA 02109-3912

OFFICE OF THE  
REGIONAL ADMINISTRATOR

November 14, 2019

Craig Martin  
U.S. Army Corps of Engineers  
New England District  
696 Virginia Road  
Concord, MA 01742-2751

RE: Cape Cod Canal Highway Bridges Draft Major Rehabilitation Evaluation Report and Draft Environmental Assessment, Bourne, Massachusetts

Dear Mr. Martin:

We are writing in response to your October 9, 2019 30-day Public Notice requesting comments on the Draft Environmental Assessment (EA) for the Cape Cod Canal Highway Bridges in Bourne, Massachusetts. We submit the following response to the EA in accordance with our responsibilities under the National Environmental Policy Act (NEPA) and Section 309 of the Clean Air Act.

The EA was prepared to support decision-making by the U.S. Army Corps of Engineers regarding the identification of a long-term maintenance and operation strategy for the Bourne and Sagamore bridges which were originally constructed in the 1930s. Specifically, the EA evaluates "...whether continued repair and maintenance, major rehabilitation, or replacement of the bridges with new structures will provide safe, efficient transit for vehicular traffic across the Cape Cod Canal." Alternatives considered in the EA include continued bridge repair and maintenance, major rehabilitation, or replacement of the bridges. The EA identifies replacement of both the Bourne and Sagamore Bridges (with four primary and two auxiliary lanes) as the preferred alternative. We have no objections to the selection of the bridge replacement alternative. While the general information provided in the EA is suitable to support decision-making regarding the future plans for both bridges it does not detail the specific impacts of the replacement work. Based on our review of the EA it is our understanding that this information will be provided as part of future NEPA analysis and documentation for the project. As such we recommend that the next phase of the NEPA analysis for the project provide:

- A specific description of staging/laydown areas and alternatives considered for this component of the project construction and demolition work.
- A specific description of construction sequencing for the bridge replacement projects with a focus on the potential for environmental and host community effects including affects on local and regional traffic.

- A comprehensive description of impacts to the Cape Cod Canal and wetland areas affected by the proposed work including a discussion of measures taken to avoid or minimize impacts through project design or best management practices. This discussion should also expand on the discussion in the current EA regarding potential impacts to Nightingale Pond.
- A specific description of how stormwater will be managed during construction and operation of the proposed replacement bridges. The analysis should address both quantitative and qualitative aspects of stormwater management over the life of the proposed project and demonstrate how new bridges will meet water quality/stormwater management regulations. A comparison of existing stormwater management techniques at each bridge location to the proposed condition will serve to highlight additional benefits of the bridge replacement work.

We are willing to work with the Corps as appropriate to help determine appropriate ways to address the issues identified in this letter during the next phase of the project. Please let us know how we can be of assistance. We would also appreciate the opportunity to review and comment on the NEPA scope of analysis for the next phase of the project when appropriate. Thank you for the opportunity to comment on this EA. Please contact me at 617-918-1025 with any comments or questions.

Sincerely,



Timothy L. Timmermann  
Director, Office of Environmental Review

# 6.5 Previous CZM Coordination



**THE COMMONWEALTH OF MASSACHUSETTS**  
EXECUTIVE OFFICE OF ENERGY AND ENVIRONMENTAL AFFAIRS  
OFFICE OF COASTAL ZONE MANAGEMENT  
251 Causeway Street, Suite 800, Boston, MA 02114-2136  
(617) 626-1200 FAX: (617) 626-1240

November 26, 2019

Mr. Craig Martin  
U.S. Army Corps of Engineers  
New England District  
696 Virginia Road  
Concord, MA 01742-2751

Re: CZM Federal Consistency Review of Major Rehabilitation Evaluation Report and accompanying Draft Environmental Assessment for the Cape Cod Canal Bridges, Cape Cod Canal Federal Navigation Project; Bourne.

Dear Mr. Martin:

The Massachusetts Office of Coastal Zone Management (CZM) has completed its review of the Major Rehabilitation Evaluation Report and accompanying Draft Environmental Assessment to ensure consistency with CZM enforceable program policies.

Based upon our review of applicable information, we concur with your certification and find that the activity as proposed is consistent with the CZM enforceable program policies.

If the above-referenced project is modified in any manner, including any changes resulting from permit, license or certification revisions, including those ensuing from an appeal, or the project is noted to be having effects on coastal resources or uses that are different than originally proposed, it is incumbent upon the proponent to notify CZM, submit an explanation of the nature of the change pursuant to 15 CFR 930, and submit any modified state permits, licenses, or certifications. CZM will use this information to determine if further federal consistency review is required.

Thank you for your cooperation with CZM.

Sincerely,

Lisa Berry Engler  
Director

RLB/pb  
CZM# 18834



# Attachment 7 Historic Agency and Tribal Consultation and Documentation

7.1 Previous Historic Agency and Tribal Consultation

7.2 Programmatic Agreement between the USACE and the MA SHPO, March 11, 2022

## 7.1 Previous Historic Agency and Tribal Consultation



DEPARTMENT OF THE ARMY  
 US ARMY CORPS OF ENGINEERS  
 NEW ENGLAND DISTRICT  
 696 VIRGINIA ROAD  
 CONCORD MA 01742-2751

RECEIVED

JUL 24 2019

MASS. HIST. COMM

RC.66038

July 17, 2019

Planning Division  
 Evaluation Branch

Ms. Brona Simon, State Historic Preservation Officer  
 Massachusetts Historic Commission  
 220 Morrissey Boulevard  
 Boston, MA 02125

CONCURRENCE. *Simon*  
 8/22/19  
 BRONA SIMON  
 STATE HISTORIC  
 PRESERVATION OFFICER  
 MASSACHUSETTS  
 HISTORICAL COMMISSION

Dear Ms. Simon:

The U.S. Army Corps of Engineers (Corps), New England District, is preparing a multi-year Major Rehabilitation Evaluation Study of the Bourne and Sagamore highway bridges spanning the Cape Cod Canal. The study will result in a Major Rehabilitation Evaluation Report (MRER). The MRER will provide the basis of decision making for the Corps and Congress to determine the most cost-effective, safe alternative for critical public transportation access across the Cape Cod Canal.

As part of the MRER, the Corps is preparing an Environmental Assessment (EA) to analyze the potential environmental effects associated with the project. The major rehabilitation study will analyze alternatives to either repair or replace the existing deteriorated Bourne and Sagamore Bridges. The National Environmental Policy Act (NEPA) survey areas are shown in the attached figure.

Currently, the Corps believes that the rehabilitation of the Bourne and Sagamore bridges should have no adverse effect to the bridges and no effect on local historic districts, individual buildings or known and unknown archaeological sites. The major rehabilitation will include replacement of the bridge superstructure, deck replacement, including stringer replacement, abutment span replacement, exterior gusset plate retrofits, interior gusset plate repairs, miscellaneous concrete repairs, suspender cable replacement, paving, and painting. The bridges would continue in their current footprints, and while changes would be made to the bridges, they will look the same after rehabilitation as materials will be replaced in-kind. This effects determination is contingent on the use of previously disturbed laydown and staging areas. If new areas are chosen, an intensive archaeological survey may be required.

During this phase, based on the research completed to date, the replacement of the Bourne and Sagamore Bridges would have an adverse effect on the bridges and at least two identified archaeological sites, possible unidentified archaeological resources,

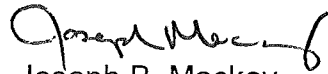


and several historic districts. The effects would be indirect (visual and/or viewshed) as well as direct (possible archaeological sites).

The MRER decision document and accompanying NEPA document constitutes the initial phase of the major rehabilitation study. Based on the outcome of this study and once an alternative to either repair or replace the existing bridges has been identified, additional analysis will be completed that will allow for more detailed review of project related impacts. Additional coordination will take place with SHPO at that time.

We are requesting your comments on our preliminary determinations of effect. If you have any questions or comments, please contact Kate Atwood, staff archaeologist at (978)318-8537 or via email at [Kathleen.a.atwood@usace.army.mil](mailto:Kathleen.a.atwood@usace.army.mil).

Sincerely,



Joseph B. Mackay  
Acting Chief, Evaluation Branch

Enclosure

Similar letters sent to:

Ms. Bettina Washington, Tribal Historic Preservation Officer  
Wampanoag Tribe of Gay Head (Aquinnah)  
20 Black Brook Road  
Aquinnah, MA 02535

Mr. David Weeden, Tribal Historic Preservation Officer  
Mashpee Wampanoag Tribe  
483 Great Neck Road South  
Mashpee, MA 02649



DEPARTMENT OF THE ARMY  
US ARMY CORPS OF ENGINEERS  
NEW ENGLAND DISTRICT  
696 VIRGINIA ROAD  
CONCORD MA 01742-2751

July 17, 2019

Planning Division  
Evaluation Branch

Ms. Brona Simon, State Historic Preservation Officer  
Massachusetts Historic Commission  
220 Morrissey Boulevard  
Boston, MA 02125

Dear Ms. Simon:

The U.S. Army Corps of Engineers (Corps), New England District, is preparing a multi-year Major Rehabilitation Evaluation Study of the Bourne and Sagamore highway bridges spanning the Cape Cod Canal. The study will result in a Major Rehabilitation Evaluation Report (MRER). The MRER will provide the basis of decision making for the Corps and Congress to determine the most cost-effective, safe alternative for critical public transportation access across the Cape Cod Canal.

As part of the MRER, the Corps is preparing an Environmental Assessment (EA) to analyze the potential environmental effects associated with the project. The major rehabilitation study will analyze alternatives to either repair or replace the existing deteriorated Bourne and Sagamore Bridges. The National Environmental Policy Act (NEPA) survey areas are shown in the attached figure.

Currently, the Corps believes that the rehabilitation of the Bourne and Sagamore bridges should have no adverse effect to the bridges and no effect on local historic districts, individual buildings or known and unknown archaeological sites. The major rehabilitation will include replacement of the bridge superstructure, deck replacement, including stringer replacement, abutment span replacement, exterior gusset plate retrofits, interior gusset plate repairs, miscellaneous concrete repairs, suspender cable replacement, paving, and painting. The bridges would continue in their current footprints, and while changes would be made to the bridges, they will look the same after rehabilitation as materials will be replaced in-kind. This effects determination is contingent on the use of previously disturbed laydown and staging areas. If new areas are chosen, an intensive archaeological survey may be required.

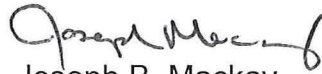
During this phase, based on the research completed to date, the replacement of the Bourne and Sagamore Bridges would have an adverse effect on the bridges and at least two identified archaeological sites, possible unidentified archaeological resources,

and several historic districts. The effects would be indirect (visual and/or viewshed) as well as direct (possible archaeological sites).

The MRER decision document and accompanying NEPA document constitutes the initial phase of the major rehabilitation study. Based on the outcome of this study and once an alternative to either repair or replace the existing bridges has been identified, additional analysis will be completed that will allow for more detailed review of project related impacts. Additional coordination will take place with SHPO at that time.

We are requesting your comments on our preliminary determinations of effect. If you have any questions or comments, please contact Kate Atwood, staff archaeologist at (978)318-8537 or via email at [Kathleen.a.atwood@usace.army.mil](mailto:Kathleen.a.atwood@usace.army.mil).

Sincerely,



Joseph B. Mackay  
Acting Chief, Evaluation Branch

Enclosure

Similar letters sent to:

Ms. Bettina Washington, Tribal Historic Preservation Officer  
Wampanoag Tribe of Gay Head (Aquinnah)  
20 Black Brook Road  
Aquinnah, MA 02535

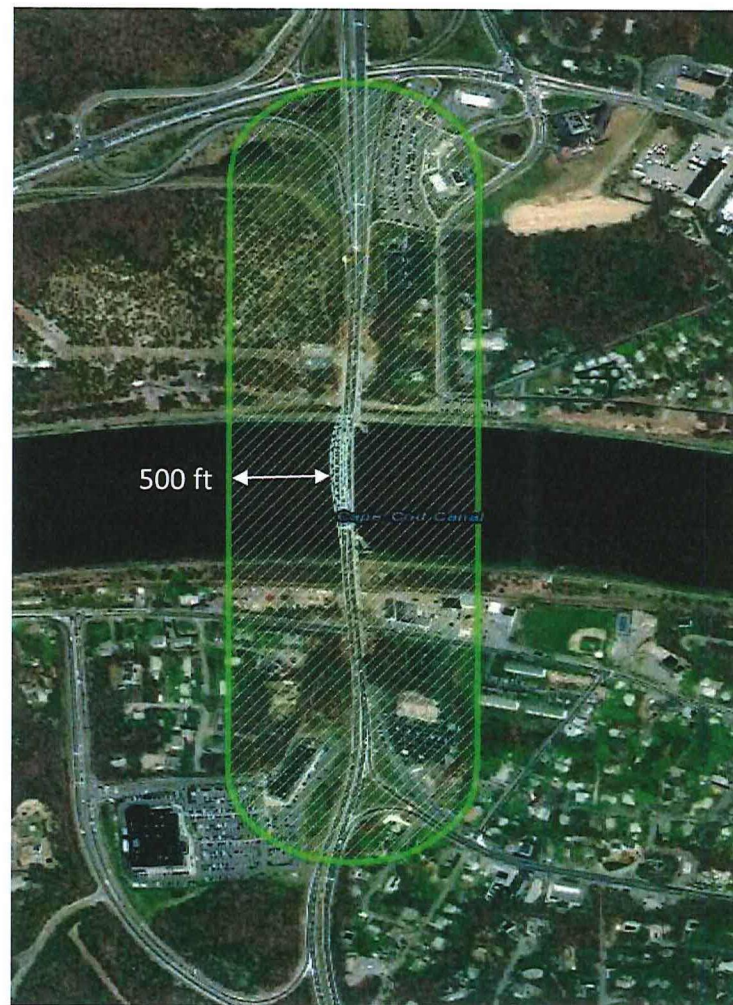
Mr. David Weeden, Tribal Historic Preservation Officer  
Mashpee Wampanoag Tribe  
483 Great Neck Road South  
Mashpee, MA 02649

# Map of Existing Bridges and NEPA Survey Areas

## BOURNE BRIDGE



## SAGAMORE BRIDGE



MAJOR REHABILITATION EVALUATION STUDY Cape Cod Canal Bridges





DEPARTMENT OF THE ARMY  
US ARMY CORPS OF ENGINEERS  
NEW ENGLAND DISTRICT  
696 VIRGINIA ROAD  
CONCORD MA 01742-2751

September 24, 2019

Planning Division  
Evaluation Branch

David S. Robinson, Chief Archaeologist, State Underwater Archaeologist  
Massachusetts Board of Underwater Archaeological Resources  
251 Causeway Street, Suite 800  
Boston, MA 02114-2199

Dear Mr. Robinson:

The U.S. Army Corps of Engineers (Corps), New England District, is preparing a multi-year Major Rehabilitation Evaluation Study of the Bourne and Sagamore highway bridges spanning the Cape Cod Canal. The study will result in a Major Rehabilitation Evaluation Report (MRER). The MRER will provide the basis of decision making for the Corps and Congress to determine the most cost-effective, safe alternative for critical public transportation access across the Cape Cod Canal.

As part of the MRER, the Corps is preparing an Environmental Assessment (EA) to analyze the potential environmental effects associated with the project. The major rehabilitation study will analyze alternatives to either repair or replace the existing deteriorated Bourne and Sagamore Bridges. The National Environmental Policy Act (NEPA) survey areas are shown in the attached figure for both rehabilitation and replacement.

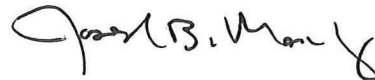
Currently, the Corps believes that the rehabilitation of the Bourne and Sagamore bridges should have no adverse effect to the bridges and no effect on local historic districts, individual buildings or known and unknown archaeological sites. The major rehabilitation will include replacement of the bridge superstructure, deck replacement, including stringer replacement, abutment span replacement, exterior gusset plate retrofits, interior gusset plate repairs, miscellaneous concrete repairs, suspender cable replacement, paving, and painting. The bridges would continue to operate in their current footprints, and while changes would be made to the bridges, they will look the same after rehabilitation as materials will be replaced in-kind. This effects determination is contingent on the use of previously disturbed laydown and staging areas. If new areas are chosen, an intensive archaeological survey may be required.

During this initial evaluation, based on the research completed to date, the replacement of the Bourne and Sagamore Bridges would have an adverse effect on the bridges and at least two identified archaeological sites, possible unidentified archaeological resources, and several historic districts. The effects would be indirect (visual and/or viewshed) as well as direct (possible archaeological sites).

The MRER decision document and accompanying NEPA document constitutes the initial phase of the major rehabilitation study. Based on the outcome of this study and an alternative to either repair or replace the existing bridges has been identified, additional analysis will be completed that will allow for more detailed review of project related impacts. Additional coordination will take place with your office at that time.

We are requesting your comments on our preliminary determinations of effect. If you have any questions or comments, please contact Kate Atwood, staff archaeologist at (978) 318-8537 or via email at Kathleen.a.atwood@usace.army.mil.

Sincerely,



Joseph B. Mackay  
Acting Chief, Evaluation Branch

Enclosure

Similar letters sent to:

Ms. Bettina Washington, Tribal Historic Preservation Officer  
Wampanoag Tribe of Gay Head (Aquinnah)  
20 Black Brook Road  
Aquinnah, MA 02535

Mr. David Weeden, Tribal Historic Preservation Officer  
Mashpee Wampanoag Tribe  
483 Great Neck Road South  
Mashpee, MA 02649

Ms. Brona Simon, State Historic Preservation Officer  
Massachusetts Historic Commission  
220 Morrissey Boulevard  
Boston, MA 02125

# Map of Existing Bridges and NEPA Survey Areas

## BOURNE BRIDGE



## SAGAMORE BRIDGE



MAJOR REHABILITATION EVALUATION STUDY Cape Cod Canal Bridges





DEPARTMENT OF THE ARMY  
US ARMY CORPS OF ENGINEERS  
NEW ENGLAND DISTRICT  
696 VIRGINIA ROAD  
CONCORD MA 01742-2751

July 17, 2019

Planning Division  
Evaluation Branch

Ms. Bettina Washington, Tribal Historic Preservation Officer  
Wampanoag Tribe of Gay Head (Aquinnah)  
20 Black Brook Road  
Aquinnah, MA 02535

Dear Ms. Washington:

The U.S. Army Corps of Engineers (Corps), New England District, is preparing a multi-year Major Rehabilitation Evaluation Study of the Bourne and Sagamore highway bridges spanning the Cape Cod Canal. The study will result in a Major Rehabilitation Evaluation Report (MRER). The MRER will provide the basis of decision making for the Corps and Congress to determine the most cost-effective, safe alternative for critical public transportation access across the Cape Cod Canal.

As part of the MRER, the Corps is preparing an Environmental Assessment (EA) to analyze the potential environmental effects associated with the project. The major rehabilitation study will analyze alternatives to either repair or replace the existing deteriorated Bourne and Sagamore Bridges. The National Environmental Policy Act (NEPA) survey areas are shown in the attached figure.

Currently, the Corps believes that the rehabilitation of the Bourne and Sagamore bridges should have no adverse effect to the bridges and no effect on local historic districts, individual buildings or known and unknown archaeological sites. The major rehabilitation will include replacement of the bridge superstructure, deck replacement, including stringer replacement, abutment span replacement, exterior gusset plate retrofits, interior gusset plate repairs, miscellaneous concrete repairs, suspender cable replacement, paving, and painting. The bridges would continue in their current footprints, and while changes would be made to the bridges, they will look the same after rehabilitation as materials will be replaced in-kind. This effects determination is contingent on the use of previously disturbed laydown and staging areas. If new areas are chosen, an intensive archaeological survey may be required.

During this phase, based on the research completed to date, the replacement of the Bourne and Sagamore Bridges would have an adverse effect on the bridges and at least two identified archaeological sites, possible unidentified archaeological resources,

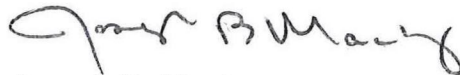


and several historic districts. The effects would be indirect (visual and/or viewshed) as well as direct (possible archaeological sites).

The MRER decision document and accompanying NEPA document constitutes the initial phase of the major rehabilitation study. Based on the outcome of this study and once an alternative to either repair or replace the existing bridges has been identified, additional analysis will be completed that will allow for more detailed review of project related impacts. Additional coordination will take place with SHPO at that time.

We are requesting your comments on our preliminary determinations of effect. If you have any questions or comments, please contact Kate Atwood, staff archaeologist at (978)318-8537 or via email at [Kathleen.a.atwood@usace.army.mil](mailto:Kathleen.a.atwood@usace.army.mil).

Sincerely,



Joseph B. Mackay  
Acting Chief, Evaluation Branch

Enclosure

Similar letters sent to:

Mr. David Weeden, Tribal Historic Preservation Officer  
Mashpee Wampanoag Tribe  
483 Great Neck Road South  
Mashpee, MA 02649

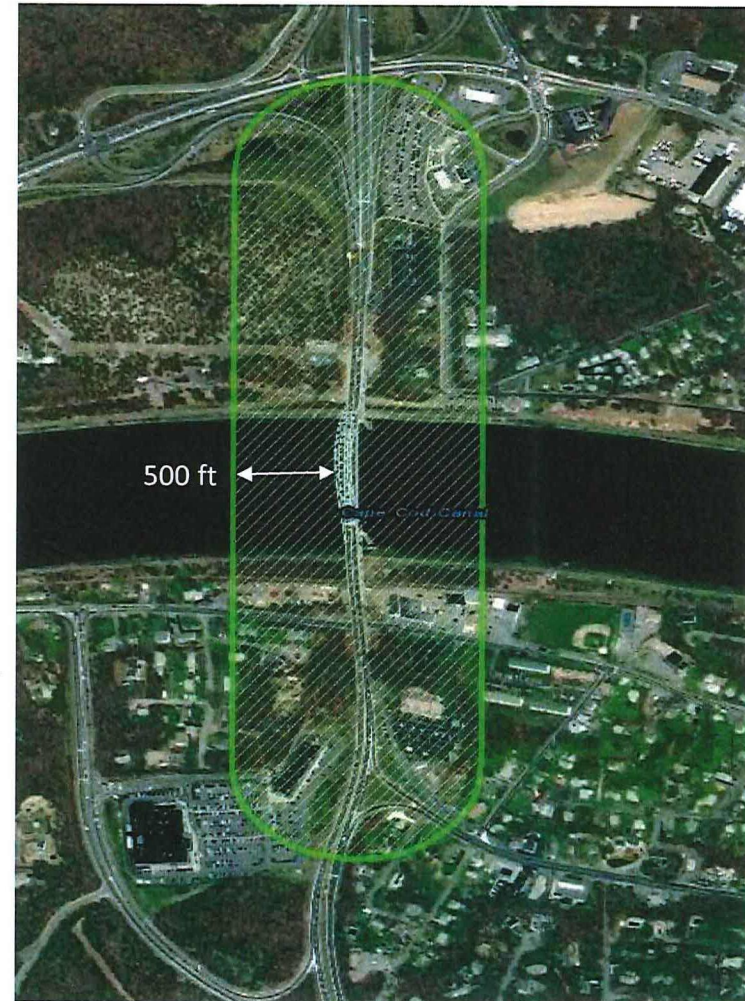
Ms. Brona Simon, State Historic Preservation Officer  
Massachusetts Historic Commission  
220 Morrissey Boulevard  
Boston, MA 02125

# Map of Existing Bridges and NEPA Survey Areas

## BOURNE BRIDGE



## SAGAMORE BRIDGE



MAJOR REHABILITATION EVALUATION STUDY Cape Cod Canal Bridges



## 7.2 Programmatic Agreement between the USACE and the MA SHPO, March 11, 2022

PROGRAMMATIC AGREEMENT BETWEEN THE  
UNITED STATES ARMY CORPS OF ENGINEERS, NEW ENGLAND DISTRICT AND  
THE MASSACHUSETTS STATE HISTORIC PRESERVATION OFFICER  
REGARDING  
THE CAPE COD CANAL HIGHWAY BRIDGES PROJECT,  
TOWNS OF BOURNE AND SANDWICH, BARNSTABLE COUNTY, MASSACHUSETTS

WHEREAS, the U.S. Army Corps of Engineers, New England District (USACE) owns, operates, and maintains the Cape Cod Canal Federal Navigation Project (CCC-FNP), including the Bourne and Sagamore Highway Bridges, under the authority of the Rivers and Harbors Acts of 1927 and 1935; and

WHEREAS, the Bourne and Sagamore Bridges, constructed in 1933-1935, have exceeded their expected lifespans and are functionally obsolete, and the Bourne Bridge has been classified as deficient under current Federal Highway Administration guidelines; and

WHEREAS, USACE has completed a Major Rehabilitation and Evaluation Report (MRER) to evaluate alternatives for the rehabilitation or replacement of the Sagamore and Bourne Bridges to determine the likely future course of action; and

WHEREAS, USACE analyzed three alternatives in the MRER including (1) continued maintenance and repair; (2) major rehabilitation of both bridges with regular maintenance and repair and another expected rehabilitation action for each bridge within the 50-year period of analysis; and (3) construction of two new bridges and approach roadways followed by demolition of the existing bridges; and

WHEREAS, the MRER determined that the replacement of both bridges would be the most prudent and cost-effective means of providing safe and reliable crossings of the Cape Cod Canal (CCC); and

WHEREAS, USACE has entered into a Memorandum of Understanding (MOU) (Attachment A) executed July 7, 2020, with the Massachusetts Department of Transportation (MassDOT) that establishes roles and responsibilities between the two agencies for the construction of the new bridges and the demolition of the existing bridges; and

WHEREAS, the MOU provides that USACE will facilitate approval for transfer of necessary Federal property interests from USACE to MassDOT for MassDOT to own, operate, and maintain the new bridges, their approaches, and necessary ancillary features; and

PROGRAMMATIC AGREEMENT AMONG THE UNITED STATES ARMY CORPS OF ENGINEERS, NEW ENGLAND DISTRICT AND THE MASSACHUSETTS STATE HISTORIC PRESERVATION OFFICER REGARDING THE CAPE COD CANAL HIGHWAY BRIDGES PROJECT

WHEREAS, USACE has determined that the proposed construction and demolition activities and the transfer of federal assets as described in the MOU are a Federal undertaking subject to consultation under Section 106 of the National Historic Preservation Act of 1966, as amended (54 U.S.C. § 306108) (Section 106), and its implementing regulations (36 CFR 800); and

WHEREAS, USACE and MassDOT are in the early stages of discussion for the Undertaking and have not determined the extent of necessary Federal property interests that will be transferred from USACE to MassDOT; the precise locations of the new canal crossings; the structural type of the proposed new bridges; methods of demolition or construction; locations of access roads, detour routes, or staging areas; the layout of the approach roadways along Route 6 and Route 28 north and south of the CCC-FNP; or any additional right of way that may be necessary for the Undertaking; and

WHEREAS, USACE has developed this Programmatic Agreement (Agreement) pursuant to 36 CFR § 800.14(b)(1)[ii], which allows Federal agencies to fulfill their Section 106 obligations through the development and implementation of such Agreements when effects on historic properties cannot be determined prior to approval of an Undertaking; and

WHEREAS, USACE has determined that the preliminary direct Area of Potential Effects (APE) on Federal property within the CCC-FNP for this Undertaking (Attachment B) includes the existing bridges and their immediate approaches, the adjacent new crossings, as well as access roads, staging areas and other elements needed for demolition and construction activities and the transfer of federal property interests; and

WHEREAS, USACE has determined that the preliminary direct APE for this Undertaking on non-federal property includes the approach roadways north and south of the CCC-FNP along U.S. Route 6 (Sagamore Bridge) and State Route 28 (Bourne Bridge) that will be realigned and reconstructed to reconnect the new bridges into the National Highway System and any necessary access roads, temporary detours, or staging areas; and

WHEREAS, USACE has determined the preliminary direct APE on both federal and non-federal property in consultation with the Massachusetts State Historic Preservation Officer (SHPO), the Tribal Historic Preservation Officers (THPOs) of the Mashpee Wampanoag Tribe and the Wampanoag Tribe of Gay Head (Aquinnah), and other consulting parties in accordance with 36 CFR 800.4(b) and SHPO and THPOs have concurred with the preliminary direct APE with the understanding that the direct APE shall be refined as design for the Undertaking progresses and that an indirect APE shall be determined; and

WHEREAS, USACE concurs with formal recommendations made by SHPO in 1991 that the Bourne and Sagamore Bridges are eligible for individual listing in the National Register of Historic Places (NRHP); and

WHEREAS, USACE has determined and the SHPO staff have agreed that the Cape Cod Canal area (MHC Inventory Form # BOU.AF/FAL.BG/SWD.Z/WRH.V) meets the criteria of eligibility for listing in the National Register of Historic Places as a historic district and that the Bourne and Sagamore Bridges meet the National Register eligibility criteria for individual listing as well as contributing elements of the Cape Cod Canal historic district; and

WHEREAS, the APE is known to be archaeologically sensitive for pre-Contact sites, unmarked human burials, and ceremonial sites and that professional archaeological assessment will be required on both Federal and non-federal land in consultation with SHPO, THPOs, and other consulting parties, as appropriate, in accordance with 36 CFR § 800.2, during the design phase of the Undertaking and, as necessary, during construction activities; and

WHEREAS, USACE, in consultation with SHPO, has determined that demolition of the Bourne and Sagamore Bridges will have adverse effects on those two NRHP-eligible structures in accordance with 36 CFR § 800.5(a); and

WHEREAS, USACE will determine effects on the NRHP-eligible CCC Historic District or other NRHP-eligible historic or archaeological properties within the preliminary direct APE or an indirect APE as yet to be determined in consultation with SHPO, THPOs, and other consulting parties as design for the Undertaking progresses; and

WHEREAS, in accordance with 36 CFR § 800.6(a)(1)(i), USACE has notified the Advisory Council on Historic Preservation (ACHP) of its intention to develop this Agreement on May 28, 2020, and the ACHP determined its involvement in consultation to resolve adverse effects was unnecessary in a letter dated June 10, 2020; and

WHEREAS, USACE has consulted with SHPO pursuant to 36 CFR § 800.3(c)(3); and

WHEREAS, in accordance with 36 CFR § 800.6(c)(2)(iii), USACE has invited MassDOT to sign this Agreement based on the responsibilities MassDOT has assumed under the MOU and MassDOT has agreed to sign as an Invited Signatory; and

WHEREAS, in accordance with 36 CFR § 800.3(c)(3), USACE has invited the Mashpee Wampanoag Tribe to sign this Agreement as a Concurring Party in a letter dated June 8, 2020 and by email on November 10, 2021, and the Mashpee Wampanoag Tribe have not yet responded; and

WHEREAS, in accordance with 36 CFR § 800.3(c)(3), USACE has invited the Wampanoag Tribe of Gay Head (Aquinnah) to sign this Agreement as a Concurring Party and the Wampanoag Tribe of Gay Head (Aquinnah) has accepted in an email dated June 10, 2020; and

WHEREAS, in accordance with 36 CFR § 800.2(c)(3), USACE has invited the Bourne Historical Commission (BHC) to sign this Agreement as a Concurring Party and the BHC, by electronic mail dated November 16, 2021, requested the preservation of certain salvageable

items from the bridges such as plaques, attachments, signs, etc. as well as historical photographs; and

WHEREAS, in accordance with 36 CFR § 800.2(c)(3), USACE has invited the Sandwich Historical Commission (SHC) to sign this Agreement as a Concurring Party and the SHC has accepted in an email dated June 26, 2020; and

WHEREAS, in accordance with 36 CFR § 800.2(c)(5), USACE has invited the Massachusetts Board of Underwater Archaeological Resources (BUAR) to sign this Agreement as a Concurring Party and the BUAR has accepted in a letter dated June 22, 2020; and

WHEREAS, in accordance with 36 CFR § 800.2(c)(5), USACE has invited the Cape Cod Commission (Commission) to sign this Agreement as a Concurring Party and the Commission has accepted in an email dated June 11, 2020; and

WHEREAS, in accordance with 36 CFR § 800.2(d), the USACE has solicited public comment on the Undertaking through a coordinated site visit with the interested agencies held on March 19, 2019, public meetings held before the publication of the draft environmental assessment (EA) on December 4, 5, 6, 11, and 12, 2018 and public meetings after publication of the draft EA held on October 16, 17, 21, 22, and 23, 2019; and

WHEREAS, the Mass DOT has held 2 separate rounds of stakeholder and public meetings on June 21, 22, 23, 29, and 30, 2021, and November 1, 3, 9, 10, 11, 16, and 18, 2021 and public comments regarding historic properties, if any, will be provided to SHPO; and

WHEREAS, for the purposes of this agreement, signatories refer to USACE, SHPO and the MassDOT; and

NOW, THEREFORE, pursuant to 54 U.S.C. § 306108 and 36 CFR Part 800, USACE and SHPO agree that the Undertaking shall be implemented in accordance with the following stipulations to satisfy USACE's Section 106 responsibilities to take into account the effects of the Cape Cod Canal Highway Bridges Project on historic properties.

## **STIPULATIONS**

USACE shall ensure that the following measures are carried out:

### **I. APPLICABILITY**

- A. At the time of the execution of this Agreement, USACE has not received a Congressional appropriation to fund the replacement of the Bourne and Sagamore Bridges. No transfer of federal property from USACE to MassDOT has occurred. This Agreement shall apply to USACE only if such Congressional appropriation is forthcoming.

- B. USACE will be involved in the design of the new bridges. If a Congressional appropriation for the undertaking is authorized for a federal agency other than USACE, then USACE, as the owner of the bridges and the CCC-FNP, shall consult and amend this Agreement as necessary with the signatories in accordance with XIV below and pursuant to 36 CFR 800.14(b)(3). MassDOT shall participate in that Agreement.
- C. Any alteration to, or temporary or permanent occupation or use of a USACE Federally authorized civil works project will require permission from USACE pursuant to 33 U.S.C. § 408 as well as any other applicable regulatory approvals.

## **II. APE, VIEWSHED, INVENTORY, AND BRIDGE DESIGN**

- A. USACE and MassDOT shall continue to consult with SHPO, THPOs, concurring parties and other consulting parties, as appropriate, as design progresses to avoid, minimize, or mitigate adverse effects to properties that are listed or eligible for listing in the NRHP.
- B. USACE and MassDOT, in consultation with the SHPO, THPOs, concurring parties and other consulting parties, shall continue to refine the direct and indirect APEs for the undertaking, including viewsheds, as the design progresses. Viewsheds shall include those from within the NRHP-eligible CCC Historic District as well as those from NRHP-eligible historic districts and historic buildings located outside of the boundaries of the CCC-FNP.
- C. USACE and MassDOT shall prepare viewshed analyses for various structural types that might be proposed for the new bridges, as well as the current bridges, to determine if historic properties both within the NRHP-eligible CCC Historic District and outside the CCC-FNP have views that might be affected by the construction of the proposed new bridges.
- D. USACE and MassDOT shall evaluate the significance of any building within the viewshed that appears to be more than 40 years old by applying the NRHP Criteria for Evaluation (36 CFR 60).
- E. USACE and MassDOT shall prepare a MHC historic inventory Form A or Form B, as appropriate, for any area or building within the viewshed of the undertaking outside of the CCC-FNP that is greater than 40 years old, if a Form A or Form B for such historic district or historic building is not already included in the Inventory of Historic Assets of the Commonwealth. All inventory forms shall be prepared according to MHC's Historic Properties Survey Manual.
- F. USACE and MassDOT shall prepare a NRHP eligibility recommendation for any previously inventoried Area or building within the viewshed of the undertaking by applying the NRHP Criteria for Evaluation and in accordance with the procedures contained in 36 CFR 60 .
- G. USACE and MassDOT, in consultation with SHPO and other consulting parties, shall assess effects of the undertaking on the NRHP-eligible CCC Historic District and on those



NRHP-eligible historic districts or historic buildings identified above in Subsections C and D.

- H. USACE and MassDOT shall make a good faith effort to design, position, and construct new bridges that will avoid adverse effects to the NRHP-eligible CCC Historic District and any NRHP-eligible properties within the viewshed of the undertaking.
- I. USACE and MassDOT shall present design alternatives for the bridges to the consulting parties and the public for comment prior to choosing a preferred alternative.

### **III. RESOLUTION OF ADVERSE EFFECTS**

- A. Mitigation for the adverse effects to the NRHP-eligible Bourne and Sagamore Bridges shall be determined in an amendment to this Agreement following the selection of a preferred alternative by USACE and MassDOT for the new bridges within the NRHP-eligible CCC Historic District. Mitigation shall be determined in consultation with SHPO, THPOs, other consulting parties, and the public, as appropriate. An example of possible at minimum, but not all inclusive, mitigation is the preservation of salvageable items from the bridges requested by the BHC above.
- B. The Amendment to this Agreement also shall address any adverse effects that the undertaking might cause to the NRHP-eligible CCC Historic District or other historic districts or historic buildings within the viewshed of the bridges that might be eligible for listing in the NRHP.
- C. No demolition or construction activities associated with the undertaking or transfer of federal assets shall occur until the Agreement is fully executed, except as specified in Stipulation IX.
- D. Adverse effects that might be caused by the undertaking to archaeological properties shall be addressed below in Stipulation IV.

### **IV. IDENTIFICATION AND EVALUATION OF ARCHEOLOGICAL RESOURCES**

#### **A. Archaeological Sensitivity Assessment**

- 1. USACE and MassDOT shall ensure that an archaeological sensitivity assessment report (report) is prepared by a qualified professional archaeological consulting firm for the direct APE including both Federal land within the CCC-FNP and non-federal land along Route 6 and Route 28 and ancillary areas. The report shall assess the potential for the presence of pre-contact archaeological sites, unmarked human burials, and ceremonial sites, as well as any potential historic or underwater archaeological resources. The report shall make recommendations for further archaeological investigations.
- 2. USACE shall ensure that copies of the draft report are submitted to SHPO, THPOs, and BUAR for review and comment. Recipients shall provide written comments to

USACE, either by hard-copy or email, within thirty (30) days of receipt of the report. Failure to respond within thirty days shall indicate concurrence with the recommendations in the report. USACE shall ensure that any comments from SHPO, THPOs, or BUAR are addressed in a timely manner prior to proceeding with further archaeological investigations.

**B. Archaeological Investigations on Federal Property**

1. Based on the report, and considering written comments from SHPO, THPOs, and BUAR, the USACE Archaeologist shall determine if further archaeological investigations are required on Federal property within the CCC-FNP. Such investigations shall be conducted by a qualified professional archaeological firm, which shall submit a permit application to USACE under the Archaeological Resources Protection Act (ARPA) of 1979 (P.L. 59-209; 34 Stat. 225; 54 U.S.C. 320301-320303; 43 CFR 3).
2. USACE shall submit any ARPA permit application to the appropriate THPOs for review and comment prior to issuing the ARPA permit, pursuant to 43 CFR 7.7(a).
3. USACE shall submit any ARPA permit application to the SHPO for review and comment prior to issuing the ARPA permit.
4. USACE shall submit any ARPA permit application to the BUAR for review and comment prior to issuing the ARPA permit if the subject of the application includes underwater archaeological investigation.
5. The SHPO, THPOs, and BUAR shall respond in writing to USACE within thirty (30) days of receipt of an ARPA permit application.
6. USACE shall ensure that the THPOs are invited to participate in any archaeological investigations within the CCC-FNP.
7. USACE shall ensure that the BUAR is invited to participate in any archaeological investigations that involve potential underwater archaeological resources within the CCC-FNP.

**C. Archaeological Investigations on Non-Federal Land**

1. MassDOT shall be responsible for archaeological assessments and investigations on non-federal land within the direct APE but outside the boundaries of the CCC-FNP, generally along Route 6 at the northerly and southerly approaches to the Sagamore Bridge and Route 28 at the northerly and southerly approaches to the Sagamore Bridge, but also including access roads, temporary detour routes, staging areas, etc.
2. As design progresses for the realignment and reconstruction of the approach roadways, the MassDOT Archaeologist shall review the report and make recommendations to SHPO and THPOs for further archaeological investigations within areas of the direct APE on non-federal land outside of the CCC-FNP.

3. Identification efforts and the scopes of archaeological surveys on non-federal land shall be developed in consultation with SHPO. Any archaeological surveys on non-federal land outside of the CCC-FNP shall be conducted under a Massachusetts State Archaeologist's permit and be consistent with the permit regulations (950 CMR 70) and the Secretary of Interior's Standards and Guidelines for Identification (48 FR 44720-23).
4. MassDOT, or its representative, shall notify the THPOs at least fourteen (14) calendar days in advance of any upcoming archaeological surveys that will be conducted outside of the CCC-FNP. THPOs shall be invited to participate in any archaeological surveys outside of the CCC-FNP.

**D. Assessment of Archaeological Properties and Resolution of Adverse Effects**

1. USACE and/or MassDOT shall assess all archaeological resources identified within the direct APE, both terrestrial and underwater, to determine the resource's eligibility for listing in the NRHP in accordance with 36 CFR 800.4(b). SHPO, THPOs, and BUAR shall be given an opportunity to review and comment on such assessments.
2. For all NRHP-eligible archaeological resources within the APE for which USACE or MassDOT have determined that the Undertaking will cause an adverse effect, USACE and MassDOT will consult further with SHPO, THPOs, and BUAR to determine if there are practicable ways to avoid or minimize the adverse effects in accordance with 36 CFR § 800.6.
3. If an adverse effect to any NRHP-eligible archaeological resource cannot be practicably avoided, and USACE, MassDOT, SHPO, THPOs, and BUAR, as appropriate, agree on how the adverse effects shall be resolved, they shall develop and implement a data recovery plan.
4. Any agreed-upon data recovery will be completed before ground-disturbing activities associated with demolition, construction or land transfer activities are initiated at or near the affected archaeological site. THPOs will be invited to participate in any data recovery. The BUAR will be invited to participate in any underwater data recovery.

**V. CURATION STANDARDS**

- A. All original archaeological records (research notes, field records, maps, drawings, and photographic records) produced as a result of implementing the Stipulations of this Agreement on federal land and all archaeological collections recovered from federal land within the APE shall be curated in accordance with 36 CFR 79, *Curation of Federally Owned and Administered Archaeological Collections*.
- B. All original archaeological records (research notes, field records, maps, drawings, and

photographic records) produced as a result of implementing the Stipulations of this Agreement on non-federal land and all archaeological collections recovered from non-federal land within the APE shall be curated in accordance with 36 CFR 79, *Curation of Federally Owned and Administered Archaeological Collections* and the *State Archaeologist's Permit Regulations (950 CMR 70)*.

## VI. PROFESSIONAL STANDARDS

### A. Research Standards

All work carried out pursuant to this Agreement shall meet or exceed the *Secretary of the Interior's Standards for Archaeology and Historic Preservation* (SOI's Standards; [http://www.nps.gov/history/local-law/arch\\_stnds\\_9.htm](http://www.nps.gov/history/local-law/arch_stnds_9.htm)).

### B. Professional Standards

All work carried out pursuant to this Agreement shall be done by or under the direct supervision of the appropriate professionals who meet or exceed the *Secretary of the Interior's Professional Qualifications Standards* (Federal Register, Vol. 62, No. 119, pp. 33708-33723) in the appropriate discipline. Consultants retained for services pursuant to this Agreement shall meet these standards.

### C. Documentation Standards

All technical reports prepared pursuant to this Agreement shall be consistent with the *Secretary of the Interior's Standards and Guidelines for Archaeological Documentation* (48 FR 44734-37), the *Secretary of the Interior's Standards for Rehabilitation*, as well as *Preservation Briefs*, and *The Historic American Buildings Survey and Historic American Engineering Record* (U.S. Department of the Interior, National Park Service), and the *ACHP's Recommended Approach for Consultation on Recovery of Significant Information from Archaeological Sites* (1999), or subsequent revisions, or any subsequent revisions or replacements of these documents.

## VII. UNMARKED HUMAN BURIALS

- A. Pursuant to 36 CFR 800.13(a)(1), in the event human skeletal remains or unmarked human burials are encountered during implementation of the Undertaking, work shall stop in the vicinity of the properties and the process in Attachments C and D will be followed. Other federal, state, and local laws, regulations, and policies as appropriate also might apply.
- B. Historic and pre-contact human remains from federal land are subject to the Native American Graves Protection and Repatriation Act.
- C. Historic and pre-contact human remains on non-federal, non-tribal lands are subject to protection under MGL Chapter 9, Section 26A and 27C.

- D. Attachment C more fully describes the process for the treatment of human remains discovered on federal land.
- E. The MassDOT Standard Special Provision 7.23 dated August 10, 2012, regarding Discovery of Unanticipated Archaeological and Skeletal Remains (Attachment D) shall be inserted into any construction contract issued by MassDOT for the Undertaking.

#### **VIII. POST-REVIEW DISCOVERIES**

- A. Pursuant to 36 CFR 800.13(a)(1), if properties are discovered that may be eligible for listing in the NRHP or unanticipated effects on historic properties found subsequent to the completion of surveys under Stipulations II and IV, work shall stop in the vicinity of the properties and the process in Attachments C and D will be followed.

The MassDOT Standard Special Provision 7.23 dated August 10, 2012, regarding Discovery of Unanticipated Archaeological and Skeletal Remains (Attachment D) shall be inserted into any construction contract issued by MassDOT for the Undertaking.

#### **IX. EARLY ACTION ITEMS**

- A. Soil borings may be necessary on both Federal and non-federal land within the APEs to provide geotechnical information that will advance the project design. Soil borings on USACE land will require USACE approval through the ARPA permit application process.
- B. Conduits for utilities (water, electricity, natural gas, telecommunications) are attached to both the Bourne and Sagamore Bridges. Removal of the conduits from the bridges and their relocation within the CCC-FNP will be necessary to demolish the existing bridges but also will have independent utility as a means to update the conduits and provide more secure subsurface locations.
- C. Soil borings and relocation of utilities may be conducted prior to the resolution of adverse effects under this Agreement provided that all provisions in Stipulations IV-VII above are followed each time that soil borings or utilities' relocations are proposed.

#### **X. REVISIONS TO THE SCOPE OF THE UNDERTAKING**

In the event of any changes to the scope of the Undertaking that may alter any of the APEs, USACE and/or MassDOT shall consult with the SHPO, THPOs, and other Consulting Parties pursuant to 36 CFR § 800.2 through § 800.5.

#### **XI. COMMUNICATION**

- A. All formal submittals to SHPO shall be on hard copy printed paper delivered by U. S. Mail, other delivery service, or by hand. Such submittals shall include Section 106 effect

findings, this Agreement, all Memoranda of Agreement, survey reports, archaeological permit applications to the State Archaeologist, copies of ARPA permit applications from USACE, archaeological site forms, inventory forms, and any other submittals as specified by SHPO, and all revisions or amendments to same.

- B. Electronic mail (email) may serve as the official correspondence method for all other communications regarding this Agreement and its provisions unless otherwise agreed to. See Attachment E for a list of contacts and email addresses. Contact information in Attachment E may be updated as needed without an amendment to this Agreement. It is the responsibility of each party to the Agreement to provide any change in name, address, email address, or phone number of any point-of-contact. This information shall be forwarded to all signatories and Concurring Parties by email or US Mail as appropriate.

## **XII. DISPUTE RESOLUTION**

Should any signatory to this Agreement object in writing at any time to any actions proposed under this Agreement, or the manner in which the terms of this Agreement are implemented, consultation with the objecting party shall be undertaken to resolve the objection. If objections cannot be resolved, then the following actions will be completed:

### **A. Documentation**

Forward all documentation relevant to the dispute, including the proposed resolution, to the ACHP. The ACHP shall provide its advice on the resolution of the objection within thirty (30) days of receiving adequate documentation. Prior to USACE reaching a final decision on the dispute, a written response that takes into account any timely advice or comments regarding the dispute from the ACHP, signatories and concurring parties will be prepared. Each party will be provided a copy of this written response.

### **B. Resolution**

If the ACHP does not provide its advice regarding the dispute within the thirty (30) day time period, USACE will make a final decision on the dispute and proceed accordingly. Prior to reaching such a final decision, a written response that takes into account any timely comments regarding the dispute from the signatories and concurring parties will be prepared. All parties will be provided a copy of such written response.

### **C. Continuity**

All other actions subject to the terms of this Agreement that are not the subject of the dispute will remain unchanged.

## **XIII. ANTI-DEFICIENCY ACT**

The stipulations of this Agreement are subject to the provisions of the Anti-Deficiency Act. A reasonable and good faith efforts shall be made to secure the necessary funds to implement this Agreement in its entirety.

**XIV. AMENDMENTS**

This Agreement may be amended when such an amendment is agreed to in writing by all signatories. The amendment shall be effective on the date a copy is signed by all signatories.

**XV. TERMINATION**

If any signatory to this Agreement determines that its terms are not or cannot be carried out, that party shall immediately consult with the other signatories to attempt to develop an amendment per Stipulation XIV, above. If within thirty (30) days (or another time period agreed to by all signatories) an amendment cannot be reached, any signatory may terminate the Agreement upon written notification to the other signatories.

Once the Agreement is terminated, and prior to work continuing on the Project, either (a) another Agreement pursuant to 36 CFR § 800.14 must be executed, or (b) the comments of the ACHP under 36 CFR § 800.7 must be requested, taken into account, and responded to. The signatories will be notified as to the course of action that will be pursued.

**XVI. DURATION**

This Agreement shall remain in effect until such time as the legal requirements identified in this Agreement, and any future amendments, are completed or until the end of the ten (10) year period beginning on the date the Agreement is signed by all signatories, whichever is earlier. Six (6) months prior to the end of such ten (10) year period, the signatories, concurring, and consulting parties will be consulted to reconsider the terms of the Agreement and amend it in accordance with Stipulation XIV above, if necessary.

**XVII. EXECUTION OF THIS AGREEMENT**

This Agreement may be executed in counterparts, with a separate signature page for each party. Each party will be provided with a copy of the fully executed Agreement.

Execution of this Agreement by USACE and the SHPO and implementation of its terms evidence that USACE has taken into account the effects of this undertaking on historic properties and afforded the ACHP an opportunity to comment.

PROGRAMMATIC AGREEMENT AMONG THE UNITED STATES ARMY CORPS OF ENGINEERS, NEW ENGLAND DISTRICT AND THE MASSACHUSETTS STATE HISTORIC PRESERVATION OFFICER REGARDING THE CAPE COD CANAL HIGHWAY BRIDGES PROJECT

**SIGNATORY:**

U.S. ARMY CORPS OF ENGINEERS, NEW ENGLAND DISTRICT

By:  Date: 11 March 2022

John A. Atilano II  
Colonel, Corps of Engineers  
District Engineer



PROGRAMMATIC AGREEMENT AMONG THE UNITED STATES ARMY CORPS OF ENGINEERS, NEW ENGLAND DISTRICT AND THE MASSACHUSETTS STATE HISTORIC PRESERVATION OFFICER REGARDING THE CAPE COD CANAL HIGHWAY BRIDGES PROJECT

**SIGNATORY:**

MASSACHUSETTS HISTORICAL COMMISSION

By: Brona Simon Date: 2/22/22  
Brona Simon, Executive Director & State Historic Preservation Officer

PROGRAMMATIC AGREEMENT AMONG THE UNITED STATES ARMY CORPS OF ENGINEERS, NEW ENGLAND DISTRICT AND THE MASSACHUSETTS STATE HISTORIC PRESERVATION OFFICER REGARDING THE CAPE COD CANAL HIGHWAY BRIDGES PROJECT

**INVITED SIGNATORY:**

MASSACHUSETTS DEPARTMENT OF TRANSPORTATION

By:  Date: 1-12-2022  
Jonathan Gulliver, Highway Administrator

PROGRAMMATIC AGREEMENT AMONG THE UNITED STATES ARMY CORPS OF ENGINEERS, NEW ENGLAND DISTRICT AND THE MASSACHUSETTS STATE HISTORIC PRESERVATION OFFICER REGARDING THE CAPE COD CANAL HIGHWAY BRIDGES PROJECT

**CONCURRING PARTY:**

MASHPEE WAMPANOAG TRIBE

By: \_\_\_\_\_ Date: \_\_\_\_\_

Brian Weeden, Chairman

PROGRAMMATIC AGREEMENT AMONG THE UNITED STATES ARMY CORPS OF ENGINEERS, NEW ENGLAND DISTRICT AND THE MASSACHUSETTS STATE HISTORIC PRESERVATION OFFICER REGARDING THE CAPE COD CANAL HIGHWAY BRIDGES PROJECT

**CONCURRING PARTY:**

WAMPANOAG TRIBE OF GAY HEAD (AQUINNAH)


By: \_\_\_\_\_ Date: \_\_\_\_\_

Cheryl Andrews-Maltais, Chairwoman

PROGRAMMATIC AGREEMENT AMONG THE UNITED STATES ARMY CORPS OF ENGINEERS, NEW ENGLAND DISTRICT AND THE MASSACHUSETTS STATE HISTORIC PRESERVATION OFFICER REGARDING THE CAPE COD CANAL HIGHWAY BRIDGES PROJECT

**CONCURRING PARTY:**

MASSACHUSETTS BOARD OF UNDERWATER ARCHAEOLOGICAL RESOURCES


By:  \_\_\_\_\_ Date: 04 MAR 2022

David S. Robinson, Director

PROGRAMMATIC AGREEMENT AMONG THE UNITED STATES ARMY CORPS OF ENGINEERS, NEW ENGLAND  
DISTRICT AND THE MASSACHUSETTS STATE HISTORIC PRESERVATION OFFICER REGARDING THE CAPE COD  
CANAL HIGHWAY BRIDGES PROJECT

**CONCURRING PARTY:**


BOURNE HISTORICAL COMMISSION

By:  Date: MARCH 17, 2022  
Carl Georgeson, Chairperson

PROGRAMMATIC AGREEMENT AMONG THE UNITED STATES ARMY CORPS OF ENGINEERS, NEW ENGLAND DISTRICT AND THE MASSACHUSETTS STATE HISTORIC PRESERVATION OFFICER REGARDING THE CAPE COD CANAL HIGHWAY BRIDGES PROJECT

**CONCURRING PARTY:**

SANDWICH HISTORICAL COMMISSION

By:  *Lisa Hassler* \_\_\_\_\_ Date: 03/11/2022  
3/11/2022 6:33:51 PM GMT  
Lisa Hassler, Chairperson

PROGRAMMATIC AGREEMENT AMONG THE UNITED STATES ARMY CORPS OF ENGINEERS, NEW ENGLAND DISTRICT AND THE MASSACHUSETTS STATE HISTORIC PRESERVATION OFFICER REGARDING THE CAPE COD CANAL HIGHWAY BRIDGES PROJECT

**CONCURRING PARTY:**

CAPE COD COMMISSION

By: Kristy Senatori Date: 3/4/22  
Kristy Senatori, Executive Director



# ATTACHMENT A

## MEMORANDUM OF UNDERSTANDING BETWEEN USACE AND MASSDOT

MEMORANDUM OF UNDERSTANDING  
BETWEEN  
UNITED STATES ARMY CORPS OF ENGINEERS  
AND  
MASSACHUSETTS DEPARTMENT OF TRANSPORTATION  
REGARDING  
THE BOURNE BRIDGE AND THE SAGAMORE BRIDGE

THIS MEMORANDUM OF UNDERSTANDING (MOU) is made as of the date of the final signature below by and among the following parties: the United States of America, acting by and through the United States Department of the Army and the United States Army Corps of Engineers (USACE); and the Commonwealth of Massachusetts, acting by and through the Massachusetts Department of Transportation (MassDOT).

RECITALS

WHEREAS, the New England District of the USACE owns, operates and maintains the Bourne Bridge in Bourne, MA and the Sagamore Bridge in Sagamore, MA (Bridges) as a part of the Cape Cod Canal Federal Navigation Project;

WHEREAS, the MassDOT is responsible for operating and maintaining the state highway system pursuant to M.G.L. c.6C, including the highways and infrastructure approaching the Bridges (Approaches);

WHEREAS, the USACE and MassDOT (Parties) are engaged in a collaborative approach to future project development concerning the Bridges and Approaches through an executed MOU dated 28-June 2018;

WHEREAS, the Parties have a mutual interest in the conveyance of the rights, titles and interests to the Bridges from the USACE to the MassDOT.

NOW, THEREFORE, for and in consideration of the mutual covenants and agreements contained herein, the Parties agree as follows:

ARTICLE I: STATEMENT OF WORK

A. The USACE will:

1. Own, operate and maintain the existing Bridges until the new bridges are placed into service..
2. Support MassDOT efforts for approval for construction of replacement Bridges over navigable waters of the U.S.
3. Support replacement Bridges having the type, size and location to reasonably meet the structural, functional and other requirements, state or federal, as established by MassDOT and the Cape Cod Canal Federal Navigation Project.
4. Facilitate Approval for demolition of the existing Bridges once no longer needed for access.
5. Facilitate approval for transfer of necessary USACE property interests to MassDOT for the new bridges and approaches as necessary.
6. Provide technical assistance and legislative drafting services in response to Congressional requests for development of legislation to revise ownership of the highway bridge crossings, including a revision of paragraph (p) of 33 CFR § 207.20.

B. The MassDOT will:

1. Own, operate and maintain the existing Approaches before, during and after the replacement of the Bridges.
2. Complete the feasibility study and alternatives analysis to reasonably meet the structural, functional and other requirements, state or federal, as established by MassDOT.
3. Once permitting is secured and the funding is secured, construct replacement bridges for the Bourne and Sagamore Bridges.
4. Support demolition of the existing Bridges once no longer needed for access.
5. Accept an interest in property in order to allow MassDOT to own, operate, and maintain the completed Bridges and Approaches as part of the systems of state highways to be maintained by MassDOT.

## ARTICLE II: NOTICES

The Parties agree to share information and documents for the purposes of developing requirements for transfer or ownership of the Bridges. In that regard, they have designated the following officials to serve as Points of Contact (POC) for requesting and receiving information pertaining to the Bridges:

For MassDOT:

Jonathan Gulliver  
Highway Administrator, MassDOT

For USACE:

Scott E. Acone  
Deputy District Engineer for Programs and  
Project Management, USACE

Communications among staff for the purposes of this MOU will be necessary and is expected to occur. However, any request for information considered to be security sensitive, shall be made in

writing by the Party's POC to the other Party's POC, and must follow USACE protocols for Security Sensitive Information (SSI). MassDOT agrees to take reasonable measures to safeguard any and all sensitive information to prevent disclosure to individuals not authorized by USACE to receive information.

#### ARTICLE III: TERM

This MOU takes effect beginning on the day after the last Party signs. This MOU will expire after the new Bridges are operational and existing Bridges are demolished, unless terminated sooner by mutual agreement in accordance with Article VIII below.

#### ARTICLE IV: FUNDING

The parties hereto will cooperate as MassDOT leads the development of a funding and finance plan to secure any and all funding required to complete replacement of the Bridges. This MOU does not bind the USACE, or any federal entity, to provide or seek funding for whatever replacement bridges are decided upon in the future.

#### ARTICLE V: EXCLUSIONS

Nothing in this MOU shall be construed to extend or affect the jurisdiction or decision-making authority of either Party to this MOU beyond that which exists under current laws and regulations. Nothing in this MOU is intended or will be construed to create any rights or remedies for any third party and no third party is intended to be a beneficiary of this MOU.

#### ARTICLE VI: TRANSFERABILITY

This MOU is not transferable except with the written consent of the Parties.

ARTICLE VII: DISPUTES

Any disputes relating to this MOU will, subject to any applicable law, Executive order, directive, or instruction, be resolved by consultation between the Parties or in accordance with DODI 4000.19.

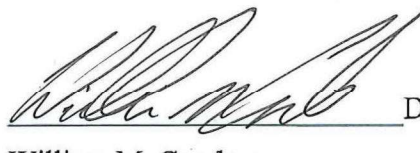
ARTICLE VIII: MODIFICATION AND TERMINATION

This MOU may only be modified by the written agreement of the Parties, duly signed by their authorized representatives. This MOU may be terminated in writing at will by either Party at any time before the date of expiration, with 30 days' notice to the other Party.

IN WITNESS WHEREOF, and intending to be bound by this MOU as a legally binding agreement, the Parties hereto have executed this MOU.

 Date 7/17/20

Stephanie Pollack  
Secretary, Department of Transportation  
Commonwealth of Massachusetts

 Date 7 July 2020

William M. Conde  
Colonel, Corps of Engineers  
District Engineer

PROGRAMMATIC AGREEMENT AMONG THE UNITED STATES ARMY CORPS OF ENGINEERS, NEW ENGLAND DISTRICT AND THE MASSACHUSETTS STATE HISTORIC PRESERVATION OFFICER REGARDING THE CAPE COD CANAL HIGHWAY BRIDGES PROJECT

## ATTACHMENT B

### PROJECT LOCATION AND PRELIMINARY AREA OF DIRECT POTENTIAL EFFECT

PROGRAMMATIC AGREEMENT AMONG THE UNITED STATES ARMY CORPS OF ENGINEERS, NEW ENGLAND DISTRICT AND THE MASSACHUSETTS STATE HISTORIC PRESERVATION OFFICER REGARDING THE CAPE COD CANAL HIGHWAY BRIDGES PROJECT

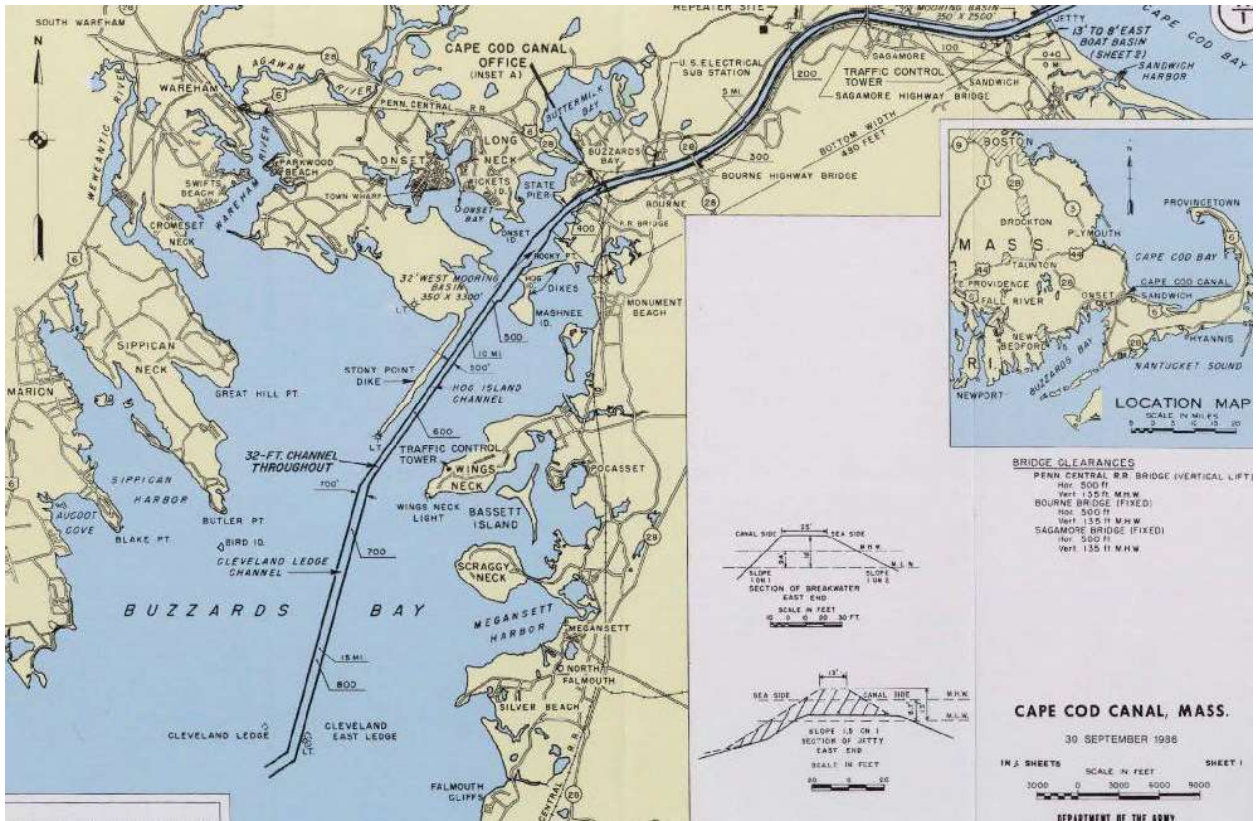
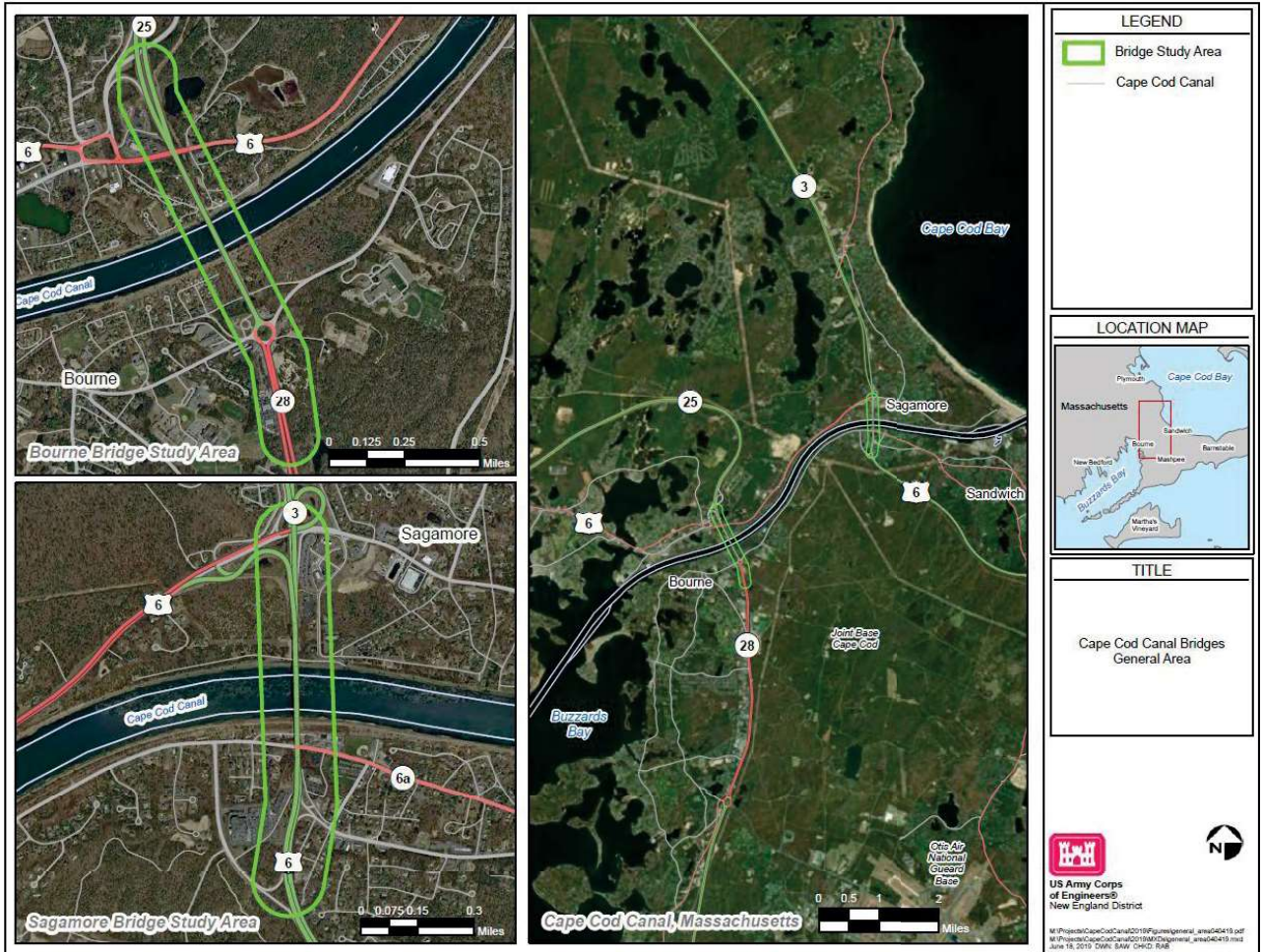


Figure 1. Cape Cod Canal Federal Navigation Project



PROGRAMMATIC AGREEMENT AMONG THE UNITED STATES ARMY CORPS OF ENGINEERS, NEW ENGLAND DISTRICT AND THE MASSACHUSETTS STATE HISTORIC PRESERVATION OFFICER REGARDING THE CAPE COD CANAL HIGHWAY BRIDGES PROJECT



**Figure 2.** Preliminary Area of Direct Potential Effect

PROGRAMMATIC AGREEMENT AMONG THE UNITED STATES ARMY CORPS OF ENGINEERS, NEW ENGLAND DISTRICT AND THE MASSACHUSETTS STATE HISTORIC PRESERVATION OFFICER REGARDING THE CAPE COD CANAL HIGHWAY BRIDGES PROJECT

# ATTACHMENT C

## PROCEDURES FOR POST REVIEW DISCOVERIES

## PROCEDURES FOR POST REVIEW DISCOVERIES

### **Post Review Discoveries**

This process shall only apply to actions in which the Corps is the lead agency for construction. The USACE will ensure that construction documents contain the following provisions for the treatment of unanticipated archaeological discoveries:

“If previously unidentified historic properties or unanticipated effects to historic properties are discovered during contract activities, the contractor shall immediately halt all activity within a one hundred (100) foot radius of the discovery, notify the USACE Project Manager and the USACE Archaeologist of the discovery and implement interim measures to protect the discovery from looting and vandalism. Work in all other areas not the subject of the discovery may continue without interruption.”

Immediately upon receipt of such notification from the construction contractor, the USACE Archaeologist shall:

1. Inspect the construction site to determine the extent of the discovery and ensure that the Undertaking in that area has halted;
2. Clearly mark the area of the discovery;
3. Implement additional measures, as appropriate, to protect the discovery from looting and vandalism;
4. Determine the extent of the discovery and provide recommendations regarding its NR eligibility and treatment; and
5. Notify the USACE Project Manager, the SHPO and other the Consulting Parties of the discovery, describing the measures that have been implemented to comply with this Stipulation.

6. Notify the Mashpee Wampanoag Tribe and the Wampanoag Tribe of Gay Head (Aquinnah) within 48 hours of the discovery.

Upon receipt of the information required in subparagraphs 1-5 above, the USACE shall provide the SHPO and the other Concurring and Consulting Parties with an assessment of the NR eligibility of the discovery and the measures proposed to resolve adverse effects. In making the evaluation, the USACE, in consultation with the SHPO, may assume the discovery to be eligible for the NR for the purposes of Section 106 pursuant to 36 CFR Part 800.13(c). The SHPO and other Consulting Parties shall respond to the USACE's assessment within forty-eight (48) hours of receipt.

The USACE shall take into account the SHPO and other Concurring and Consulting Parties' recommendations on eligibility and treatment of the discovery and shall provide the SHPO and other Consulting Parties with a report on the actions when implemented. The Undertaking may proceed in the area of the discovery, once the USACE has determined that the actions undertaken to address the discovery pursuant to this Stipulation are complete.

**Treatment of Human Remains**

The USACE shall make all reasonable efforts to avoid disturbing gravesites, including those containing Native American human remains and associated funerary objects. If human remains and/or associated funerary objects are encountered during the course of the Undertaking, the USACE shall immediately halt the Undertaking in the area and contact the USACE Archaeologist and the appropriate city Police Department.

The USACE shall treat all human remains in a manner consistent with the ACHP's Policy Statement Regarding Treatment of Burial Sites, Human Remains and Funerary Objects (February 23, 2007; <http://www.achp.gov/docs/hrpolicy0207.pdf>).

The USACE shall make a good faith effort to ensure that the general public is excluded from viewing any Native American burial site or associated funerary objects. The Consulting Parties to this PA agree to release no photographs of any Native American burial site or associated funerary objects to the press or general public. The USACE shall notify the Mashpee Wampanoag Tribe, and the Wampanoag Tribe of Gay Head (Aquinnah) when Native American burials, human skeletal remains, or funerary objects are encountered during the Undertaking. Following consultation by the USACE, the SHPO, Mashpee Wampanoag Tribe and the Wampanoag Tribe of Gay Head of Gay Head (Aquinnah), the USACE shall ensure that proper

steps are taken regarding the remains. This could include the delivery of any Native American human skeletal remains and associated funerary objects recovered pursuant to this PA to the appropriate Tribe.

If the remains are determined to be historic and not Native American, USACE shall consult with the SHPO and other appropriate Concurring and Consulting Parties prior to any excavation by providing a treatment plan including the following information:

- The name of the property or archaeological site and specific location from which the recovery is proposed. If the recovery is from a known archaeological site, a state-issued site number must be included.
- Indication of whether a waiver of public notice is requested and why. If a waiver is not requested, a copy of the public notice to be published in a newspaper having general circulation in the Cape Cod Canal area for a minimum of four weeks prior to recovery.
- A copy of the curriculum vitae of the skeletal biologist who will perform the analysis of the remains.
- A statement that the treatment of human skeletal remains and associated artifacts will be respectful.
- An expected timetable for excavation, osteological analysis, preparation of final report, and final disposition of remains.
- A statement of the goals and objectives of the removal of human remains (to include both excavation and osteological analysis).
- If a disposition other than reburial is proposed, a statement of justification for that decision.

The USACE Archaeologist shall submit the draft treatment plan to the USACE, the SHPO and appropriate Concurring and Consulting Parties for review and comment. All comments received within thirty (30) calendar days shall be addressed in the final treatment plan. Upon receipt of final approval in writing from the USACE Archaeologist, the treatment plan shall be implemented prior to those Undertaking activities that could affect the burial(s).

The USACE Archaeologist shall notify the USACE Project Manager, the SHPO, and the other Concurring and Consulting Parties in writing once the fieldwork portion of the removal of human remains is complete. The Undertaking in the area may proceed following this

PROGRAMMATIC AGREEMENT AMONG THE UNITED STATES ARMY CORPS OF ENGINEERS, NEW ENGLAND DISTRICT AND THE MASSACHUSETTS STATE HISTORIC PRESERVATION OFFICER REGARDING THE CAPE COD CANAL HIGHWAY BRIDGES PROJECT

notification while the technical report is in preparation. The USACE Archaeologist may approve implementation of undertaking-related ground disturbing activities in the area of the discovery while the technical report is in preparation.

The USACE Archaeologist shall ensure that a draft report of the results of the recovery is prepared within one (1) year of the notification that archaeological fieldwork has been completed and submitted to the USACE, the SHPO and the other Concurring and Consulting Parties for review and comment. All comments received within thirty (30) calendar days of receipt shall be addressed in the final report. When the final report has been approved by the USACE Archaeologist, two (2) copies of the document, bound and on acid-free paper and one (1) electronic copy in Adobe® Portable Document Format (.pdf) shall be provided to the SHPO; and one (1) copy in an agreed upon format to each of the other Consulting Parties.

The USACE Archaeologist shall notify the USACE Project Manager, the SHPO and other appropriate Concurring and Consulting Parties within fifteen (15) calendar days of final disposition of the human remains.

# ATTACHMENT D

## MASSDOT STANDARD SPECIAL PROVISION DISCOVERY OF UNANTICIPATED ARCHAEOLOGICAL AND SKELETAL REMAINS



# STANDARD SPECIAL PROVISIONS

(English / Metric Units)

DATE: August 10, 2012

The 1988 *Standard Specifications for Highways and Bridges*, the 1995 *Standard Specifications for Highways and Bridges (Metric)* and the *Supplemental Specifications dated June 15, 2012 (combined English and Metric)* are amended by the following modifications, additions and deletions. These are standard special provisions and they shall prevail over those published in the Standard Specifications and the Supplemental Specifications.

The Specifications Committee has issued these Standard Special Provisions for inclusion into each proposal until such time as they are approved as Standard Specifications.

Contractors are cautioned that these Standard Special Provisions are periodically updated and may vary from project to project.

## DIVISION I GENERAL REQUIREMENTS AND COVENANTS

### SECTION 7.00 LEGAL RELATIONS AND RESPONSIBILITY TO THE PUBLIC

#### **SUBSECTION 7.23 Archaeological and Paleontological Discoveries.**

*(page 38 and 38 English, page 1.47 Metric) Replace this Subsection with the following;*

#### **7.23 Discovery of Unanticipated Archaeological and Skeletal Remains.**

Should any archaeological remains be encountered during any phase of construction, the Contractor shall immediately cease all construction activities in the discovery area, secure the area and notify the Engineer. The Engineer shall immediately notify the MassDOT Environmental Services Section in Boston Headquarters Office. The MassDOT Archaeologist shall inspect the remains and their context in order to evaluate the discovery.

In the event a potentially significant archaeological find is encountered, as determined by the MassDOT Archaeologist, the Contractor shall carefully protect the discovery area by placing snow fencing and/or flagging (with an approximately 30-foot buffer zone) around the find(s). The MassDOT Archaeologist shall notify the Federal Highway Administration (if the project is federally funded), the Massachusetts State Archaeologist, the Massachusetts State Historic Preservation Officer/Executive Director of the Massachusetts Historical Commission and other parties including the Massachusetts Commission on Indian Affairs, the Tribal Historic Preservation Officers, and the Board of Underwater Archaeological Resources of the discovery and serve as the liaison on all subsequent actions. Outside the protected discovery area, construction work may continue. Construction may not resume in the discovery area until the MassDOT Archaeologist has secured all necessary regulatory approvals and given the approval to continue to the Engineer.



SUBSECTION 7.23 (continued)

If skeletal remains are discovered during construction, the Contractor shall immediately cease all work in the discovery area, secure and protect the area and notify the Engineer as stipulated above. The Engineer shall immediately contact the State Medical Examiner, the police and the MassDOT Archaeologist. If the skeletal remains prove to be human and more than 100 years old, as determined by the State Medical Examiner, the MassDOT Archaeologist shall consult with the Massachusetts State Archaeologist and other relevant parties pursuant to all procedures and protocols under the Massachusetts Unmarked Burial Law (M.G.L. Chapter 38, Section 6; M.G.L. Chapter 9, Section 26A and 27C; and M.G.L. Chapter 7, Section 38A) and Section 106 of the National Historic Preservation Act as amended, and its implementing regulations for emergency situations and post-review discoveries [36 CFR 800.12(b)(2) or 36 CFR 800.13(b)].

PROGRAMMATIC AGREEMENT AMONG THE UNITED STATES ARMY CORPS OF ENGINEERS, NEW ENGLAND DISTRICT AND THE MASSACHUSETTS STATE HISTORIC PRESERVATION OFFICER REGARDING THE CAPE COD CANAL HIGHWAY BRIDGES PROJECT

## ATTACHMENT E

### CONTACT INFORMATION

## CONTACT INFORMATION

Mr. Marcos Paiva  
Archaeologist  
New England District  
U.S. Army Corps of Engineers,  
New England District  
696 Virginia Road  
Concord, MA 01742  
Marc.A.Paiva@usace.army.mil

Ms. Bettina Washington  
Tribal Historic Preservation Officer  
Mashpee Wampanoag Tribe of Aquinnah  
20 Black Brook Road  
Aquinnah, MA 02535  
thpo@wampanoagtribe-nsn.gov

Mr. David Weeden  
Tribal Historic Preservation Officer  
Mashpee Wampanoag Tribe  
483 Great Neck Road South  
Mashpee, MA 02649  
David.Weeden@mwtribe-nsn.gov

Mr. David S. Robinson, Director  
Board of Underwater Archaeological  
Resources  
251 Causeway Street, Suite 800 Boston,  
MA 02114-2136  
David.S.Robinson@mass.gov

Ms. Kristy Senatori, Executive Director  
Cape Cod Commission  
P.O. Box 226 Barnstable, MA 02360  
ksenatori@capecodcommission.org

Ms. Brona Simon  
State Historic Preservation Officer  
Massachusetts Historical Commission  
220 Morrissey Boulevard  
Boston, MA 02125  
(617) 727-8470

Mr. Jeffrey Shrimpton  
Cultural Resources Supervisor  
MassDOT – Highway Division  
Environmental Services  
10 Park Plaza  
Boston, MA 02116  
Jeffery.Shrimpton@dot.state.ma.us

Mr. Carl Georgeson, Chairperson  
Bourne Historic Commission  
Bourne Historical Center  
30 Keene Street  
Bourne, MA 02532  
clgeorgeson@gmail.com

Ms. Lisa Hassler, Chairperson  
Sandwich Historical Commission  
P. O. Box 1905  
Sandwich, MA 02563  
lisa@historichomescapecod.com

# Attachment 8 RMAT Climate Resilience Design Standards Reports

8.1 Bourne Bridge Replacement RMAT Report

8.2 Sagamore Bridge Replacement RMAT Report

# 8.1 Bourne Bridge Replacement RMA Report

# Climate Resilience Design Standards Tool Project Report

## MassDOT Cape Cod Bridge Program - Bourne

Date Created: 10/27/2022 4:39:13 PM

Created By: lomcdonald@hntb.com

Date Report Generated: 10/28/2022 9:44:47 AM

Tool Version: Version 1.2

Project Contact Information: Lauren McDonald ([lomcdonald@hntb.com](mailto:lomcdonald@hntb.com))

## Project Summary

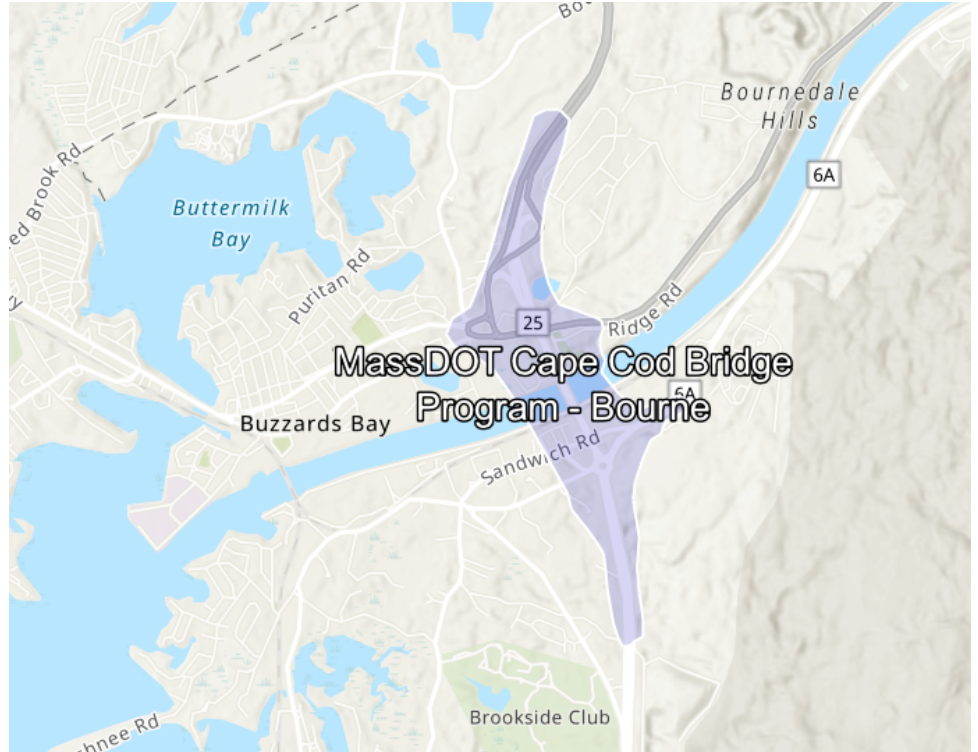
[Link to Project](#)

Estimated Capital Cost: \$3975000000.00

End of Useful Life Year: 2103

Project within mapped Environmental Justice neighborhood: No

Ecosystem Service	Scores
<b>Benefits</b>	
Project Score	Moderate
<b>Exposure</b>	
Sea Level Rise/Storm Surge	High
Surge	Exposure
Extreme Precipitation - Urban Flooding	High
Extreme Precipitation - Riverine Flooding	High
Extreme Heat	High



## Asset Preliminary Climate Risk Rating

Number of Assets: 1

### Summary

Asset Risk	Sea Level Rise/Storm Surge	Extreme Precipitation - Urban Flooding	Extreme Precipitation - Riverine Flooding	Extreme Heat
Bourne Bridge	High Risk	High Risk	High Risk	High Risk

## Climate Resilience Design Standards Summary

	Target Planning Horizon	Intermediate Planning Horizon	Percentile	Return Period	Tier
<b>Sea Level Rise/Storm Surge</b>					
Bourne Bridge	2070	2050		1000-yr (0.1%)	
<b>Extreme Precipitation</b>					
Bourne Bridge	2070			100-yr (1%)	Tier 3
<b>Extreme Heat</b>					
Bourne Bridge	2070		90th		Tier 3

## Scoring Rationale - Project Exposure Score

The purpose of the Exposure Score output is to provide a preliminary assessment of whether the overall project site and subsequent assets are exposed to impacts of natural hazard events and/or future impacts of climate change. For each climate parameter, the Tool will calculate one of the following exposure ratings: Not Exposed, Low Exposure, Moderate Exposure, or High Exposure. The rationale behind the exposure rating is provided below.

## Sea Level Rise/Storm Surge

This project received a "High Exposure" because of the following:

- Located within the predicted mean high water shoreline by 2030
- Exposed to the 1% annual coastal flood event as early as 2030
- Located within the 0.1% annual coastal flood event within the project's useful life

## Extreme Precipitation - Urban Flooding

This project received a "High Exposure" because of the following:

- Historic flooding at the project site
- Increased impervious area
- Maximum annual daily rainfall exceeds 10 inches within the overall project's useful life
- Existing impervious area of the project site is between 10% and 50%

## Extreme Precipitation - Riverine Flooding

This project received a "High Exposure" because of the following:

- Project site has a history of riverine flooding
- Part of the project is within a mapped FEMA floodplain, outside of the Massachusetts Coast Flood Risk Model (MC-FRM)
- Part of the project is within 100ft of a waterbody
- Project is potentially susceptible to riverine erosion

## Extreme Heat

This project received a "High Exposure" because of the following:

- Increased impervious area
- Existing trees are being removed as part of the proposed project
- Existing impervious area of the project site is between 10% and 50%
- 10 to 30 day increase in days over 90 deg. F within project's useful life
- Located within 100 ft of existing water body

## Scoring Rationale - Asset Preliminary Climate Risk Rating

A Preliminary Climate Risk Rating is determined for each infrastructure and building asset by considering the overall project Exposure Score and responses to Step 4 questions provided by the user in the Tool. Natural Resource assets do not receive a risk rating. The following factors are what influenced the risk ratings for each asset.

### Asset - Bourne Bridge

Primary asset criticality factors influencing risk ratings for this asset:

- Asset must be operable at all times, even during natural hazard event
- Loss/inoperability of the asset would have state-wide or greater impacts
- The infrastructure provides services to populations that reside within Environmental Justice neighborhoods or climate vulnerable populations.
- Infrastructure functions as an evacuation route during emergencies
- Cost to replace is greater than \$100 million
- There are no hazardous materials in the asset

## Project Climate Resilience Design Standards Output

Climate Resilience Design Standards and Guidance are recommended for each asset and climate parameter. The Design Standards for each climate parameter include the following: recommended planning horizon (target and/or intermediate), recommended return period (Sea Level Rise/Storm Surge and Precipitation) or percentile (Heat), and a list of applicable design criteria that are likely to be affected by climate change. Some design criteria have numerical values associated with the recommended return period and planning horizon, while others have tiered methodologies with step-by-step instructions on how to estimate design values given the other recommended design standards.

Asset: Bourne Bridge

Infrastructure

### Sea Level Rise/Storm Surge

High Risk

Target Planning Horizon: 2070

Intermediate Planning Horizon: 2050

Return Period: 1000-yr (0.1%)

**LIMITATIONS:** The recommended Climate Resilience Design Standards for the Sea Level Rise / Storm Surge Design Criteria are based on the user drawn polygon and relationships as defined in the Supporting Documents. The projected values provided through the Tool are based on the Massachusetts Coast Flood Risk Model (MC-FRM) outputs as of 9/13/2021, which included GIS-based data for three planning horizons (2030, 2050, 2070) and six return periods (0.1%, 0.2%, 0.5%, 1%, 2%, 5%). These values are projections based on assumptions as defined in the model and the LiDAR used at the time. For additional information on the MC-FRM, review the additional resources provided on the Start Here page.

The projected values, Standards, and Guidance provided within this Tool may be used to inform plans and designs, but they do not provide guarantees for future conditions or resilience. The projected values are not to be considered final or appropriate for construction documents without supporting engineering analyses. The guidance provided within this Tool is intended to be general and users are encouraged to do their own due diligence.

### Applicable Design Criteria

**Projected Tidal Datums:** APPLICABLE

**This project is located in an area with uncertainty for future tidal datums. These uncertain zones are either dynamic in terms of geomorphology or are restricted by manmade features (i.e., culverts, tide gates, etc.) that should be evaluated in more detail at the site-scale.**

**Projected Water Surface Elevation:** APPLICABLE

Asset Name	Recommended Planning Horizon	Recommended Return Period	Max	Min	Area Weighted Average
			(ft - NAVD88)		
Bourne Bridge	2050	0.1% (1000-Year)	18.8	17.7	18.2
	2070		21.1	20.3	20.7

**Projected Wave Action Water Elevation:** APPLICABLE

Asset Name	Recommended Planning Horizon	Recommended Return Period	Max	Min	Area Weighted Average
			(ft - NAVD88)		
Bourne Bridge	2050	0.1% (1000-Year)	23.7	17.7	20.1
	2070		26.5	20.3	22.8

**Projected Wave Heights:** APPLICABLE

Asset Name	Recommended Planning Horizon	Recommended Return Period	Max	Min	Area Weighted Average
			(Feet)		
Bourne Bridge	2050	0.1% (1000-Year)	8.5	0.0	3.9
	2070		8.5	0.0	4.1

**ATTENTION:** This project intersects areas that are low probability flooding zones with minimal flood risk and small depth of flooding. These areas are where flooding is expected during the most extreme storm events (> 1000-yr return period) or where there is only minor water depth during the 1000-yr return period. Additional site analyses are recommended to establish design values associated with design criteria.

**Projected Duration of Flooding:** APPLICABLE

[Methodology to Estimate Projected Values](#)

**Projected Design Flood Velocity:** APPLICABLE



**Projected Scour & Erosion:** APPLICABLE  
[Methodology to Estimate Projected Values](#)

**Extreme Precipitation**

High Risk

Target Planning Horizon: 2070  
Return Period: 100-yr (1%)

**LIMITATIONS:** The recommended Standards for Total Precipitation Depth & Peak Intensity are determined by the user drawn polygon and relationships as defined in the Supporting Documents. The projected Total Precipitation Depth values provided through the Tool are based on the climate projections developed by Cornell University as part of EEA's Massachusetts Climate and Hydrologic Risk Project, GIS-based data as of 10/15/21. For additional information on the methodology of these precipitation outputs, see Supporting Documents.

While Total Precipitation Depth & Peak Intensity for 24-hour Design Storms are useful to inform planning and design, it is recommended to also consider additional longer- and shorter-duration precipitation events and intensities in accordance with best practices. Longer-duration, lower-intensity storms allow time for infiltration and reduce the load on infrastructure over the duration of the storm. Shorter-duration, higher-intensity storms often have higher runoff volumes because the water does not have enough time to infiltrate infrastructure systems (e.g., catch basins) and may overflow or back up during such storms, resulting in flooding. In the Northeast, short-duration high intensity rain events are becoming more frequent, and there is often little early warning for these events, making it difficult to plan operationally. While the Tool does not provide recommended design standards for these scenarios, users should still consider both short- and long-duration precipitation events and how they may impact the asset.

The projected values, standards, and guidance provided within this Tool may be used to inform plans and designs, but they do not provide guarantees for future conditions or resilience. The projected values are not to be considered final or appropriate for construction documents without supporting engineering analyses. The guidance provided within this Tool is intended to be general and users are encouraged to do their own due diligence

**Applicable Design Criteria**

**Tiered Methodology:** Tier 3

**Projected Total Precipitation Depth & Peak Intensity for 24-hr Design Storms:** APPLICABLE

Asset Name	Recommended Planning Horizon	Recommended Return Period (Design Storm)	Projected 24-hr Total Precipitation Depth (inches)	Step-by-Step Methodology for Peak Intensity
Bourne Bridge	2070	100-Year (1%)	9.8	<a href="#">Downloadable Methodology PDF</a>

**Projected Riverine Peak Discharge & Peak Flood Elevation:** APPLICABLE  
[Methodology to Estimate Projected Values](#) : Tier 3

**Extreme Heat**

High Risk

Target Planning Horizon: 2070  
Percentile: 90th Percentile

**Applicable Design Criteria**

**Tiered Methodology:** Tier 3

**Projected Annual/Summer/Winter Average Temperatures:** APPLICABLE  
[Methodology to Estimate Projected Values](#) : Tier 3

**Projected Heat Index:** APPLICABLE  
[Methodology to Estimate Projected Values](#) : Tier 3

**Projected Growing Degree Days:** NOT APPLICABLE

**Projected Days Per Year With Max Temp > 95°F, >90°F, <32°F:** APPLICABLE  
[Methodology to Estimate Projected Values](#) : Tier 3

**Projected Number of Heat Waves Per Year & Average Heat Wave Duration:** APPLICABLE  
[Methodology to Estimate Projected Values](#) : Tier 3

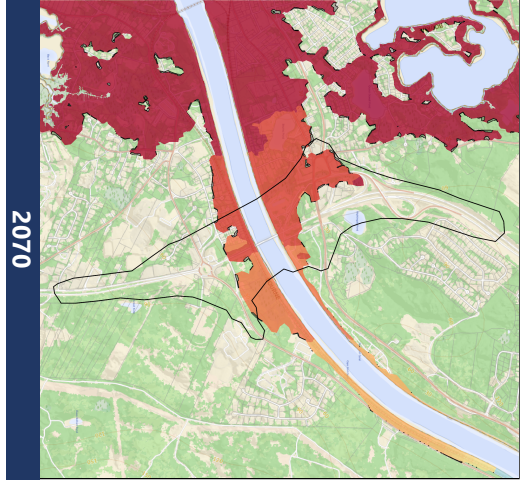
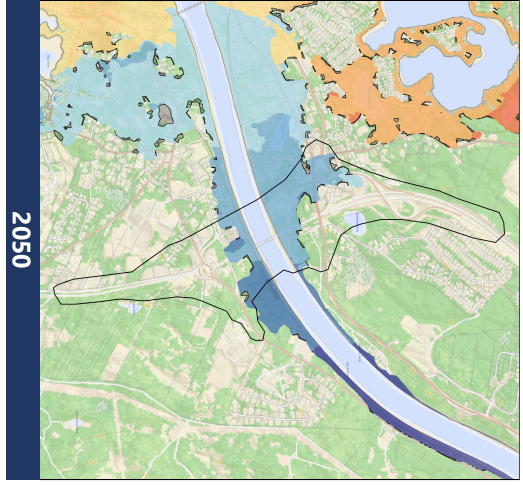
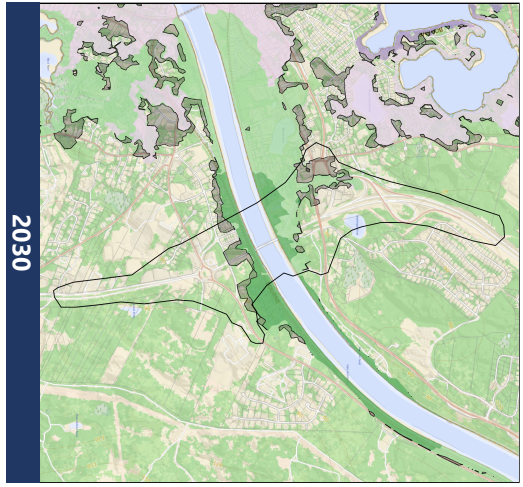
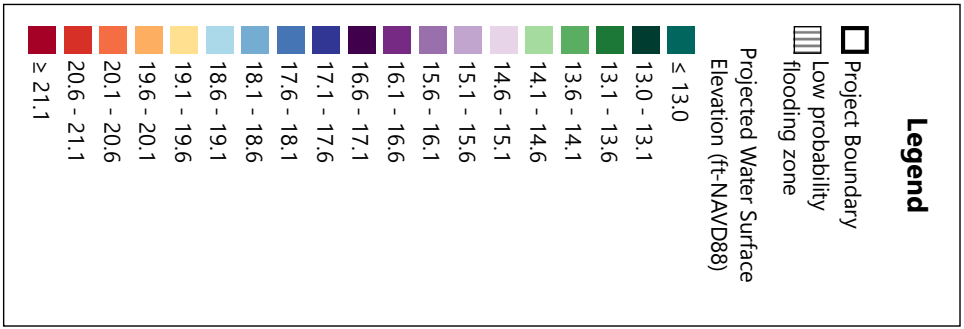
**Projected Cooling Degree Days & Heating Degree Days (base = 65°F):** NOT APPLICABLE

## Sea Level Rise/Storm Surge Project Maps

The following three maps illustrate the Projected Water Surface Elevation for the 2030, 2050, and 2070 planning horizons corresponding to the lowest return period (largest design storm) recommended across the assets identified for this project in the Tool. For projects that only have Natural Resource assets, the maps will show the Projected Water Surface Elevations corresponding to the 5% (20-year) return period. Refer to the Climate Resilience Design Standards Output - Sea Level Rise/Storm Surge Section for additional values associated with other assets. The maps include the project area as drawn by the user with a 0.1 mile minimum buffer, but do not reflect the location of specific assets on the site.

**LIMITATIONS:** The recommended Climate Resilience Design Standards for the Sea Level Rise / Storm Surge Design Criteria are based on the user drawn polygon and relationships as defined in the Supporting Documents. The projected values and maps provided through the Tool are based on the Massachusetts Coast Flood Risk Model (MC-FRM) outputs as of 9/13/2021, which included GIS-based data for three planning horizons (2030, 2050, 2070) and six return periods (0.1%, 0.2%, 0.5%, 1%, 2%, 5%). These values are projections based on assumptions as defined in the model and the LiDAR used at the time. For additional information on the MC-FRM, review the additional resources provided on the Start Here page.

The projected values, maps, Standards, and Guidance provided within this Tool may be used to inform plans and designs, but they do not provide guarantees for future conditions or resilience. The projected values are not to be considered final or appropriate for construction documents without supporting engineering analyses. The guidance provided within this Tool is intended to be general and users are encouraged to do their own due diligence.



**Climate Resilience Design Standards Tool:  
Sea Level Rise/Storm Surge Design Criteria  
Projected Water Surface Elevation Map: 0.1% (1000-yr)**

Project Name: MassDOT Cape Cod Bridge  
 Program - Bourne  
 Location (Town): Bourne

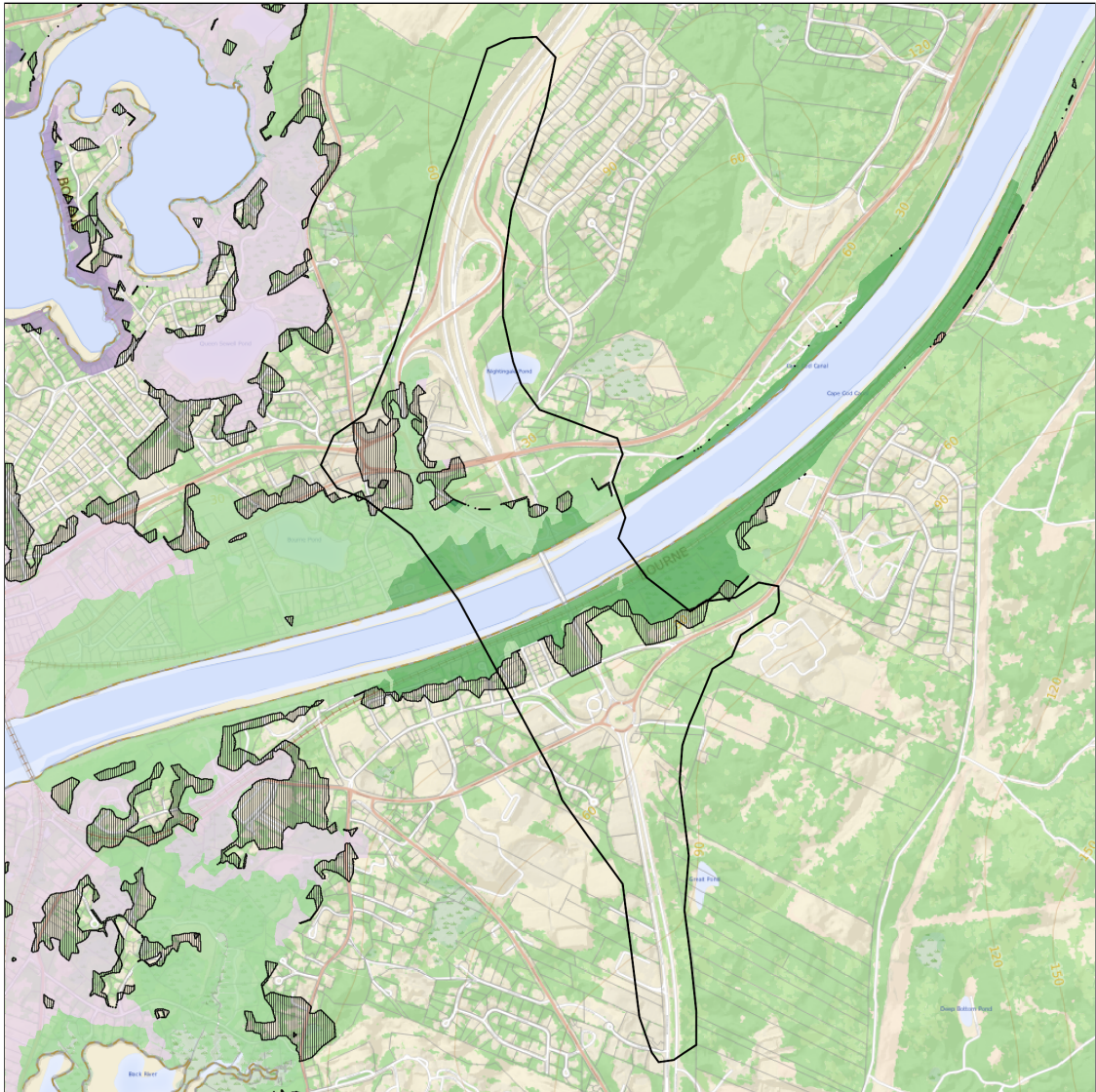
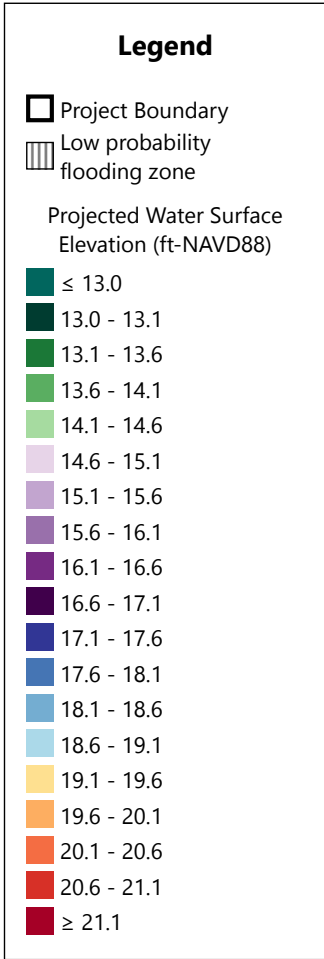


Created by: lomcdonald@hntb.com  
 Date Created: 10/27/2022  
 Tool Version: 1.2



Asset Name	Planning Horizon	Return Period	Max Min		Area Weighted Average (ft-NAVD88)
Bourne Bridge	2030	0.1% (1000-yr)	14.7	13.0	14.1
	2050	0.1% (1000-yr)	18.8	17.7	18.2
	2070	0.1% (1000-yr)	21.1	20.3	20.7

**ATTENTION: This project intersects areas that are low probability flooding zones with minimal flood risk and small depth of flooding. These areas are where flooding is expected during the most extreme storm events (> 1000-yr return period) or where there is only minor water depth during the 1000-yr return period. Additional site analyses are recommended to establish design values associated with design criteria.**



**Climate Resilience Design Standards Tool:  
Sea Level Rise/Storm Surge Design Criteria  
Projected Water Surface Elevation Map: 2030, 0.1% (1000-yr)**

Project Name: MassDOT Cape Cod Bridge  
 Program - Bourne  
 Location (Town): Bourne

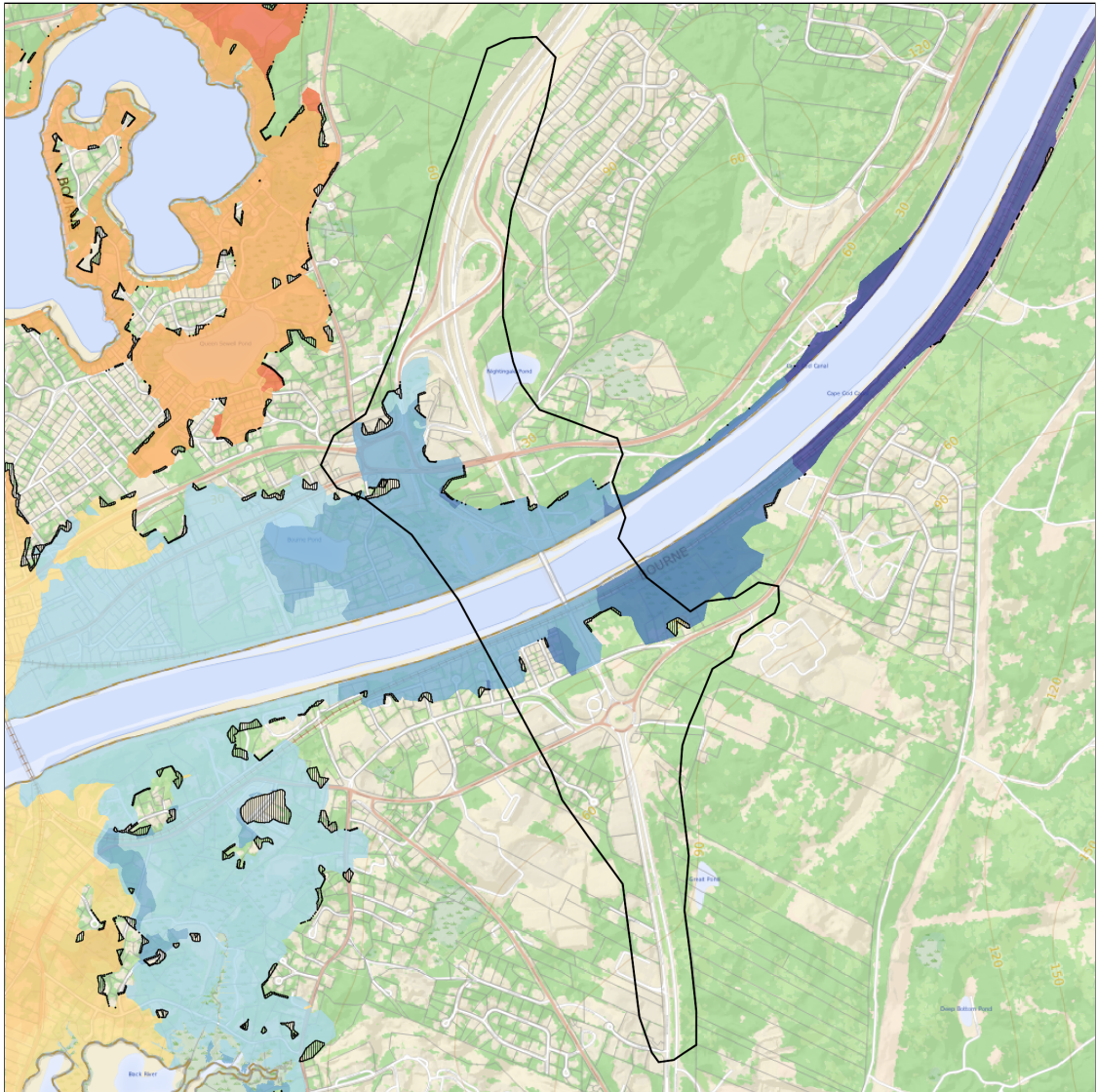
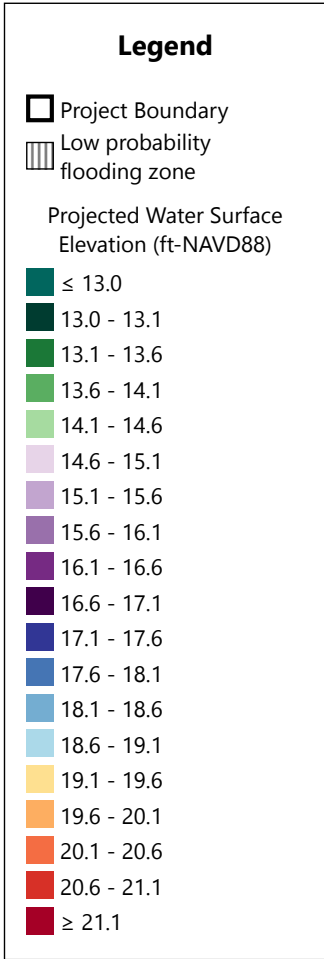


Created by: lomcdonald@hntb.com  
 Date Created: 10/27/2022  
 Tool Version: 1.2



Asset Name	Planning Horizon	Return Period	Area Weighted Average (ft-NAVD88)		
			Max	Min	Area Weighted Average
Bourne Bridge	2030	0.1% (1000-yr)	14.7	13.0	14.1

**ATTENTION: This project intersects areas that are low probability flooding zones with minimal flood risk and small depth of flooding. These areas are where flooding is expected during the most extreme storm events (> 1000-yr return period) or where there is only minor water depth during the 1000-yr return period. Additional site analyses are recommended to establish design values associated with design criteria.**



**Climate Resilience Design Standards Tool:  
Sea Level Rise/Storm Surge Design Criteria  
Projected Water Surface Elevation Map: 2050, 0.1% (1000-yr)**

Project Name: MassDOT Cape Cod Bridge  
 Program - Bourne  
 Location (Town): Bourne

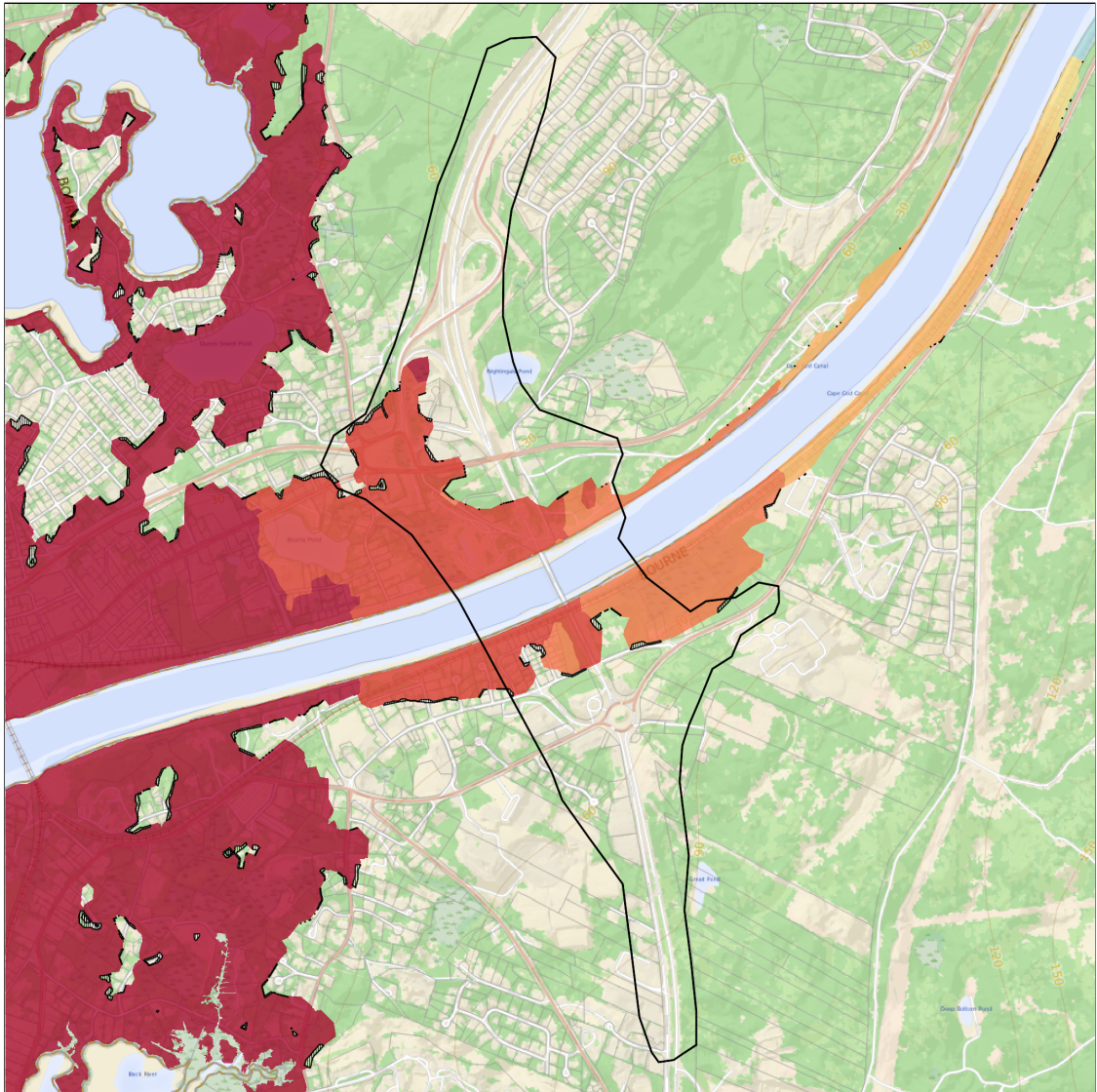
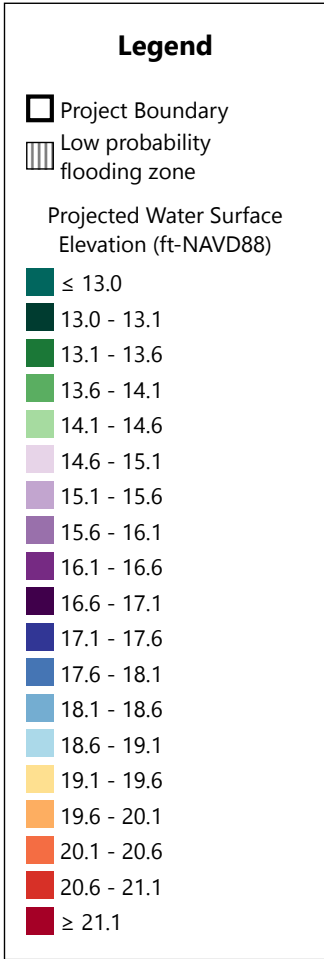


Created by: lomcdonald@hntb.com  
 Date Created: 10/27/2022  
 Tool Version: 1.2



Asset Name	Planning Horizon	Return Period	Area Weighted Average (ft-NAVD88)		
			Max	Min	Area Weighted Average
Bourne Bridge	2050	0.1% (1000-yr)	18.8	17.7	18.2

**ATTENTION: This project intersects areas that are low probability flooding zones with minimal flood risk and small depth of flooding. These areas are where flooding is expected during the most extreme storm events (> 1000-yr return period) or where there is only minor water depth during the 1000-yr return period. Additional site analyses are recommended to establish design values associated with design criteria.**



**Climate Resilience Design Standards Tool:  
Sea Level Rise/Storm Surge Design Criteria  
Projected Water Surface Elevation Map: 2070, 0.1% (1000-yr)**

Project Name: MassDOT Cape Cod Bridge  
 Program - Bourne  
 Location (Town): Bourne



Created by: lomcdonald@hntb.com  
 Date Created: 10/27/2022  
 Tool Version: 1.2



Asset Name	Planning Horizon	Return Period	Area Weighted Average (ft-NAVD88)		
			Max	Min	Area Weighted Average
Bourne Bridge	2070	0.1% (1000-yr)	21.1	20.3	20.7

**ATTENTION: This project intersects areas that are low probability flooding zones with minimal flood risk and small depth of flooding. These areas are where flooding is expected during the most extreme storm events (>1000-yr return period) or where there is only minor water depth during the 1000-yr return period. Additional site analyses are recommended to establish design values associated with design criteria.**

## Project Inputs

### Core Project Information

Name:	MassDOT Cape Cod Bridge Program - Bourne
Given the expected useful life of the project, through what year do you estimate the project to last (i.e. before a major reconstruction/renovation)?	2103
Location of Project:	Bourne
Estimated Capital Cost:	\$3,975,000,000
Who is the Submitting Entity?	State Agency Massachusetts Department of Transportation Lauren McDonald (lomcdonald@hntb.com)
Is this project identified as an agency priority project, such as in the State Hazard Mitigation and Climate Adaptation Plan (SHMCAP)?	No
Is this project being submitted as part of a state grant application?	No
Which grant program?	
What stage are you in your project lifecycle?	Pre-Planning
Is climate resiliency a core objective of this project?	Yes
Is this project being submitted as part of the state capital planning process?	No
Is this project being submitted as part of a regulatory review process or permitting?	Yes
Brief Project Description:	The preliminary purpose of the Cape Cod Bridges Program (CCBP) is to improve cross-canal mobility and accessibility between Cape Cod and mainland MA for all road users and to address the increasing maintenance needs and functional obsolescence of the aging Cape Cod Canal highway bridges. The program will improve traffic operations and multimodal accommodations to facilitate the dependable and efficient movement of people, goods, and services across the Cape Cod Canal. MassDOT has identified program goals, which include improving traffic operations and safety within the Cape Cod Canal area roadway system, improving/expanding options for non-motorists, avoiding/minimizing/mitigating impacts to adjacent residences, businesses, natural resources, open space, historic/archaeological resources, and ensuring climate resilient infrastructure design. It is anticipated that the project will require the acquisition of permits and approvals consistent with the following regulations: Section 106 of the National Historic Preservation Act, Section 4(f) of the U.S. DOT Act, MA Environmental Policy Act, National Environmental Policy Act, Coastal Zone Management Act, MA Wetlands Protection Act; Section 404 and 401 of the Clean Water Act, Section 14 of the Rivers and Harbors Act, Section 9 of the Rivers and Harbors Appropriations Act, MA Public Waterfront Act, MA Endangered Species Act, and Article 97 of the MA Constitution.

Project Submission Comments:

### Project Ecosystem Service Benefits

#### Factors Influencing Output

- ✓ Project protects public water supply
- ✓ Project recharges groundwater
- ✓ Project filters stormwater using green infrastructure
- ✓ Project improves water quality
- ✓ Project provides recreation
- ✓ Project provides cultural resources/education

#### Factors to Improve Output

- ✓ Incorporate nature-based solutions that may provide flood protection

#### Is the primary purpose of this project ecological restoration?

No

#### Project Benefits

Provides flood protection through nature-based solutions	Maybe
Reduces storm damage	No
Recharges groundwater	Yes
Protects public water supply	Yes

Filters stormwater using green infrastructure	Yes
Improves water quality	Yes
Promotes decarbonization	No
Enables carbon sequestration	No
Provides oxygen production	No
Improves air quality	No
Prevents pollution	No
Remediates existing sources of pollution	No
Protects fisheries, wildlife, and plant habitat	No
Protects land containing shellfish	No
Provides pollinator habitat	No
Provides recreation	Yes
Provides cultural resources/education	Yes

### Project Climate Exposure

Is the primary purpose of this project ecological restoration?	No
Does the project site have a history of coastal flooding?	No
Does the project site have a history of flooding during extreme precipitation events (unrelated to water/sewer damages)?	Yes
Does the project site have a history of riverine flooding?	Yes
Does the project result in a net increase in impervious area of the site?	Yes
Are existing trees being removed as part of the proposed project?	Yes

### Project Assets

Asset: Bourne Bridge  
 Asset Type: Transportation  
 Asset Sub-Type: Bridge  
 Construction Type: New Construction  
 Construction Year: 2028  
 Useful Life: 75

**Identify the length of time the asset can be inaccessible/inoperable without significant consequences.**

Infrastructure must be accessible/operable at all times, even during natural hazard event.

**Identify the geographic area directly affected by permanent loss or significant inoperability of the infrastructure.**

State-wide or greater impacts

**Identify the population directly served that would be affected by the permanent loss or significant inoperability of the infrastructure.**

Greater than 100,000 people

**Identify if the infrastructure provides services to populations that reside within Environmental Justice neighborhoods or climate vulnerable populations.**

The infrastructure provides services to populations that reside within Environmental Justice neighborhoods or climate vulnerable populations.

**Will the infrastructure reduce the risk of flooding?**

Yes

**If the infrastructure became inoperable for longer than acceptable in Question 1, how, if at all, would it be expected to impact people's health and safety?**

Inoperability of the infrastructure would result in moderate or severe injuries or moderate or severe impacts to chronic illnesses

**If there are hazardous materials in your infrastructure, what are the extents of impacts related to spills/releases of these materials?**

There are no hazardous materials in the infrastructure

**If the infrastructure became inoperable for longer than acceptable in Question 1, what are the impacts on other facilities, assets, and/or infrastructure?**

Debilitating – Inoperability will result in cascading impacts that will render other assets inoperable and/or prevent the functionality of major regional or statewide infrastructure or delivery of critical services

**If the infrastructure was damaged beyond repair, how much would it approximately cost to replace?**

Greater than or equal to \$100 million

**Does the infrastructure function as an evacuation route during emergencies? This question only applies to roadway projects.**

Yes

**If the infrastructure became inoperable for longer than acceptable in Question 1, what are the environmental impacts related to natural resources?**

No impact on surrounding natural resources is expected

**If the infrastructure became inoperable for longer than acceptable in Question 1, what are the impacts to government services (i.e. the infrastructure is not able to serve or operate its intended users or function)?**

Loss of infrastructure may reduce the ability to maintain some government services, while a majority of services will still exist

**What are the impacts to loss of confidence in government resulting from loss of infrastructure functionality (i.e. the infrastructure asset is not able to serve or operate its intended users or function)?**

Loss of confidence in Commonwealth



## Report Comments

N/A

## 8.2 Sagamore Bridge Replacement RMA Report

# Climate Resilience Design Standards Tool Project Report

## MassDOT Cape Cod Bridge Program- Sagamore

Date Created: 10/26/2022 10:25:26 AM

Created By: lomcdonald@hntb.com

Date Report Generated: 10/28/2022 9:40:39 AM

Tool Version: Version 1.2

Project Contact Information: Lauren McDonald ([lomcdonald@hntb.com](mailto:lomcdonald@hntb.com))

## Project Summary

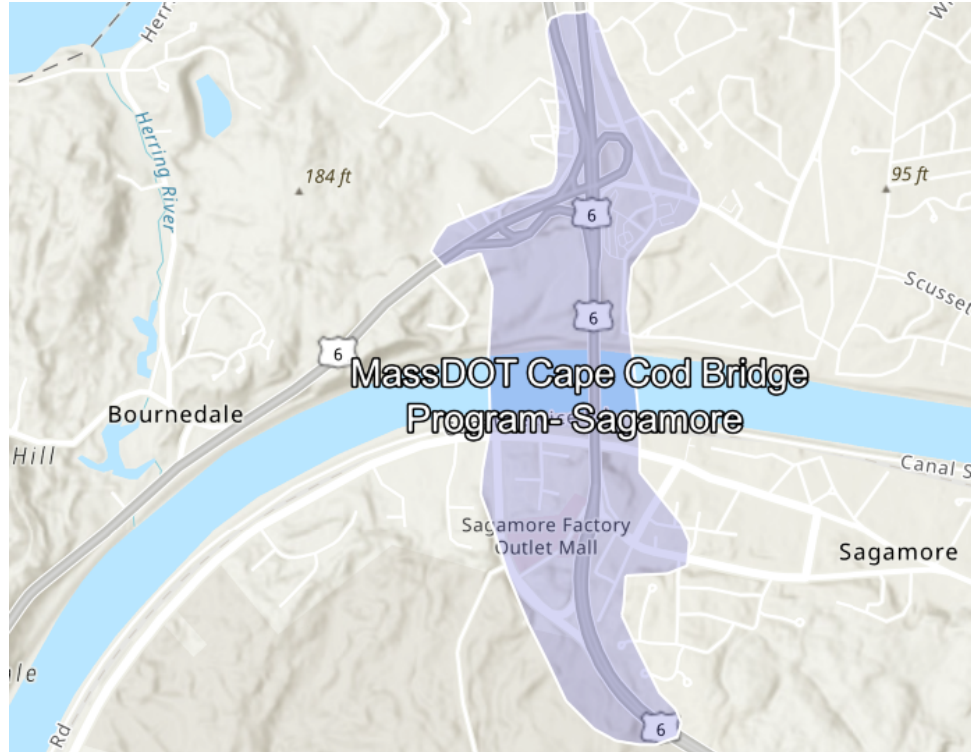
[Link to Project](#)

Estimated Capital Cost: \$3975000000.00

End of Useful Life Year: 2103

Project within mapped Environmental Justice neighborhood: Yes

Ecosystem Service	Scores
<b>Benefits</b>	
Project Score	Moderate
<b>Exposure</b>	
Sea Level Rise/Storm Surge	High
Urban Flooding	High
Extreme Precipitation - Riverine Flooding	High
Extreme Heat	High



## Asset Preliminary Climate Risk Rating

Number of Assets: 1

### Summary

Asset Risk	Sea Level Rise/Storm Surge	Extreme Precipitation - Urban Flooding	Extreme Precipitation - Riverine Flooding	Extreme Heat
Sagamore Bridge	High Risk	High Risk	High Risk	High Risk

## Climate Resilience Design Standards Summary

	Target Planning Horizon	Intermediate Planning Horizon	Percentile	Return Period	Tier
<b>Sea Level Rise/Storm Surge</b>					
Sagamore Bridge	2070	2050		1000-yr (0.1%)	
<b>Extreme Precipitation</b>					
Sagamore Bridge	2070			100-yr (1%)	Tier 3
<b>Extreme Heat</b>					
Sagamore Bridge	2070		90th		Tier 3

## Scoring Rationale - Project Exposure Score

The purpose of the Exposure Score output is to provide a preliminary assessment of whether the overall project site and subsequent assets are exposed to impacts of natural hazard events and/or future impacts of climate change. For each climate parameter, the Tool will calculate one of the following exposure ratings: Not Exposed, Low Exposure, Moderate Exposure, or High Exposure. The rationale behind the exposure rating is provided below.

## Sea Level Rise/Storm Surge

This project received a "High Exposure" because of the following:

- Located within the predicted mean high water shoreline by 2030
- Exposed to the 1% annual coastal flood event as early as 2030
- Located within the 0.1% annual coastal flood event within the project's useful life

## Extreme Precipitation - Urban Flooding

This project received a "High Exposure" because of the following:

- Historic flooding at the project site
- Increased impervious area
- Maximum annual daily rainfall exceeds 10 inches within the overall project's useful life
- Existing impervious area of the project site is between 10% and 50%

## Extreme Precipitation - Riverine Flooding

This project received a "High Exposure" because of the following:

- Project site has a history of riverine flooding
- Part of the project is within a mapped FEMA floodplain, outside of the Massachusetts Coast Flood Risk Model (MC-FRM)
- Part of the project is within 500ft of a waterbody and less than 20ft above the waterbody
- Project is potentially susceptible to riverine erosion

## Extreme Heat

This project received a "High Exposure" because of the following:

- Increased impervious area
- Existing trees are being removed as part of the proposed project
- Existing impervious area of the project site is between 10% and 50%
- 10 to 30 day increase in days over 90 deg. F within project's useful life
- Located within 100 ft of existing water body

## Scoring Rationale - Asset Preliminary Climate Risk Rating

A Preliminary Climate Risk Rating is determined for each infrastructure and building asset by considering the overall project Exposure Score and responses to Step 4 questions provided by the user in the Tool. Natural Resource assets do not receive a risk rating. The following factors are what influenced the risk ratings for each asset.

### Asset - Sagamore Bridge

Primary asset criticality factors influencing risk ratings for this asset:

- Asset must be operable at all times, even during natural hazard event
- Loss/inoperability of the asset would have state-wide or greater impacts
- The infrastructure provides services to populations that reside within Environmental Justice neighborhoods or climate vulnerable populations.
- Infrastructure functions as an evacuation route during emergencies
- Cost to replace is greater than \$100 million
- There are no hazardous materials in the asset

## Project Climate Resilience Design Standards Output

Climate Resilience Design Standards and Guidance are recommended for each asset and climate parameter. The Design Standards for each climate parameter include the following: recommended planning horizon (target and/or intermediate), recommended return period (Sea Level Rise/Storm Surge and Precipitation) or percentile (Heat), and a list of applicable design criteria that are likely to be affected by climate change. Some design criteria have numerical values associated with the recommended return period and planning horizon, while others have tiered methodologies with step-by-step instructions on how to estimate design values given the other recommended design standards.

Asset: Sagamore Bridge

Infrastructure

### Sea Level Rise/Storm Surge

High Risk

Target Planning Horizon: 2070

Intermediate Planning Horizon: 2050

Return Period: 1000-yr (0.1%)

**LIMITATIONS:** The recommended Climate Resilience Design Standards for the Sea Level Rise / Storm Surge Design Criteria are based on the user drawn polygon and relationships as defined in the Supporting Documents. The projected values provided through the Tool are based on the Massachusetts Coast Flood Risk Model (MC-FRM) outputs as of 9/13/2021, which included GIS-based data for three planning horizons (2030, 2050, 2070) and six return periods (0.1%, 0.2%, 0.5%, 1%, 2%, 5%). These values are projections based on assumptions as defined in the model and the LiDAR used at the time. For additional information on the MC-FRM, review the additional resources provided on the Start Here page.

The projected values, Standards, and Guidance provided within this Tool may be used to inform plans and designs, but they do not provide guarantees for future conditions or resilience. The projected values are not to be considered final or appropriate for construction documents without supporting engineering analyses. The guidance provided within this Tool is intended to be general and users are encouraged to do their own due diligence.

### Applicable Design Criteria

**Projected Tidal Datums:** APPLICABLE

**This project is located in an area with uncertainty for future tidal datums. These uncertain zones are either dynamic in terms of geomorphology or are restricted by manmade features (i.e., culverts, tide gates, etc.) that should be evaluated in more detail at the site-scale.**

**Projected Water Surface Elevation:** APPLICABLE

Asset Name	Recommended Planning Horizon	Recommended Return Period	Max	Min	Area Weighted Average
			(ft - NAVD88)		
Sagamore Bridge	2050	0.1% (1000-Year)	13.5	12.1	12.9
	2070		15.0	13.9	14.5

**Projected Wave Action Water Elevation:** APPLICABLE

Asset Name	Recommended Planning Horizon	Recommended Return Period	Max	Min	Area Weighted Average
			(ft - NAVD88)		
Sagamore Bridge	2050	0.1% (1000-Year)	19.3	12.2	15.2
	2070		21.1	13.9	17.0

**Projected Wave Heights:** APPLICABLE

Asset Name	Recommended Planning Horizon	Recommended Return Period	Max	Min	Area Weighted Average
			(Feet)		
Sagamore Bridge	2050	0.1% (1000-Year)	16.0	0.0	8.5
	2070		16.0	0.0	8.7

**ATTENTION: This project intersects areas that are low probability flooding zones with minimal flood risk and small depth of flooding. These areas are where flooding is expected during the most extreme storm events (> 1000-yr return period) or where there is only minor water depth during the 1000-yr return period. Additional site analyses are recommended to establish design values associated with design criteria.**

**Projected Duration of Flooding:** APPLICABLE

[Methodology to Estimate Projected Values](#)

**Projected Design Flood Velocity:** APPLICABLE

**Projected Scour & Erosion:** APPLICABLE  
[Methodology to Estimate Projected Values](#)

**Extreme Precipitation**

High Risk

Target Planning Horizon: 2070  
Return Period: 100-yr (1%)

**LIMITATIONS:** The recommended Standards for Total Precipitation Depth & Peak Intensity are determined by the user drawn polygon and relationships as defined in the Supporting Documents. The projected Total Precipitation Depth values provided through the Tool are based on the climate projections developed by Cornell University as part of EEA's Massachusetts Climate and Hydrologic Risk Project, GIS-based data as of 10/15/21. For additional information on the methodology of these precipitation outputs, see Supporting Documents.

While Total Precipitation Depth & Peak Intensity for 24-hour Design Storms are useful to inform planning and design, it is recommended to also consider additional longer- and shorter-duration precipitation events and intensities in accordance with best practices. Longer-duration, lower-intensity storms allow time for infiltration and reduce the load on infrastructure over the duration of the storm. Shorter-duration, higher-intensity storms often have higher runoff volumes because the water does not have enough time to infiltrate infrastructure systems (e.g., catch basins) and may overflow or back up during such storms, resulting in flooding. In the Northeast, short-duration high intensity rain events are becoming more frequent, and there is often little early warning for these events, making it difficult to plan operationally. While the Tool does not provide recommended design standards for these scenarios, users should still consider both short- and long-duration precipitation events and how they may impact the asset.

The projected values, standards, and guidance provided within this Tool may be used to inform plans and designs, but they do not provide guarantees for future conditions or resilience. The projected values are not to be considered final or appropriate for construction documents without supporting engineering analyses. The guidance provided within this Tool is intended to be general and users are encouraged to do their own due diligence

**Applicable Design Criteria**

**Tiered Methodology:** Tier 3

**Projected Total Precipitation Depth & Peak Intensity for 24-hr Design Storms:** APPLICABLE

Asset Name	Recommended Planning Horizon	Recommended Return Period (Design Storm)	Projected 24-hr Total Precipitation Depth (inches)	Step-by-Step Methodology for Peak Intensity
Sagamore Bridge	2070	100-Year (1%)	9.8	<a href="#">Downloadable Methodology PDF</a>

**Projected Riverine Peak Discharge & Peak Flood Elevation:** APPLICABLE  
[Methodology to Estimate Projected Values](#) : Tier 3

**Extreme Heat**

High Risk

Target Planning Horizon: 2070  
Percentile: 90th Percentile

**Applicable Design Criteria**

**Tiered Methodology:** Tier 3

**Projected Annual/Summer/Winter Average Temperatures:** APPLICABLE  
[Methodology to Estimate Projected Values](#) : Tier 3

**Projected Heat Index:** APPLICABLE  
[Methodology to Estimate Projected Values](#) : Tier 3

**Projected Growing Degree Days:** NOT APPLICABLE

**Projected Days Per Year With Max Temp > 95°F, >90°F, <32°F:** APPLICABLE  
[Methodology to Estimate Projected Values](#) : Tier 3

**Projected Number of Heat Waves Per Year & Average Heat Wave Duration:** APPLICABLE  
[Methodology to Estimate Projected Values](#) : Tier 3

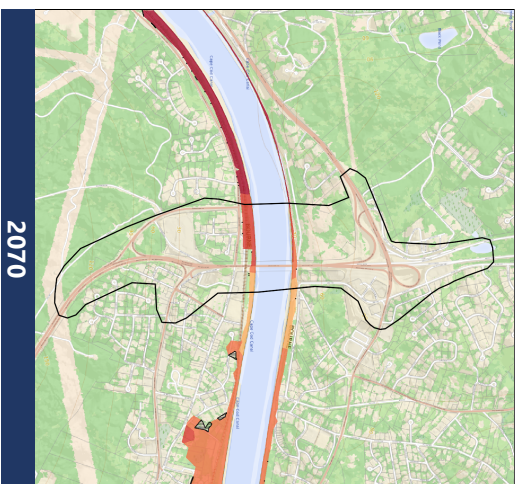
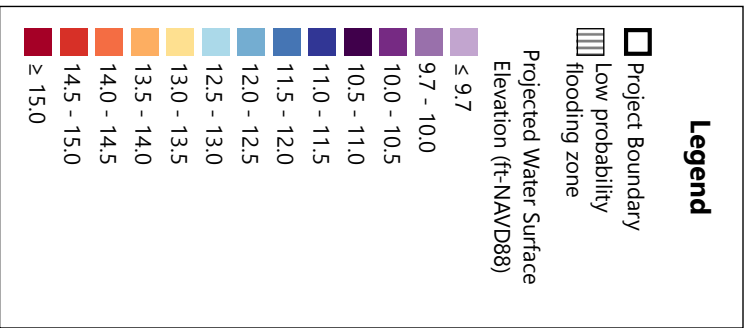
**Projected Cooling Degree Days & Heating Degree Days (base = 65°F):** NOT APPLICABLE

## Sea Level Rise/Storm Surge Project Maps

The following three maps illustrate the Projected Water Surface Elevation for the 2030, 2050, and 2070 planning horizons corresponding to the lowest return period (largest design storm) recommended across the assets identified for this project in the Tool. For projects that only have Natural Resource assets, the maps will show the Projected Water Surface Elevations corresponding to the 5% (20-year) return period. Refer to the Climate Resilience Design Standards Output - Sea Level Rise/Storm Surge Section for additional values associated with other assets. The maps include the project area as drawn by the user with a 0.1 mile minimum buffer, but do not reflect the location of specific assets on the site.

**LIMITATIONS:** The recommended Climate Resilience Design Standards for the Sea Level Rise / Storm Surge Design Criteria are based on the user drawn polygon and relationships as defined in the Supporting Documents. The projected values and maps provided through the Tool are based on the Massachusetts Coast Flood Risk Model (MC-FRM) outputs as of 9/13/2021, which included GIS-based data for three planning horizons (2030, 2050, 2070) and six return periods (0.1%, 0.2%, 0.5%, 1%, 2%, 5%). These values are projections based on assumptions as defined in the model and the LiDAR used at the time. For additional information on the MC-FRM, review the additional resources provided on the Start Here page.

The projected values, maps, Standards, and Guidance provided within this Tool may be used to inform plans and designs, but they do not provide guarantees for future conditions or resilience. The projected values are not to be considered final or appropriate for construction documents without supporting engineering analyses. The guidance provided within this Tool is intended to be general and users are encouraged to do their own due diligence.



**Climate Resilience Design Standards Tool:  
Sea Level Rise/Storm Surge Design Criteria  
Projected Water Surface Elevation Map: 0.1% (1000-yr)**

Project Name: MassDOT Cape Cod Bridge  
 Program - Sagamore  
 Location (Town): Bourne



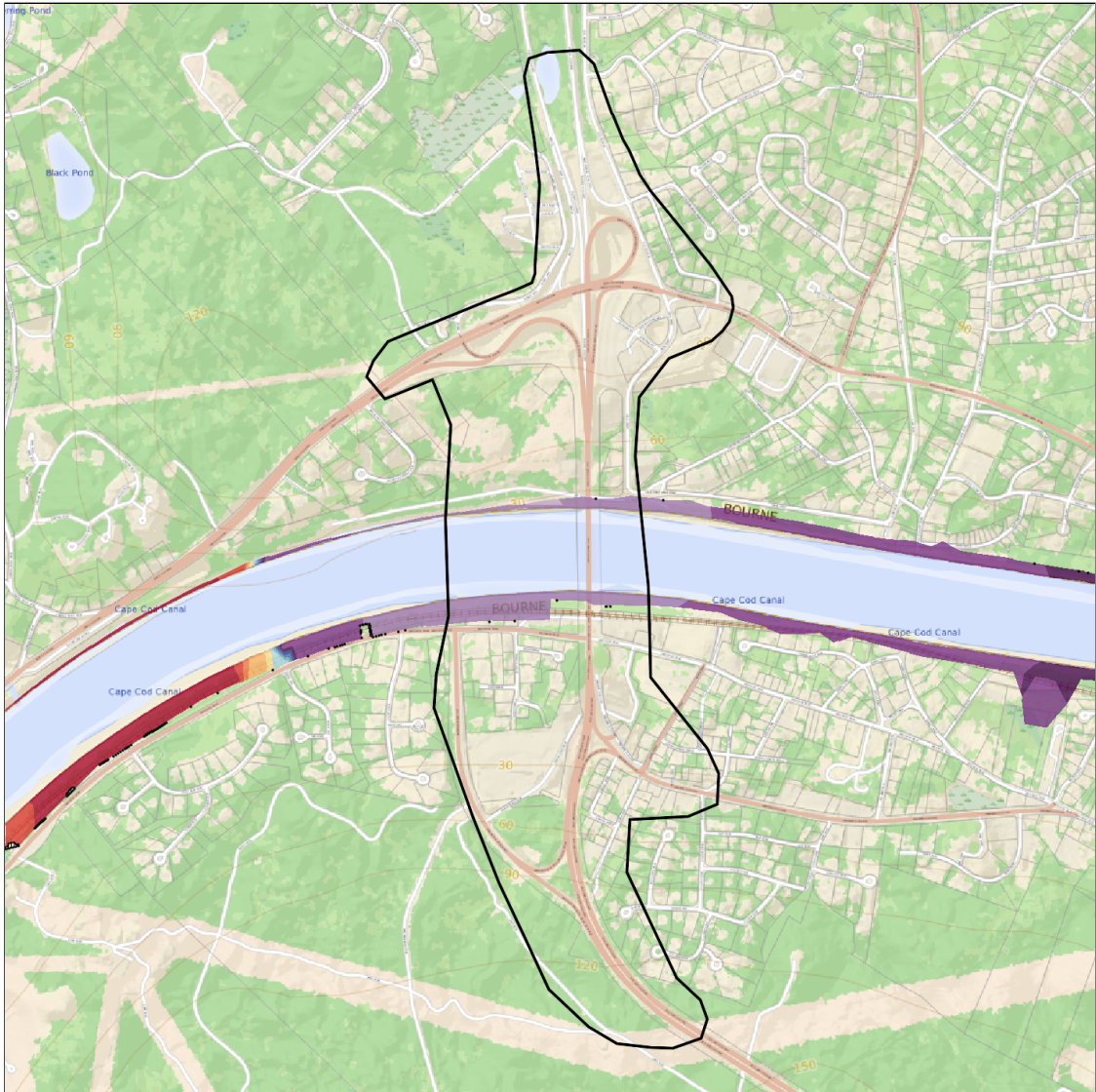
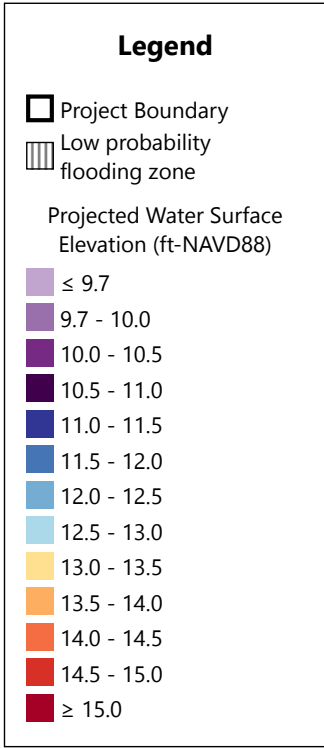
Created by: lomcdonald@hntb.com  
 Date Created: 10/26/2022  
 Tool Version: 1.2



Asset Name	Planning Horizon	Return Period	Max Min		Area Weighted Average (ft-NAVD88)
Sagamore Bridge	2030	0.1% (1000-yr)	9.9	9.7	9.8
	2050	0.1% (1000-yr)	13.5	12.1	12.9
	2070	0.1% (1000-yr)	15.0	13.9	14.5

**ATTENTION: This project intersects areas that are low probability flooding zones with minimal flood risk and small depth of flooding. These areas are where flooding is expected during the most extreme storm events (> 1000-yr return period) or where there is only minor water depth during the 1000-yr return period. Additional site analyses are recommended to establish design values associated with design criteria.**





**Climate Resilience Design Standards Tool:  
Sea Level Rise/Storm Surge Design Criteria  
Projected Water Surface Elevation Map: 2030, 0.1% (1000-yr)**

Project Name: MassDOT Cape Cod Bridge  
 Program- Sagamore  
 Location (Town): Bourne

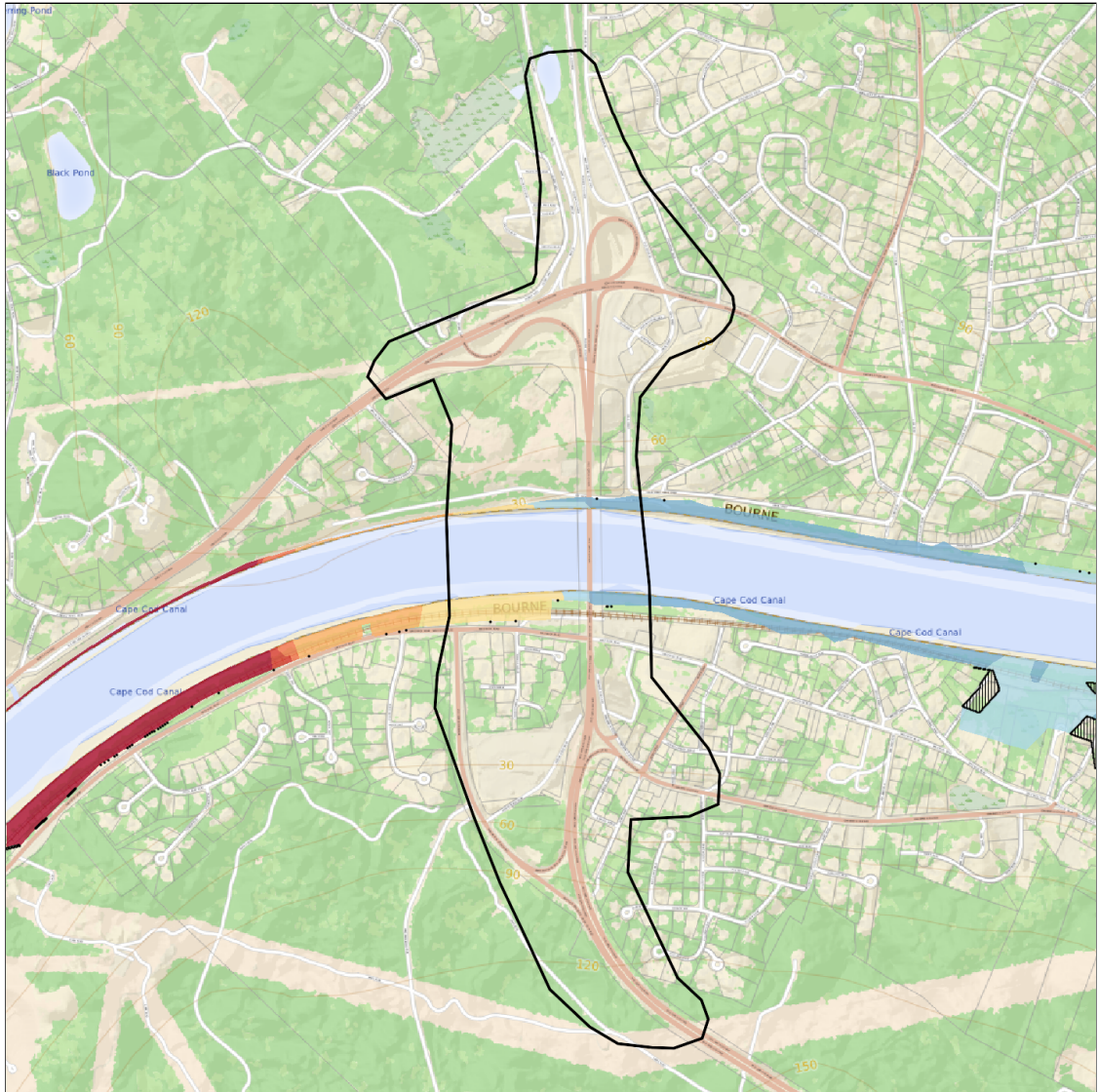
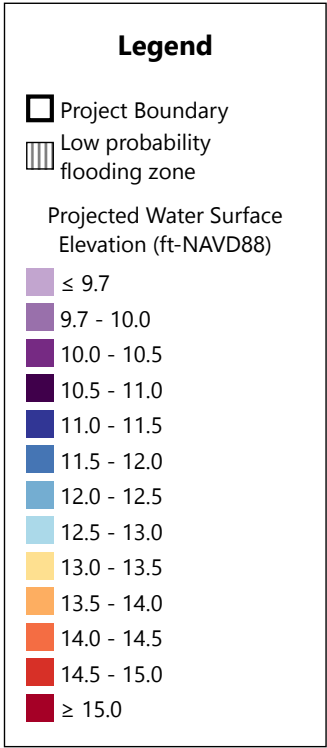


Created by: lomcdonald@hntb.com  
 Date Created: 10/26/2022  
 Tool Version: 1.2



Asset Name	Planning Horizon	Return Period	Max	Min	Area Weighted Average
			(ft-NAVD88)		
Sagamore Bridge	2030	0.1% (1000-yr)	9.9	9.7	9.8

**ATTENTION: This project intersects areas that are low probability flooding zones with minimal flood risk and small depth of flooding. These areas are where flooding is expected during the most extreme storm events (> 1000-yr return period) or where there is only minor water depth during the 1000-yr return period. Additional site analyses are recommended to establish design values associated with design criteria.**



**Climate Resilience Design Standards Tool:  
Sea Level Rise/Storm Surge Design Criteria  
Projected Water Surface Elevation Map: 2050, 0.1% (1000-yr)**

Project Name: MassDOT Cape Cod Bridge  
 Program- Sagamore  
 Location (Town): Bourne

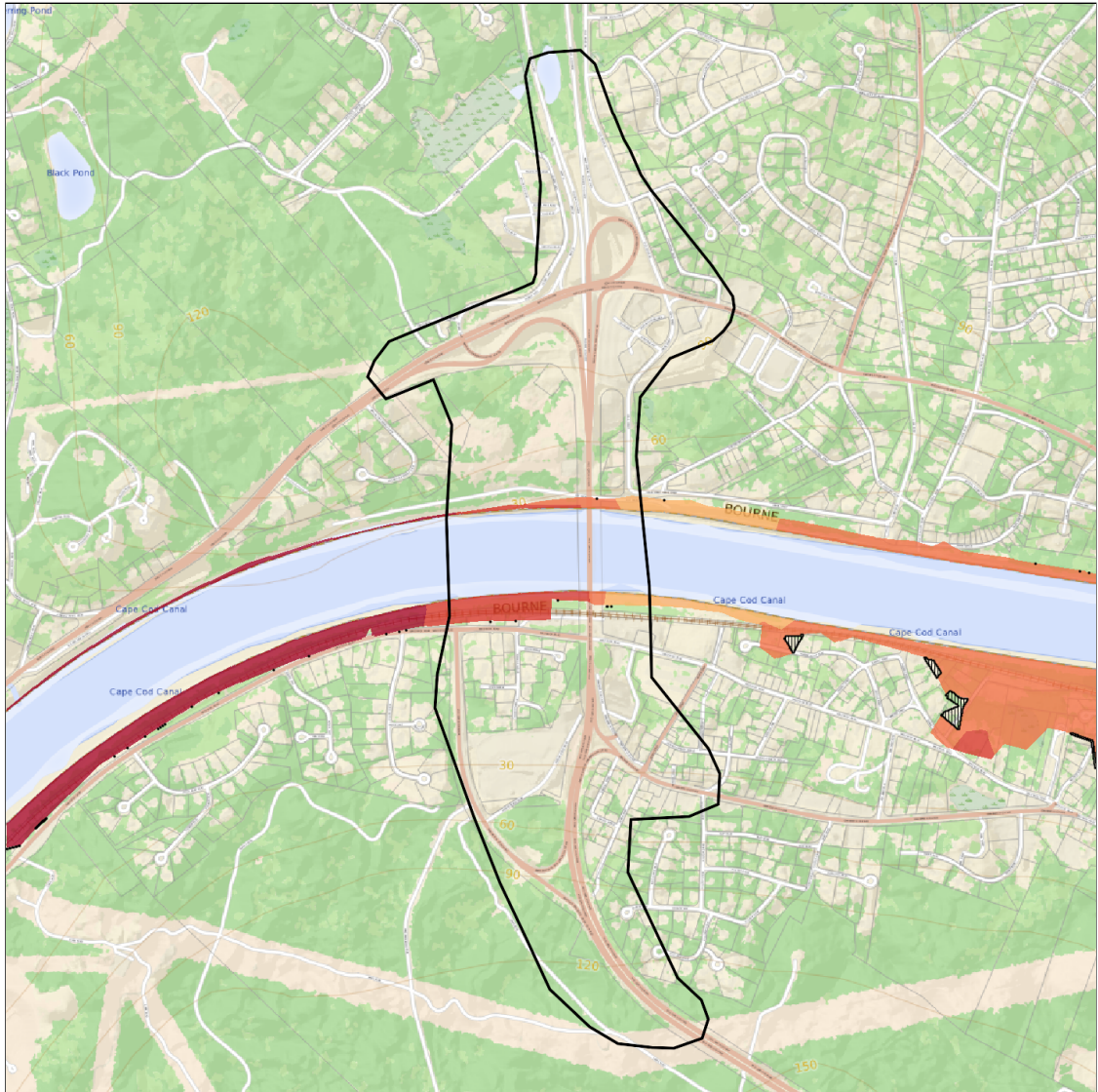
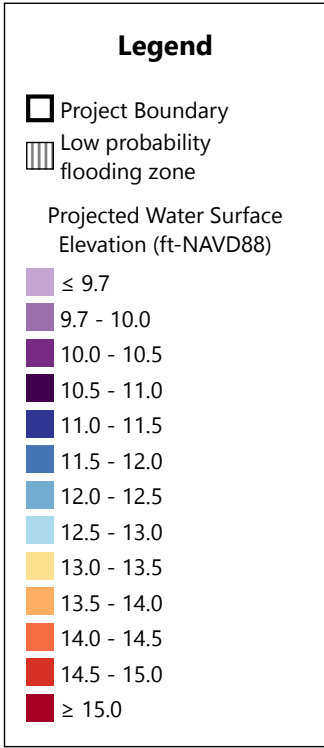


Created by: lomcdonald@hntb.com  
 Date Created: 10/26/2022  
 Tool Version: 1.2



Asset Name	Planning Horizon	Return Period	Max	Min	Area Weighted Average
			(ft-NAVD88)		
Sagamore Bridge	2050	0.1% (1000-yr)	13.5	12.1	12.9

**ATTENTION: This project intersects areas that are low probability flooding zones with minimal flood risk and small depth of flooding. These areas are where flooding is expected during the most extreme storm events (> 1000-yr return period) or where there is only minor water depth during the 1000-yr return period. Additional site analyses are recommended to establish design values associated with design criteria.**



**Climate Resilience Design Standards Tool:  
Sea Level Rise/Storm Surge Design Criteria  
Projected Water Surface Elevation Map: 2070, 0.1% (1000-yr)**

Project Name: MassDOT Cape Cod Bridge  
 Program- Sagamore  
 Location (Town): Bourne



Created by: lomcdonald@hntb.com  
 Date Created: 10/26/2022  
 Tool Version: 1.2



Asset Name	Planning Horizon	Return Period	Max	Min	Area Weighted Average
			(ft-NAVD88)		
Sagamore Bridge	2070	0.1% (1000-yr)	15.0	13.9	14.5

**ATTENTION: This project intersects areas that are low probability flooding zones with minimal flood risk and small depth of flooding. These areas are where flooding is expected during the most extreme storm events (> 1000-yr return period) or where there is only minor water depth during the 1000-yr return period. Additional site analyses are recommended to establish design values associated with design criteria.**

## Project Inputs

### Core Project Information

Name:	MassDOT Cape Cod Bridge Program- Sagamore 2103
Given the expected useful life of the project, through what year do you estimate the project to last (i.e. before a major reconstruction/renovation)?	
Location of Project:	Bourne
Estimated Capital Cost:	\$3,975,000,000
Who is the Submitting Entity?	State Agency Massachusetts Department of Transportation / Department of Transportation Lauren McDonald (lomcdonald@hntb.com)
Is this project identified as an agency priority project, such as in the State Hazard Mitigation and Climate Adaptation Plan (SHMCAP)?	No
Is this project being submitted as part of a state grant application?	No
Which grant program?	
What stage are you in your project lifecycle?	Pre-Planning
Is climate resiliency a core objective of this project?	Yes
Is this project being submitted as part of the state capital planning process?	No
Is this project being submitted as part of a regulatory review process or permitting?	Yes
Brief Project Description:	The preliminary purpose of the Cape Cod Bridges Program (CCBP) is to improve cross-canal mobility and accessibility between Cape Cod and mainland MA for all road users and to address the increasing maintenance needs and functional obsolescence of the aging Cape Cod Canal highway bridges. The program will improve traffic operations and multimodal accommodations to facilitate the dependable and efficient movement of people, goods, and services across the Cape Cod Canal. MassDOT has identified program goals, which include improving traffic operations and safety within the Cape Cod Canal area roadway system, improving/expanding options for non-motorists, avoiding/minimizing/mitigating impacts to adjacent residences, businesses, natural resources, open space, historic/archaeological resources, and ensuring climate resilient infrastructure design. It is anticipated that the project will require the acquisition of permits and approvals consistent with the following regulations: Section 106 of the National Historic Preservation Act, Section 4(f) of the U.S. DOT Act, MA Environmental Policy Act, National Environmental Policy Act, Coastal Zone Management Act, MA Wetlands Protection Act; Section 404 and 401 of the Clean Water Act, Section 14 of the Rivers and Harbors Act, Section 9 of the Rivers and Harbors Appropriations Act, MA Public Waterfront Act, MA Endangered Species Act, and Article 97 of the MA Constitution.

Project Submission Comments:

### Project Ecosystem Service Benefits

#### Factors Influencing Output

- ✓ Project protects public water supply
- ✓ Project recharges groundwater
- ✓ Project filters stormwater using green infrastructure
- ✓ Project improves water quality
- ✓ Project provides recreation
- ✓ Project provides cultural resources/education

#### Factors to Improve Output

- ✓ Incorporate nature-based solutions that may provide flood protection

#### Is the primary purpose of this project ecological restoration?

No

### Project Benefits

Provides flood protection through nature-based solutions	Maybe
Reduces storm damage	No
Recharges groundwater	Yes

Protects public water supply	Yes
Filters stormwater using green infrastructure	Yes
Improves water quality	Yes
Promotes decarbonization	No
Enables carbon sequestration	No
Provides oxygen production	No
Improves air quality	No
Prevents pollution	No
Remediates existing sources of pollution	No
Protects fisheries, wildlife, and plant habitat	No
Protects land containing shellfish	No
Provides pollinator habitat	No
Provides recreation	Yes
Provides cultural resources/education	Yes

### Project Climate Exposure

Is the primary purpose of this project ecological restoration?	No
Does the project site have a history of coastal flooding?	No
Does the project site have a history of flooding during extreme precipitation events (unrelated to water/sewer damages)?	Yes
Does the project site have a history of riverine flooding?	Yes
Does the project result in a net increase in impervious area of the site?	Yes
Are existing trees being removed as part of the proposed project?	Yes

### Project Assets

Asset: Sagamore Bridge  
 Asset Type: Transportation  
 Asset Sub-Type: Bridge  
 Construction Type: New Construction  
 Construction Year: 2028  
 Useful Life: 75

**Identify the length of time the asset can be inaccessible/inoperable without significant consequences.**

Infrastructure must be accessible/operable at all times, even during natural hazard event.

**Identify the geographic area directly affected by permanent loss or significant inoperability of the infrastructure.**

State-wide or greater impacts

**Identify the population directly served that would be affected by the permanent loss or significant inoperability of the infrastructure.**

Greater than 100,000 people

**Identify if the infrastructure provides services to populations that reside within Environmental Justice neighborhoods or climate vulnerable populations.**

The infrastructure provides services to populations that reside within Environmental Justice neighborhoods or climate vulnerable populations.

**Will the infrastructure reduce the risk of flooding?**

No

**If the infrastructure became inoperable for longer than acceptable in Question 1, how, if at all, would it be expected to impact people's health and safety?**

Inoperability of the infrastructure would result in moderate or severe injuries or moderate or severe impacts to chronic illnesses

**If there are hazardous materials in your infrastructure, what are the extents of impacts related to spills/releases of these materials?**

There are no hazardous materials in the infrastructure

**If the infrastructure became inoperable for longer than acceptable in Question 1, what are the impacts on other facilities, assets, and/or infrastructure?**

Debilitating – Inoperability will result in cascading impacts that will render other assets inoperable and/or prevent the functionality of major regional or statewide infrastructure or delivery of critical services

**If the infrastructure was damaged beyond repair, how much would it approximately cost to replace?**

Greater than or equal to \$100 million

**Does the infrastructure function as an evacuation route during emergencies? This question only applies to roadway projects.**

Yes

**If the infrastructure became inoperable for longer than acceptable in Question 1, what are the environmental impacts related to natural resources?**

No impact on surrounding natural resources is expected

**If the infrastructure became inoperable for longer than acceptable in Question 1, what are the impacts to government services (i.e. the infrastructure is not able to serve or operate its intended users or function)?**

Loss of infrastructure may reduce the ability to maintain some government services, while a majority of services will still exist

**What are the impacts to loss of confidence in government resulting from loss of infrastructure functionality (i.e. the infrastructure asset is not able to serve or operate its intended users or function)?**

Loss of confidence in Commonwealth

## Report Comments

N/A

# **Attachment 9 Environmental Justice and Public Involvement Documentation**

[9.1 Environmental Justice Screening Form and Documentation](#)

[9.2 Cape Cod Bridges Program Public Involvement Plan, March 2023](#)

[9.3 Cape Cod Bridges Program FAQs](#)

[9.4 Cape Cod Bridges Program Round 4 FAQs](#)

## 9.1 Environmental Justice Screening Form and Documentation



## EJ Reference List

Organization	Email	Name	Title
Amplify POC	<a href="https://amplifypoccapecod.com/#contact">https://amplifypoccapecod.com/#contact</a>		
Appalachian Mountain Club	hclish@outdoors.org	Heather Clish	Director of Conservation & Recreation Policy
Arts Foundation of Cape Cod	info@artsfoundation.org		
Bourne Conservation Commission	rgray@townofbourne.com	Robert Gray	Chairperson
Bourne Fire and Emergency Services	dcody@townofbourne.com	David Cody	Fire Chief
Bourne Historic Commission	clgeorgeson@gmail.com	Carl Georgeson	Chairperson
Bourne Police Department	pshastany@townofbourne.com	Paul Shastany	Director of Police Services
Bourne Recreation Department	kcaron@townofbourne.com	Krissanne Caron	Director
Bourne Recreation Department	kmatthews@townofbourne.com	Kathryn Matthews	Assistant Director
Bourne Water District	handycranberry@aol.com or bourneh20@aol.com	Brian Handy	Chairman
Browning the GreenSpace	kerry@msaadapartners.com	Kerry Bowie	Board President
Buzzards Bay Water District	ssouza@bbwd.us	Steven Souza	Superintendent
Cape Cod Pride	pam@capecodpride.org		
Cape Cod Zion Heritage Museum	zuhmi@comcast.net		
Cape Organization for Rights of the Disabled	cordinfo@cilcapecod.org		
Chappaquiddick Tribe of the Wampanoag Nation	tribalcouncil@chappaquiddick-wampanoag.org	Alma Gordon	President
Chappaquiddick Tribe of the Wampanoag Nation, Whale Clan	rockerpatriciad@verizon.net	Patricia D. Rocker	Council Chair
Chaubunagungamaug Nipmuck Indian Council	acw1213@verizon.net	Kenneth White	Council Chairman
Clean Water Action	cluppi@cleanwater.org	Cindy Luppi	New England Director
Commission on Disabilities	<a href="https://www.townofbourne.com/users/dpelonzi/contact">https://www.townofbourne.com/users/dpelonzi/contact</a>		
Community Action Committee of Cape Cod & Islands	info@cacci.cc		
Community Action Works	sylvia@communityactionworks.org	Sylvia Broude	Executive Director
Conservation Law Foundation	srubin@clf.org	Staci Rubin	Senior Attorney
Council on Aging	elizabeth@mcoaonline.com		
Deaf, INC. – Hyannis Chapter	<a href="https://www.deafinonline.org/contact">https://www.deafinonline.org/contact</a>		
Department of Public Works	ptilton@sandwichmass.org	Paul Tilton	Director
Department of Public Works	spatterson@townofbourne.com	Shawn Patterson	Director
E4TheFuture	pstanton@e4thefuture.org	Pat Stanton	Project Manager
Environment Massachusetts	ben@environmentmassachusetts.org	Ben Hellerstein	MA State Director
Environmental League of MA	ngoodman@environmentalleague.org	Nancy Goodman	Vice President for Policy
Healthcare without Harm	wvaughan@hcwh.org	Winston Vaughan	Director of Climate Solutions
Herring Pond Wampanoag Tribe	melissa@herringpondtribe.org	Melissa Ferretti	Chair
Housing Assistance Corporation	hac@haccapecod.org		
Lower Cape Outreach Council	lcoc@lcoutreach.org		
Mashpee Wampanoag Tribe	publicrelations@mwtribe-nsn.gov		
Mass Audubon	hricci@massaudubon.org	Heidi Ricci	Director of Policy
Mass Climate Action Network (MCAN)	sarah@massclimateaction.net	Sarah Dooling	Executive Director
Mass Land Trust Coalition	robb@massland.org	Robb Johnson	Executive Director
Mass Rivers Alliance	juliablatt@massriversalliance.org	Julia Blatt	Executive Director
Massachusetts Commission on Indian Affairs (MCIA)	john.peters@mass.gov	John Peters, Jr.	Executive Director
Massachusetts Statewide Independent Living Council	sadie@masilc.org		
MEPA Office	MEPA-EJ@mass.gov		
Museum of African American History	history@maah.org		
Neighbor to Neighbor	elvis@n2nma.org	Elvis Mendez	Organizing Director
Nipmuc Nation (Hassanamisco Nipmucs)	crwritings@aol.com	Cheryll Toney Holley	Chair
North American Indian Center of Boston	rhalsey@naicob.org	Raquel Halsey	Executive Director
North Sagamore Water District	matt-nswd@comcast.net	Matt Sawicki	Superintendent
Ocean River Institute	rob@oceanriver.org	Rob Moir	Executive Director
Sandwich Conservation Commission	ddeconto@sandwichmass.org	David DeConto	Chairperson
Sandwich Fire Department	jburke@sandwichmass.org	John Burke	Fire Chief
Sandwich Historic Commission	julia.blakely@yahoo.com	Julia Blakely	Chairperson
Sandwich Planning Board	rvitacco@sandwichmass.org	Ralph Vitacco	Director of Planning and Economic Development
Sandwich Police Department	jkeene@sandwichmass.org	Jason Keene	Police Chief
Sandwich Recreation Department	gboucher@sandwichmass.org	Guy Boucher	Director
Sandwich Recreation Department	tmacdonald@sandwichmass.org	Tricia MacDonald	Assistant Director
Sandwich Water District	dmahoney@sandwichmass.org	Dan Mahoney	Chairman

## EJ Reference List

Sierra Club MA	deb.pasternak@sierraclub.org	Deb Pasternak	Director, MA Chapter
South Shore Community Action Council	news@sscac.org		
The African American Heritage Trail of Martha's Vineyard	mvafricanamericanheritagetrail.org		
The Trust for Public Land	kelly.boling@tpl.org	Kelly Boling	MA & RI State Director
Town of Bourne	mmccollem@townofbourne.com	Marlene McCollem	Town Administrator
Town of Bourne Board of Selectmen	pmeier@townofbourne.com	Peter Meier	Chairman
Town of Bourne Board of Selectmen	jfroman@townofbourne.com	Judith MacLeod Froman	Member
Town of Bourne Board of Selectmen	jmacdonald@townofbourne.com	Jared MacDonald	Vice Chairman
Town of Bourne Board of Selectmen	mmastrangelo@townofbourne.com	Mary Jane Mastrangelo	Member
Town of Bourne Board of Selectmen	mferretti@townofbourne.com	Melissa Ferretti	Town Clerk
Town of Bourne Planning Board	jcopeland@townofbourne.com	Jennifer Copeland	Town Planner
Town of Sandwich	gdunham@sandwichmass.org	George Dunham	Town Administrator
Town of Sandwich	twhite@sandwichmass.org	Taylor White	Town Clerk
Town of Sandwich Selectmen	shoctor@sandwichmass.org	Shane Hoctor	Chairman
Town of Sandwich Selectmen	cholden@sandwichmass.org	Charles Holden	Vice Chairman
Unitarian Universalist Mass Action Network	tsmookler@uumassaction.org	Tali Smookler	Organizing Director
Wampanoag Tribe of Gay Head (Aquinnah)	thpo@wampanoagtribe-nsn.gov	Bettina Washington	Tribal Historic Preservation Officer
Wampanoag Tribe of Gay Head (Aquinnah)	planning@wampanoagtribe-nsn.gov		
Wampanoag Tribe of Herring Pond	Herring Pond Wampanoag Tribe (list-manage.com)		
Woods Hole Diversity Advisory Committee	woodsholedac@gmail.com		

To whom it may concern,

As an identified project stakeholder, you are receiving the attached Environmental Justice (EJ) Screening Form in English, Spanish, and Portuguese, serving as advanced notification of the Massachusetts Environmental Policy Act (MEPA) Environmental Notification Form (ENF) filing for the Cape Cod Bridge Program in accordance with 301 CMR 11.05(4). The ENF is scheduled to be included in the May 10, 2023 publication of the Environmental Monitor.

In coordination with the Federal Highway Administration and the U.S. Army Corps of Engineers, the Massachusetts Department of Transportation is proposing to replace the Bourne and Sagamore highway bridges, as well as improve the approaching roadway networks on both sides of the Cape Cod Canal.

The EJ Screening Form provides a description of the project and identified EJ populations and characteristics within 1- and 5-miles of the project site. Pursuit to *An Act Creating a Next-Generation Roadmap for Massachusetts Climate Policy*, the statutory definition of “EJ population” includes four categories of neighborhoods (defined as census block groups) with certain demographic characteristics based on median income level, percentage of residents who are of color, and percentage of residents who have limited English proficiency (LEP). More information is available on the [MEPA website](#).

Sincerely,

Mikayla Jerominek  
Environmental Planner  
Community and Public Engagement

HNTB CORPORATION  
CELEBRATING 65 YEARS IN MASSACHUSETTS  
31 St. James Avenue, Suite 300, Boston, MA 02116 | [www.hntb.com](http://www.hntb.com)

A quien le corresponda,

Como parte interesada identificada del proyecto, usted está recibiendo el Formulario de Evaluación de Justicia Ambiental (EJ) adjunto en inglés, español, y en portugués, que sirve como notificación con anticipo del Formulario de Notificación Ambiental (ENF) de la Ley de Política Ambiental de Massachusetts (MEPA) que representa el Programa del Puente de Cape Cod de acuerdo con 301 CMR 11.05 (4). El ENF está programado para ser incluido en la publicación del Monitor Ambiental del 10 de Mayo de 2023.

En coordinación con la Administración Federal de Carreteras y el Cuerpo de Ingenieros del Ejército de los Estados Unidos, el Departamento de Transporte de Massachusetts propone reemplazar los puentes de las autopistas Bourne y Sagamore, así como mejorar las redes de carreteras que se aproximan a ambos lados del Canal de Cape Cod.

El Formulario de Evaluación de EJ proporciona una descripción del proyecto y de las poblaciones y características identificadas de EJ dentro de 1 y 5 millas del sitio del proyecto. Persecución a una ley que crea una hoja de ruta de próxima generación para la política climática de Massachusetts, la definición legal de “población EJ” incluye cuatro categorías de vecindarios (definidos como grupos de bloques censales) con ciertas características demográficas basadas en el nivel medio de ingresos, porcentaje de

residentes que son personas de color (minorías) y porcentaje de residentes que tienen dominio limitado del inglés (LEP). Más información está disponible en el sitio web de (MEPA).

Sinceramente,

Mikayla Jerominek  
Environmental Planner  
Community and Public Engagement

HNTB CORPORATION  
CELEBRATING 65 YEARS IN MASSACHUSETTS  
31 St. James Avenue, Suite 300, Boston, MA 02116 | [www.hntb.com](http://www.hntb.com)

A quem possa interessar,

Como parte interessada no projeto, você está recebendo anexo o formulário de triagem da Justiça Ambiental (Environmental Justice (EJ)) em Inglês, Espanhol, e Português, servindo como notificação antecipada da Lei de Política Ambiental de Massachusetts (Massachusetts Environmental Policy Act (MEPA)) Formulário de Notificação Ambiental (Environmental Notification Form (ENF)) registrado para o Programa da Ponte de Cape Cod de acordo com 301 CMR 11.05(4). O Formulário de Notificação Ambiental está agendado para ser incluído na publicação do Monitor Ambiental do dia 10 de Maio de 2023.

Em coordenação com o Administração Rodoviária Federal (Federal Highway Administration) e o Corpo de Engenheiros do Exército dos EUA (U.S. Army Corps of Engineers), o Departamento de Transporte de Massachusetts (MassDOT) está propondo substituir as pontes da Bourne e Sagamore, bem como melhorar as redes rodoviárias em ambos os lados próximo ao Canal de Cape Cod.

O formulário de triagem da Justiça Ambiental fornece a descrição do projeto e as populações da Justiça Ambiental identificadas e as características dentro de 1,6 e 8,0 Km (1 e 5 pés) do local do projeto. A fim de alcançar Uma Lei que Cria o Roteiro da Próxima- Geração para a Política de Climática de Massachusetts (An Act Creating a Next-Generation Roadmap for Massachusetts Climate Policy), a definição estatutária de “população da Justiça Ambiental” inclui quatro categorias de vizinhanças (definida como grupos de quarteirões censitários) com certas características demográficas baseada no nível médio de rendimento, percentual de residentes que são pessoas de cor (ou seja, minoria), e percentual de residentes com proficiência limitada em Inglês. Mais informações estão disponíveis no site [MEPA](#).

Sinceramente,

Mikayla Jerominek  
Environmental Planner  
Community and Public Engagement

HNTB CORPORATION  
CELEBRATING 65 YEARS IN MASSACHUSETTS  
31 St. James Avenue, Suite 300, Boston, MA 02116 | [www.hntb.com](http://www.hntb.com)

## Environmental Justice Screening Form

Project Name	Cape Cod Bridges Program
Anticipated Date of MEPA Filing	05/01/2023
Proponent Name	Massachusetts Department of Transportation (MassDOT) – Highway Division
Contact Information	Bryan Cordeiro, MassDOT Cape Cod Bridges Program Manager, bryan.cordeiro@state.ma.us
Public website for project or other physical location where project materials can be obtained	<a href="https://www.mass.gov/cape-bridges">https://www.mass.gov/cape-bridges</a>
Municipality and Zip Code for Project	Bourne, MA 02532
Project Type* (list all that apply)	Transportation – roadways/transit, Transportation – trails, Recreation
Is the project site within a mapped 100-year FEMA flood plain?	Yes
Estimated GHG emissions of conditioned spaces ( <a href="#">click here for GHG Estimation tool</a> )	N/A

### Project Description

1. Provide a brief project description, including overall size of the project site and square footage of proposed buildings and structures if known.

In coordination with the Federal Highway Administration (FHWA) and the New England District of the U.S. Army Corps of Engineers (USACE), the Massachusetts Department of Transportation (MassDOT) is proposing to replace the Bourne and Sagamore highway bridges, as well as improve the approaching roadway networks on both sides of the Cape Cod Canal. The Program Study Areas include the areas of the existing bridges and the two highway approach intersections for each crossing. The purpose of the Cape Cod Bridges Program (the Program) is to improve cross-canal mobility and accessibility between Cape Cod and mainland Massachusetts for all road users and to address the increasing maintenance needs and functional obsolescence of the aging Cape Cod Canal highway bridges. The Program will improve traffic operations and multimodal accommodations to facilitate the dependable and efficient movement of people, goods, and services across the Cape Cod Canal.

The Program is needed to address the existing transportation-related problems and unsatisfactory conditions of the existing bridges, including: the functional obsolescence of the bridges; the unsatisfactory structural conditions of the bridges and their frequent maintenance requirements; and the peak period congestion and traffic conditions.

2. List anticipated MEPA review thresholds (301 CMR 11.03)

- 301 CMR 11.03(1)(a)1. Direct alteration of 50 or more acres of land.
- 301 CMR 11.03(1)(a)2. Creation of ten or more acres of impervious area.
- 301 CMR 11.03(6)(b)1.b. Widening of an existing roadway by four or more feet for one-half or more miles.
- 301 CMR 11.03(6)(b)2.a. Construction/widening of a roadway or its right-of-way that will alter the bank or terrain located ten more feet from the existing roadway for one-half or more miles.

- 301 CMR 11.03(6)(b)2.b. Construction/widening of a roadway or its right-of-way that will cut five or more living public shade trees of 14 or more inches in diameter at breast height.

3. List all anticipated state, local and federal permits needed for the project

Authority	Regulation	Permit/Regulatory Approval
<b>Federal</b>		
Federal Highway Administration (FHWA)	National Environmental Policy Act (NEPA)	NEPA Decision
FHWA, Official(s) with Jurisdiction	Section 4(f) of the United States Department of Transportation Act	Section 4(f) Approval
Federal Aviation Administration	Notice of Construction (14 CFR 77)	Approval
U.S. Army Corps of Engineers (USACE)	Section 404 of the Clean Water Act	Section 404 Permit
	Section 14 of the Rivers and Harbors Act, 33 U.S.C 408 (Section 408)	Section 408 Approval
	43 CFR 7.00; Protection of Archaeological Resources	Federal Archaeologist Permit
U.S. Coast Guard	Section 9 of the Rivers and Harbors Appropriations Act	U.S. Coast Guard Section 9 Bridge Permit
U.S. Fish and Wildlife Service	Section 7 of the Endangered Species Act	Section 7 Approval
	Migratory Bird Treaty Act	Review
	Bald and Golden Eagle Protection Act	Review
	Fish and Wildlife Coordination Act	Review
National Marine Fisheries Service, Greater Atlantic Regional Fisheries Office	Magnuson-Stevens Fishery Conservation and Management Act	Essential Fish Habitat Determination
	Section 7 of the Endangered Species Act	Section 7 Approval
U.S. Environmental Protection Agency (EPA)	National Pollution Discharge Elimination System (NPDES)	Construction General Permit
EPA and Massachusetts Department of Environmental Protection (MassDEP)		Massachusetts Small Municipal Separate Storm Sewer Systems (MS4) Permit
FHWA, Massachusetts Department of Transportation (MassDOT), Massachusetts State Historic Preservation Officer	Section 106 of the National Historic Preservation Act	Memorandum of Agreement
<b>State</b>		
Massachusetts Executive Office of Energy and Environmental Affairs	Massachusetts Environmental Policy Act (MEPA); 301 CMR 11.00	MEPA Approval
Massachusetts Historical Commission	950 CMR 70.00 Massachusetts State Historical Commission	State Archaeologist Permit
Massachusetts Office of Coastal Zone Management	Coastal Zone Management Act (CZM); 301 CMR 20.00	CZM Federal Consistency Review
MassDEP	Section 401 of the U.S. Clean Water Act	Section 401 Water Quality Certificate
	Massachusetts Public Waterfront Act,	Chapter 91 Waterways

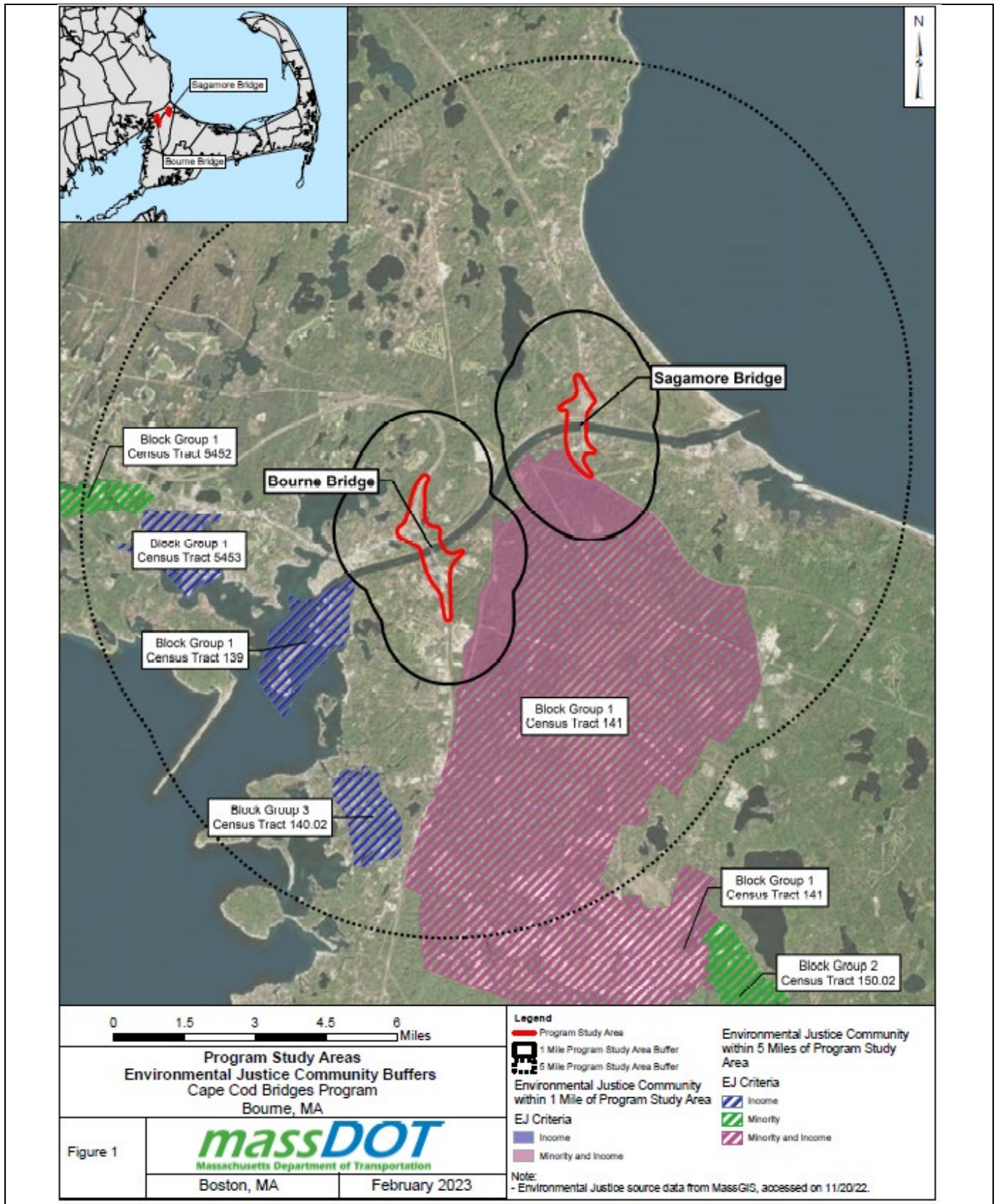
	Chapter 91; 310 CMR 9.00	License
Massachusetts Division of Fisheries and Wildlife	Massachusetts Endangered Species Act (MESA); 321 CMR 10.00	MESA Conservation & Management Permit
Massachusetts State Legislature	Article 97 of the Constitution of the Commonwealth of Massachusetts	Article 97 Land Disposition
MassDOT	Approval of Access to Massachusetts Department of Transportation highways and other property; 700 CMR 13.00	State Highway Access Permit
<b>Local</b>		
Bourne Conservation Commission	Massachusetts Wetlands Protection Act (MA WPA); 310 CMR 10.00	Order of Conditions

4. Identify EJ populations and characteristics (Minority, Income, English Isolation) within 5 miles of project site (can attach map identifying 5-mile radius from [EJ Maps Viewer](#) in lieu of narrative)

The following EJ populations are located within five miles of the Bourne and Sagamore Bridges, as shown on the figure below:

- Block Group 1, Census Tract 139, Bourne, Barnstable County – Income
- Block Group 3, Census Tract 140.02, Bourne, Barnstable County – Income
- Block Group 1, Census Tract 141, Bourne, Barnstable County – Minority and Income
- Block Group 1, Census Tract 141, Sandwich, Barnstable County – Minority and Income
- Block Group 1, Census Tract 5452, Wareham, Plymouth County – Minority
- Block Group 1, Census Tract 5453, Wareham, Plymouth County –Income

The EJ area within the Sagamore Program Area is associated with Joint Base Cape Cod (Block Group 1, Census Tract 141). Of the 22,000-acre property, 15,000 undeveloped acres comprise the northern training area. A total of 161 residential units provides Coast Guard family housing for almost 2,000 residents in the southern area of the site located at least five miles from the Bridges. EJ areas within five miles of the Program Study Area and south of the Canal include Gray Gables (Block Group 1, Census Tract 139) and Pocasset (Block Group 3, Census Tract 140.02) within Bourne. EJ areas within five miles of the Program Study Area north of the Canal on the mainland include East Wareham (Block Group1, Census Tract 139) and Wareham (Block Group 1, Census Tract 5424).





5. Identify any municipality or census tract meeting the definition of “vulnerable health EJ criteria” in the [DPH EJ Tool](#) located in whole or in part within a 1 mile radius of the project site

The vulnerable EJ health criteria for childhood lead exposure and low birth weight are evaluated at the Census Tract level. The vulnerable EJ health criteria for childhood lead exposure or low birth weight are not met by Census Tracts located in whole, or in part, within one mile of the Program study areas.

The vulnerable EJ health criteria for heart attacks and childhood asthma are evaluated at the municipal level for those municipalities located in whole, or in part, within one mile of the Program Study Areas (Bourne, Sandwich, and Wareham). The vulnerable EJ health criterion for heart attacks is met for Bourne. The vulnerable EJ health criterion for both heart attacks and childhood asthma is met for Wareham. See table below for further details.

Municipality	Health outcome	Year range	Municipality rate	110 percent of statewide rate	Vulnerable Health EJ Criteria met by at least one block group
Bourne	Heart Attack	2013-2017	36.8	29.1	Yes
Wareham	Heart Attack	2013-2017	43.5	29.1	Yes
Wareham	Childhood Asthma	2013-2017	98.1	91.4	Yes

6. Identify potential short-term and long-term environmental and public health impacts that may affect EJ Populations and any anticipated mitigation

Based on conceptual design, impacts are projected to occur to properties adjacent to the Bourne and Sagamore bridges and the associated approach roadway networks, which are not located within EJ areas. EJ populations in Gray Gables and Pocasset villages and JBCC, further removed from the Program Study Areas, could experience impacts, albeit to a lesser extent, because they likely travel over the canal on a regular basis to access Buzzard’s Bay downtown and other community amenities in Bourne, including Bourne Elementary School.

MassDOT is evaluating Program design options that would maximize constructability, reduce complexity relative to staging and the need for temporary structures, and limit impacts upon the traveling public. To the maximum extent possible, construction of the Program would include maintaining two traffic lanes in each direction at each crossing and maintaining connections to the local roadway network at locations like existing conditions. The Program would deploy Smart Work Zones and real-time traffic management devices to manage traffic and increase safety for construction workers and the traveling public. Sensors, cameras, and changeable message signs would be deployed to provide real-time information to motorists such as travel times, speed warnings, dynamic merge feedback, queue warnings, and truck warnings.

The proposed improvements would not trigger any MEPA Environmental Notification Form (ENF) or mandatory Environmental Impact Report (EIR) review thresholds for air quality, hazardous waste, or wastewater. Due to the replacement of the National Register of Historic Places (NRHP)-eligible Bourne and Sagamore bridges, the Program would result in an Adverse Effect to these two historic resources under Section 106 of the National Historic Preservation Act (NHPA). MassDOT is designing the bridge replacements to avoid and/or minimize impacts to the NRHP-eligible Cape Cod Canal District.

Throughout Program design, MassDOT would incorporate measures to avoid and minimize impacts to protected resources. For unavoidable impacts, MassDOT would provide mitigation in consultation with the applicable resource agencies.

Right-of-way impacts have been evaluated based on conceptual design. None of the takings potentially required for the Program are anticipated to occur within EJ designated areas. As design advances and

impacts are confirmed, MassDOT proposes to implement the right-of-way acquisition process in compliance with the Relocation Assistance and Real Property Acquisition Policies Act of 1970 (Uniform Act) (amended in 1987), and Massachusetts General Laws, primarily Chapter 79.

MassDOT is committed to ensuring that no person is excluded from participation, denied benefits, or otherwise subjected to discrimination, regardless of race, color, national origin, sex, age, and disability. The MassDOT Title VI/Nondiscrimination Program for FHWA oversees civil rights compliance in the Massachusetts Highway Division. MassDOT has a Diversity and Civil Rights External Operations Program for federally funded projects.

In coordination with FHWA and MEPA, MassDOT has produced a robust Public Involvement Plan (PIP) guided by the principles of comprehensive outreach, as well as a Community Demographic Analysis and Engagement Plan. Together, the PIP and the Community Demographic Analysis and Engagement Plan set forth measures of effectiveness that are used to evaluate outreach and adapt as needed, particularly in historically underserved communities.

7. Identify project benefits, including “Environmental Benefits” as defined in 301 CMR 11.02, that may improve environmental conditions or public health of the EJ population

The improvements to travel patterns across the bridges and reduced congestion at the interchanges could serve to decrease the sense of separation between the portions of Bourne located to the north and south of the canal. Additionally, improvements at the interchanges would increase east-west connectivity on either side of the canal. It is anticipated the safety and design upgrades to facilities for alternative modes of travel and new portions of multimodal facilities would increase trips by pedestrians and bicyclists, which could contribute positively to health outcomes in the area. These benefits would be experienced by both EJ and non-EJ areas overall.

Adverse impacts to EJ census geographies within the Program Study Areas are not anticipated. The Program would correct existing operational deficiencies and improve safety conditions at the bridge sites and approach intersections, thereby reducing congestion, improving travel times, and maintaining and enhancing connectivity. The Program would result in substantial benefits to commuters, residents, and visitors to the town of Bourne and Cape Cod. In consideration of the overall transportation and quality of life benefits to the immediate locale and region, disproportionately high and adverse impacts to EJ populations are not anticipated.

8. Describe how the community can request a meeting to discuss the project, and how the community can request oral language interpretation services at the meeting. Specify how to request other accommodations, including meetings after business hours and at locations near public transportation.

For general information, visit the project website: [www.mass.gov/cape-bridges](http://www.mass.gov/cape-bridges). To leave a comment online, visit: [https://pima.massdotpi.com/public/comment/project-comment-dynamic?project\\_id=13868](https://pima.massdotpi.com/public/comment/project-comment-dynamic?project_id=13868). Project inquiries, including requests for meetings, may be e-mailed to: [MassDOTMajorProjects@dot.state.ma.us](mailto:MassDOTMajorProjects@dot.state.ma.us). Any written statements regarding the proposed undertaking can be submitted to:

*Carrie Lavalley, P.E. Chief Engineer  
Massachusetts Department of Transportation  
Attn: Project Management, Project File No. 608020  
10 Park Plaza  
Boston, MA 02116*

MassDOT provides reasonable accommodations and/or language assistance free of charge upon request, as appropriate. To request accommodation or language assistance, please contact MassDOT's Chief Diversity and Civil Rights Officer by phone (857-468-8580), TTD/TTY at (857) 266-0603, fax (857) 368-0602, or e-mail [MassDOT.CivilRights@dot.state.ma.us](mailto:MassDOT.CivilRights@dot.state.ma.us). Requests should be made as soon as possible prior to the meeting, and for more difficult to arrange services including sign-language, CART or language translation or interpretation, requests should be made at least ten business days before the meeting.

## Formulario informativo de justicia medioambiental

Nombre del proyecto	Cape Cod Bridges Program
Fecha prevista de presentación ante la MEPA	05/01/2023
Nombre del proponente	Massachusetts Department of Transportation (MassDOT) – Highway Division
Información de contacto	Bryan Cordeiro, Gestor del programa MassDOT Cape Cod Bridges, <a href="mailto:bryan.cordeiro@state.ma.us">bryan.cordeiro@state.ma.us</a>
Sitio web público del proyecto u otro lugar físico donde se puedan obtener los materiales del proyecto	<a href="https://www.mass.gov/cape-bridges">https://www.mass.gov/cape-bridges</a>
Municipio y código postal del proyecto	Bourne, MA 02532
Tipo de proyecto* (indique todos los que correspondan)	Transporte - carreteras/tránsito, Transporte - senderos, Ocio
¿Se encuentra el emplazamiento del proyecto dentro de una zona de inundación de 100 años cartografiada por la FEMA?	Sí
Estimación de las emisiones de GEI de los espacios acondicionados ( <a href="#">pulse aquí para acceder a la herramienta de estimación de GEI</a> )	N/A

### Descripción del proyecto

<p>1. Proporcionar una breve descripción del proyecto, incluyendo el tamaño total del emplazamiento del proyecto y los metros cuadrados de los edificios y estructuras propuestos, si se conocen</p> <p>En coordinación con la Administración Federal de Carreteras (FHWA) y el Distrito de Nueva Inglaterra del Cuerpo de Ingenieros del Ejército de EE. UU. (USACE), el Departamento de Transporte de Massachusetts (MassDOT) propone sustituir los puentes de las autopistas de Bourne y Sagamore, así como mejorar las redes de carreteras de aproximación a ambos lados del Canal de Cape Cod. Las áreas de estudio del programa incluyen las zonas de los puentes existentes y las dos intersecciones de aproximación a la autopista de cada cruce. El propósito del programa Cape Cod Bridges (el Programa) es mejorar la circulación a través del canal y la accesibilidad entre Cape Cod y el territorio continental de Massachusetts para todos los usuarios de las carreteras y hacer frente a las crecientes necesidades de mantenimiento y a la obsolescencia funcional de los envejecidos puentes de las autopistas del Canal de Cape Cod. El Programa mejorará las operaciones de tráfico y los acondicionamientos multimodales para facilitar el movimiento fiable y eficaz de personas, bienes y servicios a través del Canal de Cape Cod.</p> <p>El Programa es necesario para abordar los problemas existentes relacionados con el transporte y las condiciones desfavorables de los puentes existentes, incluyendo: la obsolescencia funcional de los puentes; las insatisfactorias condiciones estructurales de los puentes y sus frecuentes requisitos de mantenimiento; y la congestión y las condiciones del tráfico en las horas de mayor tráfico.</p>
---

2. Indicar los criterios de revisión de la MEPA previstos (301 CMR 11.03)

- 301 CMR 11.03 (1)(a)1. Alteración directa de 50 o más acres de terreno.
- 301 CMR 11.03(1)(a)2. Creación de diez o más acres de superficie impermeable
- 301 CMR 11.03(6)(b)1.b. Ensanche de una calzada existente en cuatro pies o más a lo largo de media milla o más.
- 301 CMR 11.03(6)(b)2.a. Construcción/ampliación de una calzada o de su derecho de paso que altere la orilla o el terreno situado a diez pies más de la calzada existente a lo largo de media milla o más.
- 301 CMR 11.03(6)(b)2.b. Construcción/ampliación de una carretera o de su derecho de paso que talará cinco o más árboles de sombra públicos vivos de 14 pulgadas o más de diámetro a la altura del pecho.

3. Indicar todos los permisos estatales, locales y federales previstos necesarios para el proyecto

<b>Autoridad</b>	<b>Reglamento</b>	<b>Permiso/aprobación reglamentaria</b>
<b>Federal</b>		
Administración Federal de Carreteras (FHWA)	Ley Nacional de Política Medioambiental (NEPA)	Decisión NEPA
FHWA, funcionario(s) con jurisdicción	Sección 4(f) de la Ley del Departamento de Transporte de Estados Unidos	Aprobación de la Sección 4(f)
Administración Federal de Aviación	Aviso de Construcción (14 CFR 77)	Aprobación
Cuerpo de Ingenieros del Ejército de EE.UU. (USACE)	Sección 404 de la Ley de Aguas Limpias	Permiso de la Sección 404
	Sección 14 de la Ley de Ríos y Puertos, 33 U.S.C 408 (Sección 408)	Aprobación de la Sección 408
	43 CFR 7.00; Protección de los recursos arqueológicos	Permiso federal para arqueólogos
Guardacostas de EE. UU.	Sección 9 de la Ley de Asignaciones para Ríos y Puertos	Permiso de puente de la Sección 9 de la Guardia Costera de EE. UU.
Servicio de Pesca y Vida Silvestre de EE. UU.	Sección 7 de la Ley de Especies Amenazadas	Aprobación de la Sección 7
	Ley del Tratado sobre Aves Migratorias	Revisión
	Ley de Protección del águila calva y real	Revisión
	Ley de Coordinación de Pesca y Vida Silvestre	Revisión
Servicio Nacional de Pesquerías Marinas, Oficina Regional de Pesquerías del Atlántico Mayor	Ley Magnuson-Stevens de conservación y gestión de la pesca	Determinación del hábitat esencial para los peces
	Sección 7 de la Ley de Especies en Peligro de Extinción	Aprobación de la sección 7
Agencia de Protección Medioambiental de EE. UU., MassDEP	Sistema Nacional de Eliminación de Vertidos Contaminantes (NPDES)	Permiso general de construcción
EPA y el Departamento de Protección		Permiso de Sistema Separado de alcantarillado

Ambiental de Massachusetts (MassDEP)		pluvial Municipal Pequeño de Massachusetts (MS4)
FHWA, Departamento de Transporte de Massachusetts (MassDOT), Oficial de Preservación Histórica del Estado de Massachusetts	Sección 106 de la Ley Nacional de Conservación Histórica	Memorandum de acuerdo
<b>Estado</b>		
Oficina Ejecutiva de Asuntos Energéticos y Medioambientales de Massachusetts	Ley de Política Medioambiental de Massachusetts (MEPA); 301 CMR 11.00	Aprobación de la MEPA
Comisión Histórica de Massachusetts	950 CMR 70.00 Comisión Histórica del Estado de Massachusetts	Permiso del arqueólogo estatal
Oficina de Gestión de la Zona Costera de Massachusetts	Ley de Gestión de la Zona Costera (CZM); 301 CMR 20.00	Revisión de Coherencia Federal CZM
(MassDEP)	Sección 401 de la Ley de Aguas Limpias de EE. UU.	Certificado de calidad del agua de la Sección 401
	Ley del Frente Marítimo Público de Massachusetts, Capítulo 91; 310 CMR 9.00	Licencia de vías navegables del capítulo 91
División de Pesca y Vida Silvestre de Massachusetts	Ley de Especies Amenazadas de Massachusetts (MESA); 321 CMR 10.00	MESA Permiso de conservación y gestión
Legislatura del Estado de Massachusetts	Artículo 97 de la Constitución de la Mancomunidad de Massachusetts	Artículo 97 Disposición de tierras
MassDOT	Aprobación de Acceso para carreteras y otras propiedades del Departamento de Transporte de Massachusetts; 700 CMR 13.00	Permiso de Acceso de Carreteras Estatales
<b>Local</b>		
Comisión de Conservación de Bourne	Ley de Protección de los Humedales de Massachusetts (MA WPA); 310 CMR 10.00	Orden de condiciones

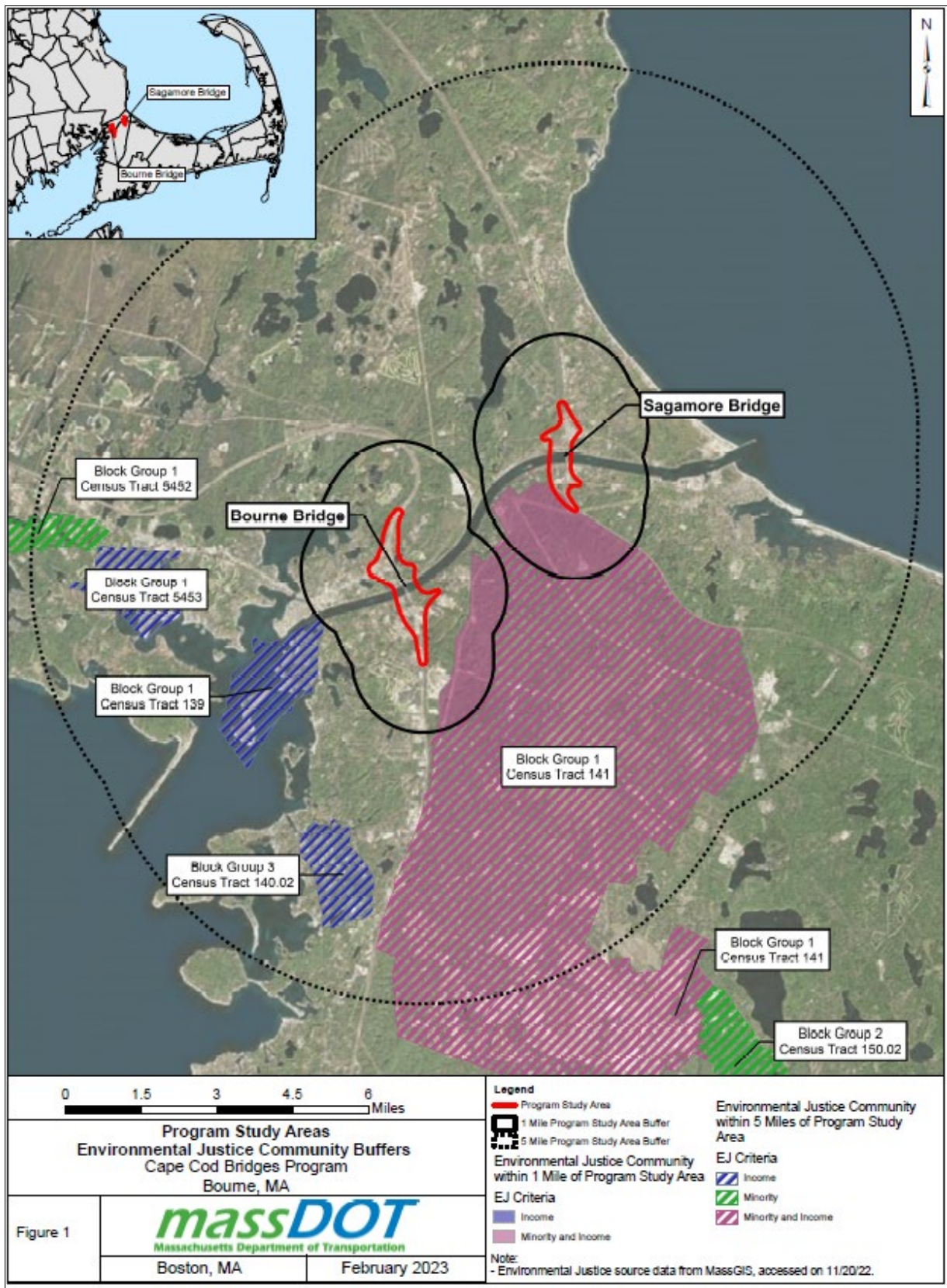
4. Identificar las poblaciones y características EJ (minorías, ingresos, aislamiento inglés) en un radio de 5 millas del lugar del proyecto (puede adjuntar un mapa que identifique el radio de 5 millas del [Visor del mapa de Justicia Medioambiental](#) (EJ, por sus siglas en inglés) en lugar de la descripción)

Las siguientes poblaciones EJ se encuentran en un radio de cinco millas de los puentes Bourne y Sagamore, como se muestra en la siguiente figura:

- Grupo de manzanas 1, Tramo censal 139, Bourne, Condado de Barnstable - Ingresos
- Grupo de manzanas 3, Tramo censal 140.02, Bourne, Condado de Barnstable - Ingresos

- Grupo de manzanas 1, Tramo censal 141, Bourne, Condado de Barnstable - Minoría e Ingresos
- Grupo de manzanas 1, Tramo censal 141, Sandwich, Condado de Barnstable - Minorías e Ingresos
- Grupo de manzanas 1, Tramo censal 5452, Wareham, Condado de Plymouth - Minoría
- Grupo de manzanas 1, Tramo censal 5453, Wareham, Condado de Plymouth -Ingresos

La zona EJ dentro del área del Programa Sagamore está asociada a la base conjunta “Joint Base Cape Cod” (Grupo de manzanas 1, Fracción 141). De los 22,000 acres de la propiedad, 15,000 acres no urbanizados comprenden la zona de entrenamiento del norte. Un total de 161 unidades residenciales proporcionan viviendas familiares de la Guardia Costera a casi 2,000 residentes en la zona sur del emplazamiento, situada a un mínimo de cinco millas de los puentes. Las zonas EJ en un radio de cinco millas del área del programa de estudio y al sur del Canal incluyen Gray Gables (Grupo de manzanas 1, Tramo censal 139) y Pocasset (Grupo de manzanas 3, Tramo censal 140.02) dentro de Bourne. Las áreas EJ dentro de las cinco millas del área del programa de estudio al norte del Canal en tierra firme incluyen East Wareham (Grupo de manzanas 1, Tramo censal 139) y Wareham (Grupo de manzanas 1, Tramo censal 5424).





5. Identificar cualquier municipio o zona censal que cumpla la definición de "criterios de Justicia Medioambiental de salud vulnerable" en la [herramienta de EJ DPH](#) situados total o parcialmente en un radio de 1 milla del emplazamiento del proyecto.

Los criterios de EJ de vulnerabilidad para la salud relativos a la exposición infantil al plomo y al bajo peso al nacer se evalúan a nivel de Tramo censal. Los criterios de EJ de vulnerabilidad para la salud relativos a la exposición infantil al plomo o al bajo peso al nacer no se cumplen en los Tramos censales situados en su totalidad, o en parte, en un radio de una milla de las zonas de estudio del Programa.

Los criterios de EJ de vulnerabilidad para la salud relativos a los infartos de miocardio (ataque al corazón) y el asma infantil se evalúan a nivel municipal para aquellos municipios situados en su totalidad, o en parte, en un radio de una milla de las áreas de estudio del programa (Bourne, Sandwich y Wareham). Los criterios de EJ de vulnerabilidad para la salud relativos a los infartos se cumple en el caso de Bourne. Los criterios de EJ de vulnerabilidad para la salud relativos tanto a los infartos de miocardio como al asma infantil se cumplen en el caso de Wareham. Véase la tabla siguiente para más detalles.

Municipio	Resultado en materia de salud	Rango de años	Tasa municipal	110 por ciento de la tasa estatal	Criterios EJ de salud vulnerables cumplidos por al menos un grupo de manzanas
Bourne	Infarto de miocardio	2013-2017	36.8	29.1	Sí
Wareham	Infarto de miocardio	2013-2017	43.5	29.1	Sí
Wareham	Asma infantil	2013-2017	98.1	91.4	Sí

6. Identificar los posibles impactos medioambientales y de salud pública a corto y largo plazo que puedan afectar a las poblaciones EJ y cualquier mitigación prevista

Partiendo del diseño conceptual, se prevé que se produzcan efectos en las propiedades adyacentes a los puentes Bourne y Sagamore y en las redes de carreteras de aproximación asociadas, que no están situadas dentro de las zonas EJ. Las poblaciones EJ de los pueblos de Gray Gables y Pocasset y de JBCC, más alejadas de las zonas de estudio del programa, podrían experimentar repercusiones, aunque en menor medida, porque es probable que viajen sobre el canal con regularidad para acceder al centro de Buzzard's Bay y a otros servicios comunitarios de Bourne, incluida la escuela primaria Bourne Elementary School.

MassDOT está evaluando las opciones de diseño del Programa que maximizarían la edificabilidad, reducirían la complejidad relativa a la disposición y la necesidad de estructuras temporales, y limitarían las repercusiones para la población en tránsito. En la medida de lo posible, la construcción del Programa incluiría el mantenimiento de dos carriles de tráfico en cada dirección en cada cruce y el mantenimiento de las conexiones con la red local de carreteras en lugares como las condiciones existentes. El Programa desplegaría zonas de trabajo inteligentes y dispositivos de gestión del tráfico en tiempo real para gestionar el tráfico y aumentar la seguridad de los trabajadores de la construcción y del público viajero. Se instalarían sensores, cámaras y señales de mensaje cambiante para proporcionar información

en tiempo real a los automovilistas, como tiempos de viaje, avisos de velocidad, información dinámica de incorporación, avisos de colas y avisos de camiones.

Las mejoras propuestas no activarían ningún Formulario de Notificación Ambiental (ENF) de la MEPA ni los niveles obligatorios de revisión del Informe de Impacto Ambiental (EIR) para la calidad del aire, los residuos peligrosos o las aguas residuales. Debido a la sustitución de los puentes de Bourne y Sagamore, elegibles para el Registro Nacional de Lugares Históricos (NRHP), el Programa provocaría un Efecto adverso en estos dos recursos históricos según la Sección 106 de la Ley Nacional de Preservación Histórica (NHPA). MassDOT está diseñando los reemplazos de los puentes para evitar y/o minimizar los impactos sobre el Distrito del Canal de Cape Cod, elegible para el NRHP.

A lo largo del diseño del Programa, MassDOT incorporaría medidas para evitar y minimizar las repercusiones en los recursos protegidos. En el caso de efectos inevitables, MassDOT proporcionaría mitigación en consulta con las agencias de recursos aplicables.

Se han evaluado los impactos sobre el derecho de paso basándose en el diseño conceptual. No se prevé que ninguna de las tomas potencialmente necesarias para el Programa se produzca dentro de zonas designadas EJ. A medida que avance el diseño y se confirmen las repercusiones, MassDOT propone aplicar el proceso de adquisición del derecho de paso de conformidad con la Ley de Políticas de Asistencia para la Reubicación y Adquisición de Bienes Inmuebles de 1970 (Ley Uniforme) (enmendada en 1987), y las Leyes Generales de Massachusetts, principalmente el Capítulo 79.

MassDOT se compromete a garantizar que ninguna persona sea excluida de la participación, se le nieguen los beneficios o sea objeto de cualquier otro tipo de discriminación, independientemente de su raza, color, origen nacional, sexo, edad y discapacidad. El Programa de Título VI/No discriminación de MassDOT para la FHWA supervisa el cumplimiento de los derechos civiles en la División de Carreteras de Massachusetts. MassDOT cuenta con un Programa de Operaciones Externas de Diversidad y Derechos Civiles para los proyectos financiados con fondos federales.

En coordinación con la FHWA y la MEPA, MassDOT ha elaborado un sólido Plan de Participación Pública (PIP) guiado por los principios de la divulgación integral, así como un Análisis Demográfico de la Comunidad y un Plan de Participación. Juntos, el PIP y el Plan de análisis demográfico y participación de la comunidad establecen medidas de eficacia que se utilizan para evaluar la divulgación y adaptarla según sea necesario, especialmente en comunidades históricamente desatendidas.

7. Identificar los beneficios del proyecto, incluidos los "Beneficios medioambientales" definidos en 301 CMR 11.02, que puedan mejorar las condiciones medioambientales o la salud pública de la población EJ

Las mejoras en los patrones de viaje a través de los puentes y la reducción de la congestión en los intercambiadores podrían servir para disminuir la sensación de separación entre las partes de Bourne situadas al norte y al sur del canal. Además, las mejoras en los enlaces aumentarían la conectividad este-oeste a ambos lados del canal. Se prevé que las mejoras de seguridad y diseño de las instalaciones para modos alternativos de desplazamiento y las nuevas porciones de instalaciones multimodales aumentarían los desplazamientos de peatones y ciclistas, lo que podría contribuir positivamente a los resultados sanitarios de la zona. Estos beneficios los experimentarían tanto las zonas EJ como las no EJ en general.

No se prevén efectos adversos para las geografías censales EJ dentro de las áreas de estudio del Programa. El Programa corregiría las deficiencias operativas existentes y mejoraría las condiciones de seguridad en los emplazamientos de los puentes y las intersecciones de aproximación, reduciendo así la congestión, mejorando los tiempos de viaje y manteniendo y mejorando la conectividad. El Programa reportaría beneficios sustanciales a los viajeros, residentes y visitantes de la localidad de Bourne y de Cape Cod. Teniendo en cuenta los beneficios generales en materia de transporte y calidad de vida para la localidad y la región inmediatas, no se prevén impactos desproporcionadamente elevados y adversos para las poblaciones EJ.

8. Describir cómo los miembros de la comunidad pueden solicitar una reunión para discutir el proyecto y cómo pueden solicitar servicios de interpretación oral en la reunión. Especifique cómo solicitar otras adaptaciones, incluidas reuniones fuera del horario laboral y en lugares cercanos al transporte público

Para obtener información general, visite la página web del proyecto: [www.mass.gov/cape-bridges](http://www.mass.gov/cape-bridges). Para dejar un comentario en línea, visite: [https://pima.massdotpi.com/public/comment/project-comment-dynamic?project\\_id=13868](https://pima.massdotpi.com/public/comment/project-comment-dynamic?project_id=13868). Las consultas sobre proyectos, incluidas las solicitudes de reuniones, pueden enviarse por correo electrónico a: [MassDOTMajorProjects@dot.state.ma.us](mailto:MassDOTMajorProjects@dot.state.ma.us). Cualquier comentario por escrito sobre el proyecto propuesto puede remitirse a:

*Carrie Lavalley, P.E. Chief Engineer  
Massachusetts Department of Transportation  
Attn: Project Management, Project File No. 608020  
10 Park Plaza  
Boston, MA 02116*

MassDOT proporciona adaptaciones razonables y/o asistencia lingüística gratuita previa solicitud, según proceda. Para solicitar adaptaciones o asistencia lingüística, póngase en contacto con el Jefe de Diversidad y Derechos Civiles de MassDOT por teléfono (857-468-8580), TTD/TTY al (857) 266-0603, fax (857) 368-0602, o correo electrónico [MassDOT.CivilRights@dot.state.ma.us](mailto:MassDOT.CivilRights@dot.state.ma.us). Las solicitudes deben hacerse lo antes posible antes de la reunión, y para los servicios más difíciles de organizar, incluidos los de lengua de signos, CART o traducción o interpretación de idiomas, las solicitudes deben hacerse al menos diez días hábiles antes de la reunión.

## **Formulário de avaliação de Justiça Ambiental**

Nome do projeto	Programa de Pontes em Cape Cod (Cape Cod Bridges Program)
Data prevista de protocolo do MEPA	05/01/2023
Nome do proponente	Departamento de Transporte de Massachusetts (MassDOT) – Divisão de rodovias
Informações de contato	Bryan Cordeiro, Gerente do Programa de Pontes em Cape Cod do MassDOT, bryan.cordeiro@state.ma.us
Site público do projeto ou outro local físico onde os materiais do projeto podem ser obtidos	<a href="https://www.mass.gov/cape-bridges">https://www.mass.gov/cape-bridges</a>
Município e código postal do projeto	Bourne, MA 02532
Tipo de projeto* (liste todas as opções que se apliquem)	Transporte – Rodovias/tráfego, Transporte – trilhas, Lazer
O local do projeto está dentro de uma planície de inundação de 100 anos mapeada pela FEMA?	Sim
Emissões estimadas de GEE de espaços condicionados ( <a href="#">clique aqui para acessar a ferramenta de estimativa de GEE</a> )	N/D

### Descrição do projeto

1. Forneça uma breve descrição do projeto, incluindo o tamanho geral do local do projeto e a área dos prédios e estruturas propostos, se conhecidos.

Em coordenação com a Administração Rodoviária Federal (FHWA) e o Distrito do Corpo de Engenheiros do Exército dos EUA (USACE) na Nova Inglaterra, o Departamento de Transporte de Massachusetts (MassDOT) está propondo substituir as pontes rodoviárias de Bourne e Sagamore, assim como melhorar as redes viárias que se aproximam em ambos os lados do Canal de Cape Cod. As áreas de estudo do Programa incluem as áreas das pontes existentes e as duas interseções de acesso à rodovia para cada cruzamento. O objetivo do Programa de Pontes em Cape Cod (o Programa) é melhorar a mobilidade e a acessibilidade através do canal entre Cape Cod e Massachusetts continental para todos os usuários das rodovias e atender às crescentes necessidades de manutenção e obsolescência funcional das pontes rodoviárias antiquadas do Canal de Cape Cod. O Programa melhorará as operações de trânsito e as acomodações multimodais para facilitar a movimentação confiável e eficiente de pessoas, bens e serviços através do Canal de Cape Cod.

O Programa é necessário para abordar os problemas existentes relacionados ao transporte e às condições insatisfatórias das pontes existentes, incluindo: a obsolescência funcional das pontes; as condições estruturais insatisfatórias das pontes e sua constante necessidade de manutenção; e as condições de tráfego e congestionamento nos períodos de pico.

2. Liste os limites de revisão previstos pela MEPA (Lei da Política Ambiental de Massachusetts (301 CMR 11.03))

- 301 CMR 11.03(1)(a)1. Alteração direta de 202.343 m<sup>2</sup> (50 acres) ou mais de terreno
- 301 CMR 11.03(1)(a)2. Criação de cerca de 40.469 m<sup>2</sup> (10 acres) ou mais de área impermeável
- 301 CMR 11.03(6)(b)1.b. Alargamento de uma rodovia existente por 1,2 m (4 pés) ou mais por cerca de 0,8 km (1/2 milha) ou mais.
- 301 CMR 11.03(6)(b)2.a. A construção/alargamento de uma rodovia ou seu direito de passagem modificará a margem ou terreno localizado a mais de 3 m (10 pés) da rodovia existente por cerca de 0,8 km (1/2 milha) ou mais.
- 301 CMR 11.03(6)(b)2.b. A construção/alargamento de uma rodovia ou seu direito de passagem que cortará cinco ou mais árvores de sombra públicas vivas de 35,5 cm (14 polegadas) ou mais em diâmetro à altura do peito.

3. Liste todas as autorizações estaduais, locais e federais previstas necessárias para o projeto

Entidade	Regulamentação	Autorização/Aprovação regulatória
<b>Federal</b>		
Administração Rodoviária Federal (FHWA)	Lei da Política Ambiental Nacional (NEPA)	Decisão da NEPA
FHWA, Oficial(is) com jurisdição	Seção 4(f) da Lei do Departamento de Transporte dos Estados Unidos	Aprovação da Seção 4(f)
Administração Federal da Aviação (FAA)	Aviso de Construção (14 CRF 77)	Aprovação
Corpo de Engenheiros do Exército dos EUA (USACE)	Seção 404 da Lei da Água Limpa	Autorização da Seção 404
	Seção 14 da Lei de Rios e Portos, 33 U.S.C 408 (Seção 408)	Aprovação da Seção 408
	43 CFR 7.00; Proteção de Recursos Arqueológicos	Autorização do Arqueólogo Federal
Guarda Costeira dos EUA	Seção 9 da Lei de Apropriações de Rios e Portos	Seção 9 da Guarda Costeira dos EUA Autorização de Pontes
Serviço de Pesca e Vida Selvagem dos EUA	Seção 7 da Lei de Espécies Ameaçadas de Extinção	Aprovação da Seção 7
	Lei do Tratado de Aves Migratórias	Revisão
	Lei de Proteção da Águia Careca e Dourada	Revisão
	Lei de Coordenação de Peixes e Vida Selvagem	Revisão
Serviço Nacional de Pesca Marinha, Direção Regional de Pescas do Oceano Atlântico	Lei de Gestão e Conservação da Pesca de Magnuson-Stevens	Determinação de Habitats de Peixes Essenciais
	Sessão 7 da Lei de Espécies Ameaçadas	Aprovação da Seção 7
Agência de Proteção Ambiental dos EUA	Sistema Nacional de Eliminação de Descarga de Poluição (NPDES)	Autorização Geral para Construção
Agência de Proteção Ambiental dos EUA e		Autorização Pequenos Sistemas Municipais

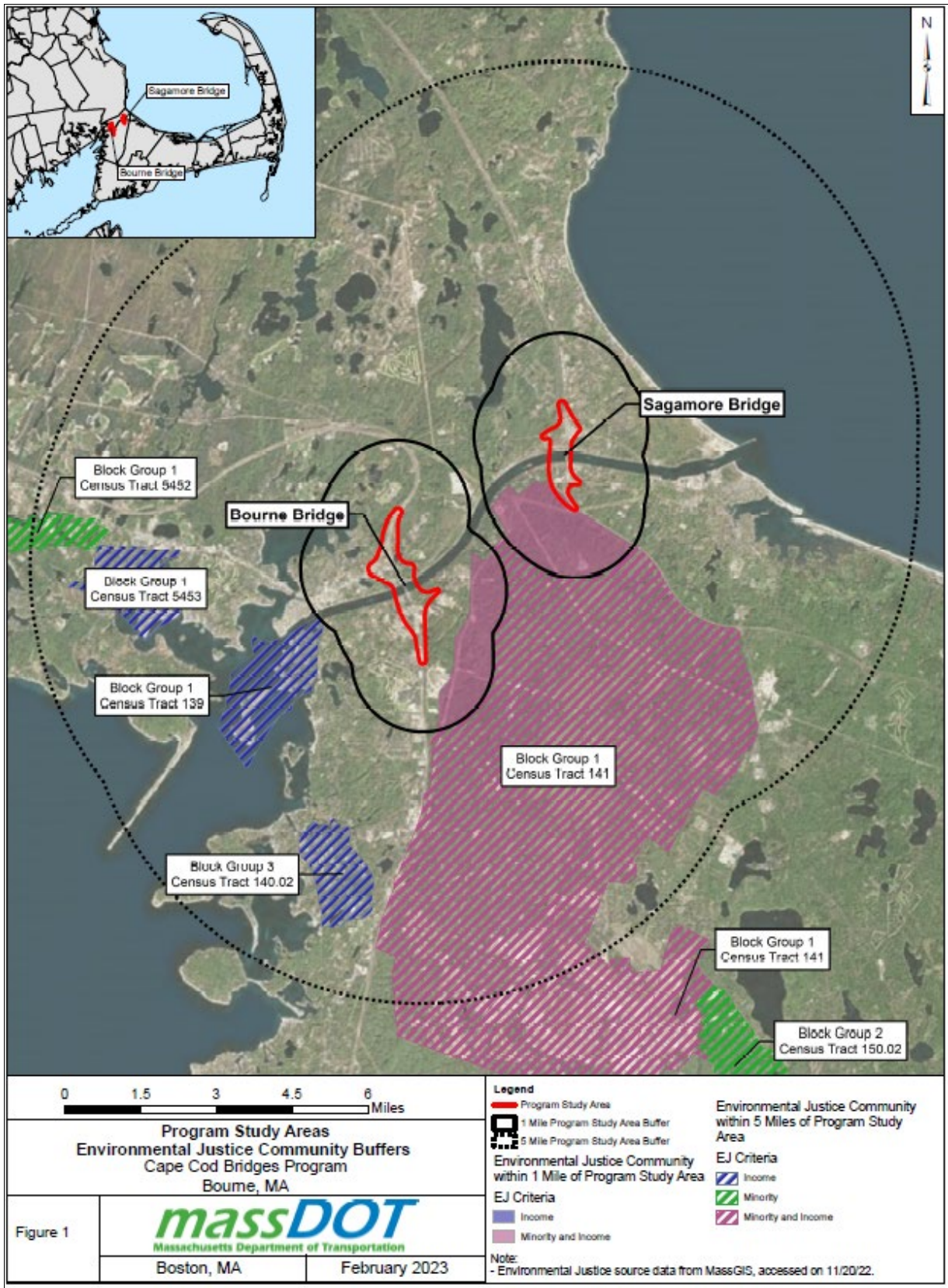
Departamento de Proteção Ambiental de Massachusetts		Separados de Esgoto Pluvial de Massachusetts
FHWA, Departamento de Transporte de Massachusetts (MassDOT), Gabinete de Preservação Histórica do Estado de Massachusetts	Seção 106 da Lei de Preservação Histórica Nacional	Memorando de acordo
<b>Estadual</b>		
Gabinete Executivo de Questões Ambientais e de Energia de Massachusetts	Lei da Política Ambiental de Massachusetts (MEPA); 301 CMR 11.00	Aprovação da MEPA
Comissão Histórica de Massachusetts	950 CMR 70.00 Comissão Histórica do Estado de Massachusetts	Autorização do Arqueólogo Estadual
Gabinete de Massachusetts de Gestão da Zona Costeira	Lei de Gestão da Zona Costeira (CZM); 301 CMR 20.00	Revisão de Consistência Federal da CZM
Departamento de Proteção Ambiental de Massachusetts (MassDEP)	Seção 401 da Lei da Água Limpa dos EUA	Seção 401 do Certificado de Qualidade da Água
	Lei da Orla Pública de Massachusetts, Capítulo 91; 310 CMR 9.00	Capítulo 91, Licença de Vias Navegáveis
Divisão de Pesca e Vida Selvagem de Massachusetts	Lei de Espécies Ameaçadas de Extinção de Massachusetts (MESA); 321 CMR 10.00	Autorização para gestão e conservação da MESA
Legislatura Estadual de Massachusetts	Artigo 97 da Constituição da Commonwealth de Massachusetts	Artigo 97 da Disposição de terra
Departamento de Transporte de Massachusetts (MassDOT)	Aprovação de acesso às rodovias e outras propriedades do Departamento de Transporte de Massachusetts; 700 CMR 13.00	Autorização de Acesso à Rodovia Estadual
<b>Local</b>		
Comissão de Conservação de Bourne	Lei de Proteção dos Alagados de Massachusetts (MA WPA); 310 CMR 10.00	Ordem de Condições

4. Identifique as populações e características de Justiça Ambiental (minorias, renda, isolamento pela língua inglesa) dentro de 8 km (5 milhas) do local do projeto (pode ser anexado um mapa identificando um raio de 8 km (5 milhas) a partir do [Visualizador de mapas de Justiça Ambiental](#), em substituição à descrição por escrito)

As seguintes populações de Justiça Ambiental estão localizadas dentro de 8 km (5 milhas) das pontes de Bourne e Sagamore, conforme demonstrado na imagem abaixo:

- Grupo do Bloco 1, Setor Censitário 139, Bourne, Condado de Barnstable – Renda
- Grupo do Bloco 3, Setor Censitário 140.02, Bourne, Condado de Barnstable – Renda
- Grupo do Bloco 1, Setor Censitário 141, Bourne, Condado de Barnstable – Minoria e renda
- Grupo do Bloco 1, Setor Censitário 141, Sandwich, Condado de Barnstable – Minoria e renda
- Grupo do Bloco 1, Setor Censitário 5452, Wareham, Condado de Plymouth – Minoria
- Grupo do Bloco 1, Setor Censitário 5453, Wareham, Condado de Plymouth – Renda

A área de Justiça Ambiental dentro da área do Programa de Sagamore está associada à Base Conjunta de Cape Cod (Grupo do Bloco 1, Setor Censitário 141). Da propriedade de 89 km<sup>2</sup> (22.000 acres), cerca de 60 km<sup>2</sup> (15.000 acres) não desenvolvidos compreendem a área de treinamento ao norte. Um total de 161 unidades residenciais provê moradia às famílias da Guarda Costeira para quase 2.000 residentes na área ao sul do local situado a, pelo menos, 8 km (5 milhas) das Pontes. As áreas de Justiça Ambiental dentro de 8 km (5 milhas) da Área de Estudo do Programa, a sul do Canal, incluem Gray Gables (Grupo do Bloco 1, Setor Censitário 139) e Pocasset (Grupo do Bloco 3, Setor Censitário 140.02), dentro de Bourne. As áreas de Justiça Ambiental dentro de 8 km (5 milhas) Da Área de Estudo do Programa a norte do Canal no continente incluem East Wareham (Grupo do Bloco 1, Setor Censitário 139) e Wareham (Grupo do Bloco 1, Setor Censitário 5424).





5. Identifique qualquer município ou setor censitário que atenda à definição de “critérios de saúde de vulneráveis para populações de Justiça Ambiental” na [Ferramenta de Justiça Ambiental DPH](#), localizado, total ou parcialmente, dentro do raio de 1,6 km (1 milha) do local do projeto

Os critérios de saúde de vulneráveis para populações de Justiça Ambiental, quanto à exposição infantil a chumbo e ao baixo peso no nascimento, são avaliados a nível de setor censitário. Os critérios de saúde de vulneráveis para populações de Justiça Ambiental, quanto à exposição infantil a chumbo ou ao baixo peso no nascimento, não são observados para setores censitários localizados, total ou parcialmente, dentro de 1,6 km (1 milha) das áreas de estudo do Programa.

Os critérios de saúde de vulneráveis para populações de Justiça Ambiental, quanto a ataques cardíacos e asma infantil, são avaliados a nível municipal para aqueles municípios localizados, total ou parcialmente, dentro de 1,6 km (1 milha) das áreas de estudo do Programa (Bourne, Sandwich e Wareham). O critério de saúde de vulneráveis para populações de Justiça Ambiental, quanto a ataques cardíacos, é observado para Bourne. O critério de saúde de vulneráveis para populações de Justiça Ambiental, quanto a ataques cardíacos e asma infantil, é observado para Wareham. Veja a tabela abaixo para obter mais detalhes.

Município	Efeitos na saúde	Intervalo de anos	Taxa do município	110 % da taxa estadual	Critérios de saúde de vulneráveis para populações de Justiça Ambiental atendidas por, pelo menos, um grupo do bloco
Bourne	Ataque cardíaco	2013-2017	36,8	29,1	Sim
Wareham	Ataque cardíaco	2013-2017	43,5	29,1	Sim
Wareham	Asma infantil	2013-2017	98,1	91,4	Sim

6. Identifique potenciais impactos ambientais e de saúde pública de curto e longo prazo que podem afetar as populações de Justiça Ambiental e qualquer mitigação prevista

Com base no projeto conceitual, os impactos são concebidos para ocorrer em propriedades adjacentes às pontes de Bourne e Sagamore e às redes viárias de acesso associadas, que não estejam localizadas nas áreas de Justiça Ambiental. As populações de Justiça Ambiental nas comunidades de Gray Gables e Pocasset e JBCC, mais distantes das áreas de estudo do Programa, poderiam sofrer impactos, embora em menor grau, porque provavelmente transitam pelo canal regularmente para acessar o centro da cidade de Buzzard's Bay e outras amenidades da comunidade em Bourne, incluindo a escola Bourne Elementary School.

O MassDOT está avaliando as opções de concepção do Programa que maximizariam a construtibilidade, reduziriam a complexidade relativa à preparação e a necessidade de estruturas temporárias e limitariam os impactos sobre o público em trânsito. Na medida do

possível, a execução do Programa incluiria a manutenção de duas faixas de tráfego em cada direção em cada cruzamento e a manutenção de conexões com a rede viária local em locais, como condições existentes. O Programa implementaria Zonas de Trabalho Inteligente e dispositivos de gerenciamento de tráfego em tempo real para gerenciar o tráfego e aumentar a segurança dos trabalhadores da construção e do público em trânsito. Sensores, câmeras e sinais de mensagem variáveis seriam implementados para fornecer informações, em tempo real, aos motoristas, como tempos de viagem, avisos de velocidade, feedback dinâmico de confluências, avisos de filas e avisos de caminhões.

As melhorias propostas não gerariam nenhum Formulário de Notificação Ambiental (ENF) da MEPA ou limites de revisão obrigatórios do Relatório de Impacto Ambiental (EIR) para a qualidade do ar, resíduos perigosos ou águas residuais. Devido à substituição das pontes de Bourne e Sagamore, qualificadas pelo Registro Nacional de Lugares Históricos (NRHP), o Programa resultaria em um Efeito Adverso para esses dois recursos históricos sob a Seção 106 da Lei Nacional de Preservação Histórica (NHPA). O MassDOT está projetando as substituições das pontes de forma a evitar e/ou minimizar os impactos no Distrito do Canal de Cape Cod, qualificado pelo NRHP.

Ao longo da concepção do Programa, o MassDOT incorporaria medidas para evitar e minimizar os impactos aos recursos protegidos. Para impactos inevitáveis, o MassDOT forneceria mitigação em consulta com as agências de recursos aplicáveis.

Os impactos sobre o direito de passagem têm sido avaliados com base no projeto conceitual. Nenhuma das apropriações potencialmente necessárias para o Programa está prevista para ocorrer dentro das áreas designadas de Justiça Ambiental. À medida que os avanços e impactos do projeto sejam confirmados, o MassDOT propõe a implementação do processo de aquisição do direito de passagem, em conformidade com a Lei das Políticas de Assistência à Relocação e Aquisição de Imóveis de 1970 (Lei Uniforme) (alterada em 1987) e as Leis Gerais de Massachusetts, principalmente Capítulo 79.

O MassDOT está empenhado em garantir que nenhuma pessoa seja excluída de participação, tenha benefícios negados ou, de outra forma, seja sujeita à discriminação, independentemente de raça, cor, nacionalidade, sexo, idade e deficiência. O Programa de Título VI/Não Discriminação do MassDOT para a FHWA supervisiona o cumprimento dos direitos civis na Divisão de Rodovias de Massachusetts. O MassDOT tem um Programa de Operações Externas de Direitos Civis e Diversidade para projetos financiados pelo governo federal.

Em coordenação com a FHWA e a MEPA, o MassDOT apresentou um sólido Plano de Envolvimento Público (PIP), orientado pelos princípios de divulgação abrangente, assim como uma Análise Demográfica da Comunidade e Plano de Engajamento. Juntos, o PIP e o Plano de Envolvimento e Análise Demográfica da Comunidade estabelecem medidas de eficácia que são usadas para avaliar o alcance e fazer adaptações, conforme seja necessário, especialmente em comunidades historicamente carentes.

7. Identifique os benefícios do projeto, incluindo os “Benefícios Ambientais”, conforme definido em 301 CMR 11.02, que podem melhorar as condições ambientais ou a saúde pública da população de Justiça Ambiental

As melhorias nos padrões de trânsito nas pontes e a redução do congestionamento nas interseções poderiam servir para diminuir a sensação de separação entre as partes de Bourne localizadas ao norte e ao sul do canal. Além disso, as melhorias nas interseções aumentariam a conectividade Leste-Oeste em ambos os lados do canal. É previsto que as

atualizações de segurança e design às instalações para modos alternativos de trânsito e novas partes das instalações multimodais aumentem o trânsito de pedestres e ciclistas, o que poderia contribuir positivamente para efeitos na saúde da área. Esses benefícios seriam experimentados tanto por áreas de Justiça Ambiental, como de não Justiça Ambiental em geral.

Não são previstos impactos adversos nas geografias censitárias de Justiça Ambiental dentro das áreas de estudo do Programa. O Programa corrigiria as deficiências operacionais existentes e melhoraria as condições de segurança nos locais das pontes e nas interseções de acesso, reduzindo assim o congestionamento, melhorando os tempos de viagem e mantendo e aprimorando a conectividade. O Programa resultaria em benefícios substanciais para usuários de transportes, residentes e visitantes à cidade de Bourne e Cape Cod. Considerando-se os benefícios de qualidade de vida e transporte em geral para o local e região imediatos, não são previstos impactos desproporcionalmente altos e adversos para as populações de Justiça Ambiental.

8. Descreva como a comunidade pode organizar uma reunião para discutir o projeto e como a comunidade pode solicitar serviços de interpretação de linguagem verbal na reunião. Especifique como solicitar outras acomodações, inclusive reuniões fora do horário comercial e em locais próximos a transportes públicos.

Para informações gerais, visite o site do projeto: [www.mass.gov/cape-bridges](http://www.mass.gov/cape-bridges). Para deixar um comentário online, visite: [https://pima.massdotpi.com/public/comment/project-comment-dynamic?project\\_id=13868](https://pima.massdotpi.com/public/comment/project-comment-dynamic?project_id=13868). Perguntas sobre o projeto, inclusive solicitações para reuniões, podem ser enviadas por e-mail para: [MassDOTMajorProjects@dot.state.ma.us](mailto:MassDOTMajorProjects@dot.state.ma.us). Quaisquer comunicações, por escrito, referentes ao empreendimento proposto, podem ser enviadas para:

*Carrie Lavallee, P.E. Chief Engineer  
Massachusetts Department of Transportation  
Attn: Project Management, Project File No. 608020  
10 Park Plaza  
Boston, MA 02116*

O MassDOT oferece, gratuitamente, acomodações razoáveis e/ou assistência a idioma, mediante solicitação, conforme apropriado. Para solicitar acomodação ou assistência a idioma, entre em contato com o Diretor de Diversidade e Direitos Civis do MassDOT pelo telefone (857-468-8580), TTD/TTY em (857) 266-0603, por fax em (857) 368-0602 ou por e-mail para [MassDOT.CivilRights@dot.state.ma.us](mailto:MassDOT.CivilRights@dot.state.ma.us). As solicitações devem ser feitas o mais rápido possível antes da reunião e, para serviços mais difíceis de serem arranjados, inclusive linguagem gestual, CART ou tradução ou interpretação de idiomas, as solicitações devem ser feitas, pelo menos, dez dias úteis antes da reunião.

## 9.2 Cape Cod Bridges Program Public Involvement Plan, March 2023



Massachusetts Department of Transportation

# Public Involvement Plan

Cape Cod Bridges Program

March 2023



## Table of Contents

Introduction:	2
Background:	2
Program Description:	2
Current Program Schedule:	3
Purpose:	4
Goals:	4
Strategies:	5
Stakeholder Engagement	5
Advisory Group	6
Meetings	6
1. Advisory Group Meetings	6
2. Legislative Briefings	7
3. Targeted Stakeholder Meetings	7
4. Public Meetings	8
5. Pop-up Events	9
6. Open House	9
Program Website	10
1. Online Comment Tool	10
2. Program Subscription Link	10
3. Public Meeting Recordings and Information	11
4. Project Materials	11
5. Survey	11
Program Communications	11
Branding	12
1. Messaging	12
2. Social Media	12
Environmental Justice (EJ), Title VI, and Other Demographics	12
EJ Update	15
Public Involvement Tasks	16
Measures of Effectiveness:	18
Challenges and Solutions	19
National Environmental Policy Act (NEPA) Process	20
Section 106 of the National Historic Preservation Act	22
Section 4(f) of the Department of Transportation Act	23
Conclusion	23

## Introduction:

This Public Involvement Plan (PIP) for the Massachusetts Department of Transportation (MassDOT) Cape Cod Bridges Program (CCBP) details the progress made in engaging and informing the public, as well as the latest available outreach and Program schedule, and the comprehensive, inclusive, and effective strategies which will continued to be used to solicit feedback from key stakeholders and the local community. This Program includes the replacement of the Bourne and Sagamore bridges, as well as improvements to the approach roadway networks to address the multimodal deficiencies within the Cape Cod Canal area.

## Background:

MassDOT initiated the Cape Cod Canal Transportation Study in 2014 to understand the existing and future multimodal transportation deficiencies and needs around the Cape Cod Canal area. The goal of the Study was to “improve transportation mobility and accessibility in the Cape Cod Canal Area and to provide reliable year-round connectivity over the Canal and between the Sagamore and Bourne bridges.”<sup>1</sup> A [Final Report](#) was released in 2019 after an extensive public involvement process, which included Advisory Group meetings, public information meetings, and opportunities for public comment. The Final Report outlined specific recommendations for improving multimodal connectivity and reliability across the Canal region to protect quality of life for Cape Cod residents, workers, and visitors.

MassDOT also partnered with the United States Army Corps of Engineers (USACE) for the USACE Major Rehabilitation Evaluation Study, which resulted in a Draft and Final Major Rehabilitation Evaluation Report (MRER). The Study evaluated whether a major rehabilitation or replacement of one or both Cape Cod Canal bridges would provide the most reliable and fiscally responsible solution to address the current structurally deficient bridges. The public was able to provide input on the Study at multiple public meetings held in 2018 and 2019 and during the formal public comment period for the Draft MRER in the Fall of 2019 in compliance with USACE implementing NEPA regulations. All public comments received were incorporated into the [Final MRER](#) published in March of 2020. On April 3, 2020, the official decision to replace the current Bourne and Sagamore Bridges with two new replacement bridges was announced by the USACE and Assistant Secretary of the Army for Civil Works.

On July 7, 2020, a [Memorandum of Understanding](#) (MOU) was executed between MassDOT and the USACE in regard to the replacement of the Cape Cod Canal bridges. Under this MOU, the USACE will continue to own, operate, and maintain the existing Bourne and Sagamore Bridges until the new bridges are placed into service. MassDOT will lead the design and construction efforts with responsibility to own, operate and maintain the two new bridges.

## Program Description:

The MassDOT Cape Cod Bridges Program is a regional effort that includes the replacement of the Bourne and Sagamore Bridges as well as improvements to the approach roadway network. The Program team will utilize the information collected, lessons learned, and recommendations from the MassDOT Cape Cod Canal Transportation Study and USACE MRER to make informed decisions on the Program structure, approach, and design alternatives.

---

<sup>1</sup> <https://www.mass.gov/cape-cod-canal-transportation-study>

The Program team referenced throughout this Plan is the key decision-making body regarding Program development and public involvement efforts. The team includes representatives from the following groups:

- MassDOT
  - Program Managers
  - Communications Office
  - Legislative Affairs Office
  - Highway Administrator's Office
  - District 5 Office
  - Environmental Services
- Federal Highway Administration
- U.S. Army Corps of Engineers
- Consultant design and public involvement staff

### Current Program Schedule:

The Program will occur in multiple phases due to the complexity of the area and work required to make substantial improvements to traffic and multimodal accommodations. Phase 1, completed as of December 2022, included the following:

- Data collection - including environmental conditions and traffic patterns
- Initiation of public outreach and involvement efforts

Phase 1 also included three rounds of public engagement - in June 2021, November 2021, and November 2022 respectively. Each of these rounds included public meetings and stakeholder briefings and outreach, which is described in further detail below.

The Program is currently in Phase 2 which includes developing and refining bridge and roadway options based on public feedback received during past, ongoing, and upcoming rounds of public engagement. This phase has so far included one round of public engagement - the fourth round of the Program - which was held in January 2023.

Within the next six months, the Program is expected to transition to Phase 3, which includes identifying preferred options, beginning the environmental documentation process, as well as design development.

Additionally, the schedule assumes the following public involvement activities will take place through the next several months:

- Spring 2023: Round 5A Bourne focused public meetings to provide update on bridge types, range of alternatives, and interchanges paired with mainline, as well as a grant update
- Spring 2023: Round 5B Sagamore focused public meetings to provide update on bridge types, range of alternatives, and interchanges paired with mainline, as well as a grant update
- Spring 2023: File Pre-NEPA - Initiation Package with FHWA, which will include:
  - Draft Range of Alternatives
  - Agency Involvement Plan
  - Extent of Analysis for Resources (Methodologies)
- Spring 2023: Convene Advisory Group



- Spring 2023: File MEPA ENF
- Spring 2023: MEPA public meetings to provide update on bridge types, grants, range of alternatives, as well as interchanges paired with mainline
- Summer 2023: MEPA Issues EIR Scope
- Summer/Fall 2023: Engage Cooperating Agencies to seek comments and concurrence on Pre-NEPA Initiation Package
- Summer/Fall 2023: Continue to engage Advisory Group

The subsequent phases of the Program include:

- Phase 4: MassDOT completes preliminary design and environmental review/permitting.
- Phase 5: Construction underway
- Delivery: The Cape Cod Bridges Program is completed.

## Purpose:

The purpose of this PIP is to guide the public involvement process during all phases of Program development in compliance with the state and federal guidance and policies on public involvement.

For example, Part 771 of Title 23 of the CFR, which lays out the policies and procedures for implementing the National Environmental Policy Act, states that “public involvement and a systematic interdisciplinary approach be essential parts of the development process for proposed actions.” This PIP recognizes this critical need and therefore places community engagement at the forefront of program design activities.

Due to the regional importance of access to Cape Cod, this transformational Program necessitates an innovative and collaborative approach to public involvement. It is imperative that the public involvement process is transparent and inclusive, allowing for two-way communication across all demographics and geographies. Having a robust PIP ensures MassDOT is utilizing effective communication strategies to achieve consensus amongst diverse populations that help inform Program development. Consistent messaging throughout design and construction is critical to the overall success of the Program.

It is important to note that the PIP is a living document which is continuously updated depending upon its effectiveness and Program progress. The success of the Program and the PIP with each round of public engagement will help determine any subsequent updates and specific measures and tools that will be used in accordance with the outreach strategies.

## Goals:

The goals of this PIP include:

1. Continue to effectively inform and engage a broad base of geographically and demographically diverse stakeholders across Cape Cod and the region about this Program
2. Ensure that the public process continues to be inclusive and accessible and provides ample opportunity to engage with the Program team, provide feedback, ask questions, and attend public meetings for all those who choose to participate
3. Maintain effective online and in person communication with stakeholders in Cape Cod and across the region
4. Allow the public opportunity to continue to inform the project development process

5. Remain responsive to stakeholder comments, inquiries, and needs throughout the entirety of the Program
6. Maintain and update online resources and materials for the public to learn about the status of the Program and ensure materials are accessible for all populations
7. Continuously adapt outreach strategies, messaging, and communication tactics based on public feedback, and sentiment
8. Comply with the following federal and state requirements:
  - 23 USC 139. Efficient Environmental Reviews for Project Decision Making
  - Title VI of the Civil Rights Act of 1964, as codified at 42 USC 2000d(1-7)
  - Council on Environmental Quality (CEQ) National Environmental Policy Act (NEPA) regulations, as codified at 40 CFR 1500 - 1508.
  - Section 106 of the National Historic Preservation Act at 16 USC 470 and 36 CFR 800 procedures for Implementation
  - Executive Order 12898: Federal Actions to Address Environmental Justice in Minority Populations and Low-Income Populations
  - Section 4(f) of the U.S. Department of Transportation Act as codified at 23 USC 138 and 49 USC 303; de minimis impact determinations under 23 CFR 774.5(b)
  - Massachusetts Environmental Policy Act (MEPA) at M.G.L c.30, ss. 61 - 62I and implementing regulations at 301 CMR 11.00
  - The Uniform Relocation Assistance and Real Property Acquisition Policies Act of 1970 (Uniform Act)

## Strategies

This PIP has been developed and refined as the Program continues to evolve and progress. The strategies described in the next section outline the various methods that are being deployed to engage with the public in an inclusive, transparent, and accessible manner.

Further details on the utilization of these strategies and related deliverables are available further in this document in the “Public Involvement Tasks” section.

## Stakeholder Engagement

A stakeholder database has been developed to disseminate Program information throughout Program development. The Program database drew from the Cape Cod Canal Transportation Study and MRER stakeholder lists. Messaging to the database includes schedule updates, public meeting invites and reminders, Program milestones, and public engagement opportunities.

This database has grown throughout the Program as stakeholders subscribe to updates, submit comments, and attend virtual or in-person meetings. The database is being managed and updated on a regular basis through MassDOT’s Public Involvement Management Application (PIMA).

The database includes over 3,000 stakeholders which include, but are not limited to:

- Local, State, and Congressional Officials
- Abutters
- Residents and local property owners
- Businesses
- Federal, state, and local environmental agencies
- Planning Commissions

- Chambers of Commerce
- Neighborhood associations
- Transit authorities
- Transportation groups
- Community/advocacy groups
- Bike and pedestrian groups
- Tourism sites/groups
- Hospitality groups
- Emergency services
- Education institutions
- Recreation areas
- Tribal councils
- Council on Aging
- Senior Centers
- Members of the public

Communications are distributed regularly via email to the stakeholder database. Specific communications methods and topics are described in the “Program Communications” section below.

### Advisory Group

The Program will establish a Advisory Group to allow for increased engagement with key stakeholder within the Program area, and learn of community feedback, needs and concerns in a focused setting.

Advisory Group members will represent a variety of stakeholder types including, but not limited to, local and elected officials, planning commissions, emergency services representatives, economic development representatives, and chambers of commerce.

The Advisory Group will provide feedback and input on topics such as design alternatives, community and environmental impacts, and the construction schedule. Feedback, concerns, and questions brought up during Advisory Group discussions will be used by the Program team to help make informed decisions throughout Program development. Consensus by the Advisory Group will be sought but will not be required in order to move forward with the Program.

### Meetings

Regular outreach meetings with the public and stakeholder groups and organizations have taken place during all four previous rounds of public engagement and will continue throughout the duration of the Program.

As of March 3, 2023, all meetings have taken place virtually, which has allowed for increasingly high levels of attendance and engagement by stakeholders throughout the Program area and the region.

The types of meetings for this Program have and will continue to include:

#### 1. Advisory Group Meetings

Upon the establishment of the Advisory Group, meetings will be held regularly and in accordance with key milestones and Program development.

The Program team will plan and host each of the Advisory Group Meetings. Materials utilized at meetings will include PowerPoint presentations, maps, and graphics, and meeting times will be scheduled based upon member availability. In addition to a formal presentation by the Program team, Advisory Group meetings will include ample opportunity for questions, comments, and meaningful discussions amongst all attendees.

Members from the Program team will also provide technical assistance with meeting registrations and will be available to help moderate discussions and take notes at each meeting. Meeting notes will then be distributed to the Program team and Advisory Group. Meeting materials, including presentations, meeting notes, and attendee lists will also be made available on the Program's website page approximately three weeks after each meeting.

## 2. Legislative Briefings

This Program includes legislative briefings with State and Federal officials to provide Program updates and the opportunity to meet with the Program team before information is distributed to the broader public.

Legislative briefings have been held throughout Rounds 1, 2, and 3 with U.S. Senators and Representatives, as well as State Senators and Representatives to ensure they play an active role in the Program and stay up to date on Program activities, decisions, and key milestones.

These briefings are expected to continue on a regular basis as the Program moves forward. The Program team coordinates with MassDOT's Legislative Affairs Office to schedule meetings, identify invitees, and send invites. The Program team also prepares all necessary materials for each briefing, provides technical or in-person meeting support, and takes notes.

## 3. Targeted Stakeholder Meetings

Targeted stakeholder meetings have and will continue to occur during each phase of the Program. Stakeholders were identified based upon their mission, regional roles, membership (if applicable), and involvement in past Cape Cod Canal area transportation planning efforts including [MassDOT's Cape Cod Canal Transportation Study](#) and the [U.S. Army Corps of Engineers' Major Rehabilitation Evaluation Report \(MRER\)](#). The purpose of meeting with these stakeholders is to help best anticipate the needs and concerns of the broader public, remain responsive to stakeholder needs and concerns, and support a collaborative Program development process between stakeholders and MassDOT. A robust and inclusive stakeholder engagement process is key to achieving design consensus and successful program delivery. Benefits of this approach include the following:

- Allows for more meaningful engagement as meetings will be discussion-based and focus on specific stakeholder interests and answering their questions and concerns
- Creates a greater opportunity for stakeholders to engage the Program team and participate in conversations
- Allows more participants per organization due to the smaller, more individualized group meetings setting
- Supports the Program team's commitment to engage local and regional interests outside of public information meetings

The Program team organizes, prepares for, and facilitates each of the stakeholder meetings. Meeting materials have and will continue to include PowerPoint presentations, maps, and graphics. Meeting times are scheduled based on stakeholder availability and interest. Meetings

with specific groups may also be combined with others based on interests, information available, and existing community relationships.

During Phase 1 and 2, the Program team has met with the following groups:

1. Town of Bourne
2. Boston Region MPO
3. Cape Cod Canal Region Chamber of Commerce
4. Cape Cod Chamber of Commerce
5. Cape Cod Commission
6. Cape Cod Regional Transit Authority
7. Nantucket Planning and Economic Development Commission (NP&EDC)
8. Old Colony Planning Council
9. Sandwich Chamber of Commerce
10. Southeastern Regional Planning & Economic Development Commission (SRPEDD)
11. Southeastern Regional Transit Authority
12. The Woods Hole, Martha's Vineyard and Nantucket Steamship Authority
13. Joint Base Cape Cod

The Program team will continue to meet with these stakeholders moving forward, however, it is important to note that this list is subject to change as the team works to accommodate all reasonable community meeting requests and remain responsive to stakeholder communications and inquiries throughout the entirety of the Program. Briefings may also be grouped upon stakeholders, number of requests, and Program team availability.

For example, in future rounds of public engagement, the Program team may engage members of the new Canal Bridges Task Force that was formed by the Cape Cod Commission, the Cape Cod Chamber of Commerce, and the Association to Preserve Cape Cod in December 2022.

#### 4. Public Meetings

Three rounds of public meetings took place during Phase 1 of the Program, and the Program team will continue to regularly hold public meetings to provide updates and the latest available information, highlight key milestones, and allow the public to provide input and feedback on various aspects of the Program.

The purpose of the first round of public meetings was to introduce the proposed Program. These meetings were attended by 686 individuals. 565 individuals attended the second round of meetings, where the Program team presented on the Draft Purpose and Need, Draft Measures of Effectiveness Criteria, existing conditions, and next steps. The purpose of the third round of meetings was to update the public on the status, bridge types for consideration, and next steps, and these meetings were attended by 1,257 individuals.

A fourth round of public engagement took place in January 2023, in Phase 2 of the Program. This round of meetings allowed the Program team to present on the status of the Program, bridge types, proposed bridge lane configurations, potential bridge locations, and next steps. These meetings were attended by a total of 991 individuals.

These four rounds of meetings were therefore attended by a cumulative total of 3,499 individuals.

Each meeting has been and will continue to be open to anyone wishing to attend virtually and consists of a formal presentation by the Program team followed by an opportunity for public

questions and comments. Meeting invites and notification materials are posted and distributed at least two weeks prior to each meeting and have been translated into Spanish and Portuguese.

Interpreters have been made available at every public meeting. This has included:

- Spanish - 2 translators at each meeting
- Portuguese - 2 translators at each meeting
- American Sign Language (ASL) - 2 interpreters at each meeting
- Communication Access Realtime Translation - at least 1 CART provider at each meeting

Meeting notification materials have also included information on how the public can request additional language and translation services.

The Program team develops all meeting materials and schedules and distribute meeting invites and reminders. Meeting notes are taken and posted, in an accessible format, to the Program's website.

## 5. Pop-up Events

The Program team will attend community events to further engage and interact with the public. The purpose of attending these events is to meet the community at existing and convenient public gathering places to inform them of the Program and collect input. These meetings will be announced by the Program team in advance to ensure the community is aware and has an opportunity to engage with the Program team.

Events could include farmers markets, festivals, parades, art shows, and other community events that are anticipated to be well attended by members of the public. The Program team will coordinate attendance with the appropriate organizations and prepare Program information for distribution including handouts, maps, website and comment form links, and QR codes to online resources.

## 6. Open House

An open house will be held in the coming months to provide the public with an opportunity to meet with Program team in person, ask questions, and learn about Program updates in an informal setting. An agenda, materials, and expectations will be shared with stakeholders well in advance. An open house is beneficial as it affords the Program team more flexibility and creativity in providing meaningful experiences for stakeholder participation, and they provide an opportunity for stakeholders to interact with each other and the Program team in an organized and engaging setting. The open house will be held at an accessible location that is located in close proximity to the Program area. Future open houses may be held at various times throughout the project.

## 7. Environmental Justice Community Meetings

If throughout the course of the Program the Program team discovers an Environmental Justice population or localized group that requires increased coordination and attention, the team may host or attend community meetings with these populations. This could include hosting roundtable discussions, listening sessions, pop-up events, or attending prescheduled meetings or events to engage and solicit feedback from these groups.

## Program Website

A [Mass.gov Program website page](#) has been developed and published, and will continue to be available throughout the entirety of the Program. The purpose of the website page is to provide a centralized, easy navigable location for the public to access online resources and information on the Program. The Program team works closely with MassDOT's IT Office to ensure information published on the site remains up-to-date and complies with all applicable Title VI accessibility standards.

The website has been heavily utilized and has seen a high number of visitors. As of March 3, 2023, the website has been visited a total of 32,821 times by 22,107 different users.

In addition to the Program name and description, the website page has included and will continue to include the following:

1. Online Comment Tool

An [online comment tool](#), managed through the MassDOT Public Involvement Management Application (PIMA) is utilized to gather, evaluate, and respond to public inquiries on the Program. PIMA is a web-based application that incorporates elements of GIS to visualize feedback, measure public sentiment and program favorability, and track reach of engagement. A customized comment form is available on the Program website page and distributed to stakeholders throughout the duration of the Program.

Stakeholders are required to input specific information to register in the system and submit a comment, including name, zip code and email. Once registered, PIMA retains their information in the system for all future comments submitted. Stakeholders have the ability to sign up for project updates and request if and how they would like to receive responses to their comments (by mail, email, or phone call). In addition to the comment, stakeholder have the ability to select specific topic areas related to their comment, pin areas of concern on a map, and rate their favorability of the Program. Stakeholders receive a confirmation email every time they submit a comment and another notification email when a response has been entered by the Program team.

The Program team monitors PIMA regularly and remains responsive to all inquiries that are submitted. With each new comment submitted, an individual dialogue thread is created to promote continued and personalized communication. The Program team uses the information collected through the comment form including the comment, selected topics, pinned locations, and Program favorability to measure the effectiveness of outreach. This process is described in more detail in the "Measures of Effectiveness" section of this PIP. All data collected through PIMA is owned by MassDOT.

Depending on the nature and location of comments received, the Program team may adapt and adjust outreach strategies to reach new geographies and demographics. The comment form will be maintained as the centralized method for the public to communicate with the Program team.

2. Program Subscription Link

In addition to being able to subscribe to project updates through the comment form, there is also a [program subscription link](#) on the website page for the public to sign up for updates without having to submit a comment. The public is prompted to enter basic information, including name, zip code, and email address to be added to the list. This information, which is

owned by MassDOT, is stored in PIMA and used to disseminate Program correspondence such as public meeting invites and reminders, Program milestones, and construction updates. This link is being widely circulated at the onset of the Program through email blasts, social media posts, and Program materials to encourage the public to sign up to receive updates.

In addition to the comment form and subscription link hosted by PIMA, a phone number is also available on the Program website page. This phone number and voicemail is hosted through Google Voice and monitored on a regular basis by the Program team. Follow-up phone calls are being made by identified Program team members in a timely manner.

### 3. Public Meeting Recordings and Information

As detailed above, four rounds of public engagement have taken place as of March 3, 2023, with two public meetings taking place during each round. At each of these meetings, the Program team provided updates and an opportunity for public comment.

Recordings of these public meetings, as well as associated outreach materials are now contained on the Program website page. This allows the public and stakeholders to rewatch the meetings and have easy access to details regarding the Program.

Additionally, information about registering for future meetings is regularly posted on the Program website along with an overview of what each meeting entails.

### 4. Project Materials

The Program team is responsible for the creation of Program materials for outreach purposes. These materials include flyers, maps, pictures and graphics, and presentations. These materials are updated on a regular basis and available on the Program website. All materials meet MassDOT's accessibility requirements in order to accommodate all users.

### 5. Survey

Online surveys have been and will continue to be used to solicit feedback from the public throughout the Program. The Program team shared an online survey during the Round 3 meetings on November 15 and 17 in order to assess the public's preferences for the proposed bridge types. The survey closed on December 16<sup>th</sup>, 2022, and a total of 2,206 submissions were recorded.

## Program Communications

Consistent and clear communication is essential to effective public outreach. The Program team works closely to develop concise and informative communications content that engages the public and stakeholders and ensure they are aware of key details. All outgoing Program messaging is reviewed and approved by the Program team prior to distribution.

Communications methods that have been used and will continue to be used are as follows:

- Emails: Sent to stakeholders and interested parties to provide program updates, public meeting notifications and reminders, meeting invites and coordination, and details on upcoming outreach activities
- Letters: Notifying individuals of field work and providing formal response to stakeholder comments or inquiries
- Phone calls: Responding to stakeholder phone call inquiries and coordinating stakeholder meetings



- Press releases: Notifying statewide media outlets of important Program milestones, developments, and public meetings
- Newspaper advertisements: Included in print and digital publications in English and non-English languages to advertise public meetings. Publications used for round 3 of public meetings have a circulation of nearly 220,000 readers

## Branding

### 1. Messaging

A Program brand will be developed for uniformity and identity purposes. This brand will include a logo, color scheme, and specific language in compliance with MassDOT Highway Division policies. This brand will be used across all outreach materials to help support consistent and clear messaging to the public. The logo and brand will be reviewed and approved by MassDOT's Secretary and Highway Administrator.

Messaging may evolve and change throughout each Phase of the Program to accommodate schedule changes and community outreach needs. All changes and updates to messaging will be evaluated and reviewed thoroughly by the Program team on a regular basis.

### 2. Social Media

MassDOT's social media accounts are being utilized to disseminate messaging relating to Program milestones, public involvement opportunities, upcoming public meetings, and schedule updates. As of March 3, 2023, MassDOT has posted on social media platforms including Facebook, Twitter, and Instagram at least 40 separate times regarding the CCBP. These social media posts have been interacted with a total of 621 times and reshared a total of 58 times, helping to further amplify MassDOT's message and spread awareness of the Program.

As the Program continues to move forward, the team will continue to work to develop social media posts and plan campaigns in order to provide information and engage members of the public.

## Environmental Justice (EJ), Title VI, and Other Demographics

The Massachusetts Executive Office of Energy and Environmental Affairs (EEA) established an Environmental Justice Policy in 2002 to address the disproportionate share of environmental burdens experienced by low-income persons, minority communities, and non-native English speakers. In addition to ensuring protection against environmental pollution, this policy is designed to promote community engagement in environmental decision-making processes. The policy was most recently updated in June of 2021. Massachusetts defines Environmental Justice populations as neighborhoods that meet one or more of the following criteria<sup>2</sup>:

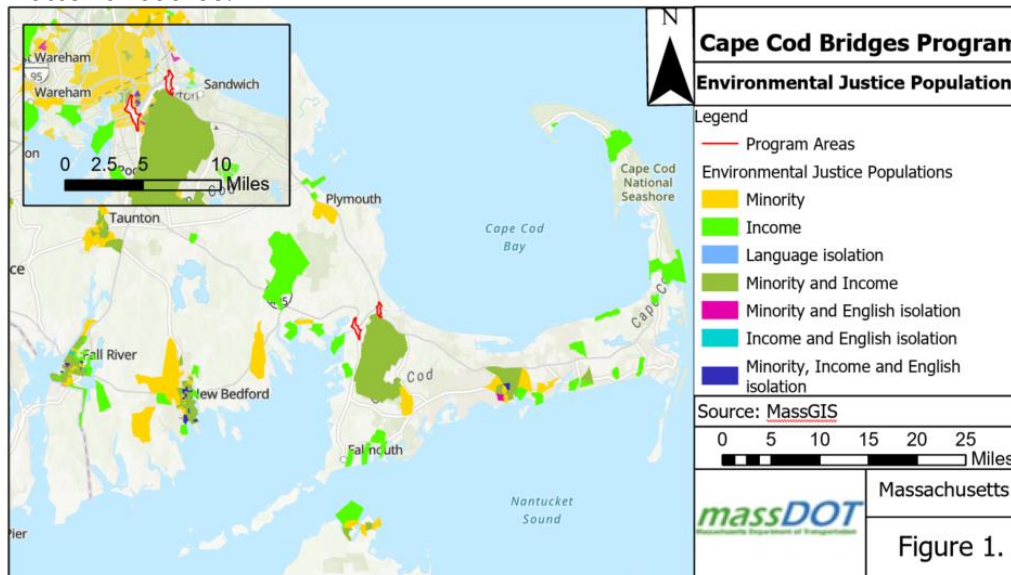
- The annual median household income is not more than 65 per cent of the statewide annual median household income
- Minorities comprise 40 per cent or more of the population
- 25 per cent or more of households lack English language proficiency
- Minorities comprise 25 per cent or more of the population and the annual median household income of the municipality in which the neighborhood is located does not exceed 150 per cent of the statewide annual median household income

---

<sup>2</sup> [https://www.mass.gov/files/documents/2017/11/29/2017-environmental-justice-policy\\_0.pdf](https://www.mass.gov/files/documents/2017/11/29/2017-environmental-justice-policy_0.pdf)

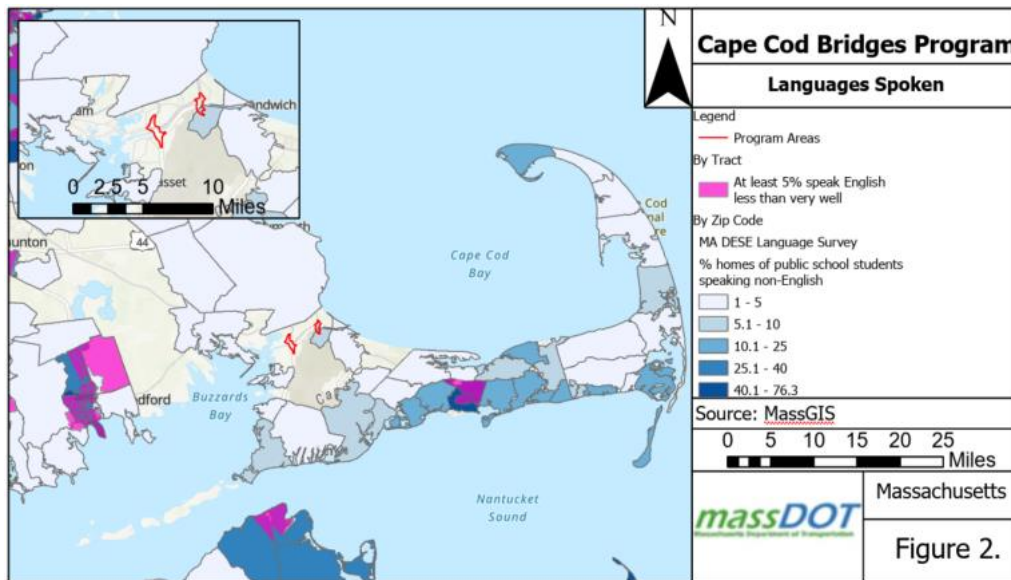
Cape Cod and the surrounding region is made up of diverse communities of people. *Figure 1* demonstrates the location of block groups meeting one or more EJ threshold in the regions surrounding the Program area. An EJ block group located to the southwest of the Mid-Cape Connector within the Joint Base Cape Cod abuts the Sagamore Program area. There are groupings of other EJ populations close to the Program area in Wareham, Falmouth, Barnstable, and New Bedford. Due to the diversity and unique character of the overall region and state, all public outreach is being done in a thoughtful, inclusive, and consistent manner so that all stakeholders, regardless of demographic or geography, have equal access to outreach opportunities. MassDOT will continue to work closely with community and advocacy organizations to leverage existing communications channels to engage with EJ populations throughout Program development.

According to MassDOT's Engage Tool<sup>3</sup>, the non-English languages spoken in census tracts directly abutting the project area are Spanish, Greek, and Chinese. However, as *Figure 2* conveys, the percentages of the census tract populations that only speak non-English languages are relatively low. Due to the regional nature of this project, it is important to consider the larger regional area of impact to assess potential translation service needs as a matter of course.



*Figure 2* demonstrates languages spoken in the regions surrounding the Program area to guide the translation of written materials for LEP populations. There are no Census Tracts meeting the "safe harbor" threshold, where at least 5% of the population has speakers who report they do not speak English "very well" or 1,000 persons of the total population qualified to be served. However, due to the language information provided by MassDOT's Engage Tool, and the regional significance of this Program, Spanish and Portuguese translations of specific Program materials have been and will be made available throughout the duration of the Program. These are the top two languages spoken in the state of Massachusetts. These materials include the Program's comment form, virtual meeting, flyers, public notices, and newspaper advertisements. All material translations are reviewed thoroughly by appropriate parties to ensure accuracy in information.

<sup>3</sup> <https://gis.massdot.state.ma.us/engage/>



Translation services and translations of specific Program materials in other languages beyond Spanish and Portuguese are also made available upon request. All Program messaging, including public meeting notification materials, include language on how members of the public can request additional accessibility and accommodation services are available in English, Spanish, and Portuguese. All meeting notification materials are distributed at least two weeks prior to each meeting to provide the public adequate time to plan to attend and make any requests for translation and accommodations services. The Program team is required to fulfill all reasonable translation and accessibility requests made by the public.

In addition to regional EJ and language considerations, this public involvement effort recognizes the diversity in age demographics on Cape Cod. According to the most recent census data from Barnstable County on age demographics (2022), 31.4% of the population is 65 years and over.<sup>4</sup> This is nearly double the state percentage of persons 65 years and over.<sup>5</sup> The table below outlines the differences in populations demographics in Barnstable County compared to statewide demographic data. Due to the significance in older populations, all engagement materials are prepared well in advance to accommodate different mobility and technology needs. The Program team provides call-in options for all virtual meetings and as previously detailed, will conduct in-person outreach to accommodate populations with limited internet and technology access.

	Persons under 5 years (%)	Persons under 18 years (%)	Persons 65 years and over, (%)
Barnstable County	3.5%	14.4 %	31.8 %
Massachusetts	5.0%	19.5%	17.4%

Source: US Census Bureau

The Program team verifies that all materials posted on the project website including presentations, graphics, handouts, and maps are made accessible in compliance with Section

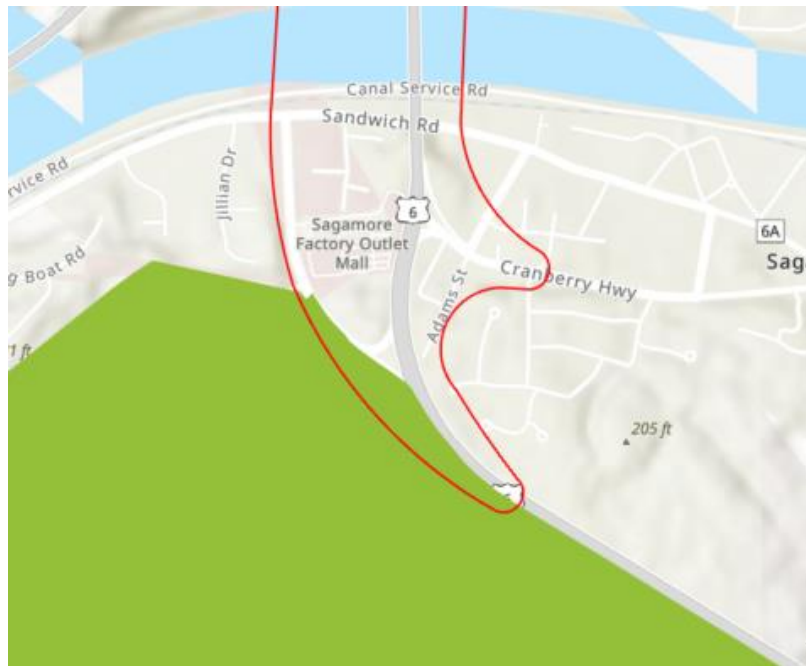
<sup>4</sup> <https://www.census.gov/quickfacts/fact/table/barnstablecountymassachusetts/PST045219#>

<sup>5</sup> <https://www.census.gov/quickfacts/MA>

508 of the Rehabilitation Act.<sup>6</sup> This Act applies to government agencies and requires that all electronic and information technology is accessible to employees and members of the public with disabilities. The Program team has worked closely with the MassDOT IT Office to develop and deploy PIMA in an accessible format. PIMA has passed multiple MassDOT accessibility audits. Therefore, all PIMA materials on the Program website page including the comment form, Program subscription link, and virtual meeting are being maintained in accordance with all applicable accessibility guidelines.

## EJ Update

This PIP utilizes the latest Executive Office of Energy and Environmental Affairs (EEA) Environmental Justice Populations in Massachusetts data to ensure the PI team is sufficiently reaching all EJ communities in Cape Cod and the surrounding region. The U.S. Census Bureau has recently updated this data, including its information on EJ populations. This latest update shows there is only one area designated as EJ for Minority and Income within the southwestern portion of Sagamore Program area that is part of the Joint Base Cape Cod and comprised of undeveloped, forested land. This location is shown below in *Figure 3*.



To verify this updated data, the Program team may conduct the following activities in future rounds of outreach:

- **Coordinate with churches and faith-based organizations:**
  - The Program team will identify churches and faith-based organizations in the Project area
  - Program information will be shared with leaders and their membership, and they will be provided with opportunities to connect directly with the Program team
- **Host pop-up events:**

<sup>6</sup> <https://www.access-board.gov/the-board/laws/rehabilitation-act-of-1973#508>

- The Program team may attend community pop-up events to meet members of the community during public gatherings and inform them of the Program and solicit feedback
  - Events include those previously detailed as well as additional concerts, farmers markets, art festivals, and other community events
  - These events will be specifically targeted towards EJ communities, and the Program team may partner and work with organizations that serve those constituencies.
  - At these events, the Program team will specifically seek feedback on EJ communities with the local area.
- **Launch new surveys and polls at public meetings:**
  - A survey that includes demographic data will be developed and distributed in person or online. This optional survey seeks to solicit data that will enable the Program team to better understand the individuals they engage.
  - A survey or poll has been and will continue to be used at public meetings in English, Spanish, and Portuguese prompting the public to provide additional feedback on the translation services provided during the public meetings. This will allow the team to collect data on the utilization of these services.
  - For example, the result of the surveys used at the Round 4 public meetings indicated that at the meeting on January 24, 2023, one individual utilized ASL services, and one individual utilized Spanish translation services. At the January 26, 2023, public meeting, one individual utilized ASL services, and another individual utilized Portuguese translation services.
- **Increased coordination with EJ focused groups:**
  - In Phase 1 of the Program, the Program team provided information and translated materials to groups which address and assist Environmental Justice communities, including, but not limited to those with low income and limited English proficiency.
  - This helped to help spread awareness of public meetings and milestones
  - By increasing coordination with EJ focused groups, and offering additional outreach such as personalized briefings, the Program team will be able to concentrate their efforts on fostering relationships with community members who may otherwise be excluded in the public process.
  - This will also help the Program team ascertain the reach and membership of these organizations.

## Public Involvement Tasks

The table below outlines public involvement strategies as well as the tasks and deliverables associated with each strategy. It is important to note that many of these items are ongoing or concurrent with other items.

The purpose of this table is to provide a general guide of outreach activities that may take place as the Program moves forward. Additionally, this table will be adjusted as the Program progresses to reflect updates to schedule, approach, and stakeholder engagement strategies.

Strategies	Tasks
Public Involvement Plan	<ul style="list-style-type: none"> <li>● Continue to update PIP               <ul style="list-style-type: none"> <li>○ Evaluate effectiveness and make continuous updates as needed</li> </ul> </li> </ul>

Outreach Schedule	<ul style="list-style-type: none"> <li>• Implement current outreach schedule <ul style="list-style-type: none"> <li>○ Carry out identified meetings</li> </ul> </li> <li>• Further develop schedule of outreach activities as the Program moves forward</li> </ul>
Branding	<ul style="list-style-type: none"> <li>• Develop logo</li> <li>• Draft, review, and finalize messaging</li> <li>• Create project video in alignment with approved messaging</li> <li>• Coordinate with Program team to create social media campaign <ul style="list-style-type: none"> <li>○ Develop content and messaging</li> <li>○ Draft posting schedule</li> </ul> </li> </ul>
Website	<ul style="list-style-type: none"> <li>• Continue to update and refine website based on Program developments and public feedback</li> <li>• Add information on Program milestones to the website as it becomes available</li> <li>• Ensure public meeting recordings and materials are available on the website</li> </ul>
Advisory Group Meetings	<ul style="list-style-type: none"> <li>• Support the establishment of a Advisory Group</li> <li>• Assist with planning and hosting Advisory Group meetings and allowing members to provide input and feedback for the Program</li> </ul>
Legislative Briefings	<ul style="list-style-type: none"> <li>• Continue to host regular elected official briefings throughout the duration of the Program</li> </ul>
Stakeholder Meetings	<ul style="list-style-type: none"> <li>• Schedule and conduct stakeholder meetings with specific individuals, groups, and organizations</li> <li>• Targeted meetings are being hosted in coordination with public meetings.</li> </ul>
Public Meetings	<ul style="list-style-type: none"> <li>• Host meetings will be held throughout Spring and Summer 2023 and in subsequent phases of the Program</li> <li>• These meetings will provide updates on the Program and opportunities for the public to engage and provide feedback</li> </ul>
Open House	<ul style="list-style-type: none"> <li>• Identify open house opportunity throughout the Spring and Summer</li> <li>• Host open house as an additional method to interact and engage with stakeholder groups and gather feedback</li> </ul>
Community Pop-Up Events	<ul style="list-style-type: none"> <li>• Continue identifying potential local community events</li> <li>• Attend community events in order to better engage with local members of the community, EJ populations, and stakeholders</li> </ul>
Churches	<ul style="list-style-type: none"> <li>• Identify churches and local religious organizations in the Program area</li> <li>• Conduct outreach to these entities to better share information with their leadership and members</li> </ul>
EJ-Focused Groups Coordination	<ul style="list-style-type: none"> <li>• Continue identifying groups and organization focused on supporting EJ populations</li> </ul>

	<ul style="list-style-type: none"> <li>• Increase coordination and outreach to these groups</li> </ul>
Manage Messaging and respond to stakeholder Inquiries	<ul style="list-style-type: none"> <li>• Track, record, and respond to comments in PIMA on a regular basis</li> <li>• Develop PIMA comment summaries on a weekly basis to be reviewed and approved by the Program Team</li> </ul>

## Measures of Effectiveness:

Throughout Phase 1 of the Program and into Phase 2, there has been a high level of public engagement and interest. For example, as detailed above, the four rounds of public meetings were attended by a cumulative total of 3,499 individuals. Additionally, as of March 3, 2023, the Program team has received over 1,600 comments and questions from the online comment form, emails, phone calls and public meetings. This has included feedback on a wide variety of topics including construction, cost, traffic impacts, bridge design, right of way, and numerous others.

The steps described below will continue to be taken by the Program team to measure the effectiveness of outreach. Measures of effectiveness for public involvement are important in evaluating the efficacy of outreach efforts to verify the goals and objectives outlined in this plan are being adequately met. Strategies may be adjusted and adapted to better fit the needs of community feedback.

### Step 1: Continue conducting outreach

- Manage and update the stakeholder database for Program communication
- Distribute communications to stakeholders and the public
- Respond to all stakeholder comments, inquiries, and requests in a timely manner
- Regularly post on MassDOT's social media accounts
- Host public and stakeholder meetings with adequate notification materials and timeline

### Step 2: Regularly evaluate public response and perception

- Monitor the public's level of engagement with the Program
  - Number of inquiries received through PIMA, email, letter and phone call
  - Number of public meeting attendees
- Determine level of support for Program
  - Nature of comments, inquiries, and requests
- Assess the geographies and demographics of collected comments and inquiries, and meeting attendees
  - Utilize PIMA's mapping and analytics tools to evaluate stakeholder and comment information

### Step 3: Reflect on the Program team's outreach efforts

- Are elected officials being properly notified of the Program?
- Are EJ populations being effectively engaged?
- Are all translation and accessibility requirements and requests being met?
- Are regional stakeholders being engaged?
- Are comments, inquiries, and requests being responded to in a timely manner?

- Are diverse and widespread stakeholder individuals, groups and organizations being engaged?
- Are abutters and local property owners aware of Program outreach and communication opportunities?
- Is the Program in compliance with state and federal regulations regarding property acquisitions?
- Is the public being adequately notified of all public meetings and outreach activities to give them ample opportunity to participate?

**Step 4:** Alter or adapt outreach strategies during subsequent Program phases (if necessary)

- Target specific stakeholder groups or geographic areas where engagement may be lacking
- Offer individual briefings with specific individuals, groups, or organizations to disseminate information and collect feedback
- Update messaging to address inquiries, concerns and keep information relevant to stakeholders
- Create supplemental information and materials to assist outreach purposes and goals

As noted previously, this PIP will remain flexible throughout the Program and strategies will continually be evaluated and updated to best fit the needs of the Program, communities, and public participation levels. Measuring the effectiveness of outreach will aid the Program team in facilitating a robust public process where everyone is given ample and equal opportunity to participate and provide feedback on Program development.

## Challenges and Solutions

Throughout the first phase of the Program, several current and future challenges to the public involvement and outreach process have been identified. While these issues are not necessarily critical in nature, it is nonetheless important for the Program team to enact mitigation measures and solutions in order to ensure effective outreach. These challenges and the solutions are described below.

Challenge	Mitigation Measures/Solutions
Desire for increased engagement and input from local community stakeholders	<ul style="list-style-type: none"> <li>• Establishing Program Advisory Group to allow local stakeholders to directly provide input and feedback in a close setting</li> <li>• Continuously updating Program website and ensuring the availability of Program documents and resources</li> <li>• Regular briefings and engagement with local organizations, officials, and stakeholders</li> </ul>
Evaluating effectiveness of engagement strategies and accessibility measures	<ul style="list-style-type: none"> <li>• Utilizing surveys to better understand usage of translation services</li> <li>• Increasing coordination with local community groups and organizations</li> <li>• Conducting in-person outreach to allow for more conversations and engagement with the public</li> </ul>
Frequent public meetings	<ul style="list-style-type: none"> <li>• Ensuring timely distribution of meeting notification materials to the public</li> </ul>



Challenge	Mitigation Measures/Solutions
	<ul style="list-style-type: none"> <li>Increased coordination among the Program team to ensure the appropriate development of meeting and notification materials</li> </ul>
Demonstrating coordination with elected officials	<ul style="list-style-type: none"> <li>Refining messaging to underscore collaboration and coordination with elected officials</li> <li>Highlighting elected officials briefing and outreach to clarify that these officials are aware of an in support of the Program</li> </ul>
Responding to high levels of comments and questions in public meetings	<ul style="list-style-type: none"> <li>Adding additional time to public meetings to accommodate high levels of comments and questions</li> <li>Providing answers via email to all questions not answered or addressed within public meetings</li> </ul>
Accommodating requests for additional information	<ul style="list-style-type: none"> <li>Developing FAQ which will be posted on the Program website</li> <li>Providing timely responses to all incoming questions and comments over email, PIMA, and through phone calls</li> </ul>
Large amount of information being conveyed to the public	<ul style="list-style-type: none"> <li>Revamping website to include more comprehensive information regarding the Program</li> <li>Adding a "Latest Updates" section to the Program website where the public can easily see the most recent updates and information</li> </ul>

## National Environmental Policy Act (NEPA) Process

A comprehensive public involvement campaign is essential to the NEPA processes. Successful public involvement helps mitigate Program risk by involving the public and stakeholders in the project development process early and often. The outreach strategies discussed in this PIP provide the public with the opportunity to communicate support or objection to the proposed Program scope. The input collected will determine what level of controversy exists, and therefore be considered in the final NEPA decision.

FHWA will identify the probable class of action (COA) for the Cape Cod Bridges Program under NEPA as soon as sufficient information is available to identify potential impacts of the action. MassDOT, in consultation with FHWA will, at the earliest appropriate time during the environmental review process, provide opportunities for participating agencies to advise them regarding the Cape Cod Bridges Program and to achieve the following objectives:

- Determine the range of alternatives to be considered for the Cape Cod Bridges Program to build upon the conclusion of the USACE's MRER
- Determine which aspects of the Cape Cod Bridges Program have potential for social, economic, or environmental impact,
- Identify alternatives and measures that might mitigate adverse environmental impacts, and
- Identify other environmental review and consultation requirements that should be performed concurrently with the NEPA document.

MassDOT will accomplish these objectives through early coordination activities. The public involvement process will be summarized, and the results of agency coordination will be

included in the NEPA document. FHWA is required to approve the NEPA document before it is made available to the public as an FHWA document.

The NEPA document will be made available for public review at MassDOT and at the FHWA Massachusetts Division Office for 30 days. MassDOT will send the notice of availability of the NEPA document, briefly describing the action and its impacts, to the affected units of Federal, Tribal, State, and Local government. MassDOT will also leverage the use of Cape Cod Bridges Program website to make environmental documents, environmental studies (e.g., technical reports), relevant notices, and other relevant information available to other agencies and interested public parties.

In accordance with 23 CFR 771.111(h)(2)(iii), one or more public hearings are to be held by the State highway agency at a convenient time and place for any Federal-aid project that requires significant amounts of right-of-way, substantially changes the layout or functions of connecting roadways or of the facility being improved, has a substantial adverse impact on abutting property, otherwise has a significant social, economic, environmental or other effect, or for which the FHWA determines that a public hearing is in the public interest.

MassDOT will provide the public with reasonable notice of a public hearing or the opportunity for a public hearing in accordance with 23 CFR 771.111(h)(2)(iv). Notification will occur at least two weeks prior to the date of the public hearing. Such notice will also provide information required to comply with public involvement requirements of other laws, executive orders, and regulations. Per 23 CFR 771.111(h)(2)(v), MassDOT will provide explanation at the public hearing of the following information, as appropriate:

- The purpose and need for the Cape Cod Bridges Program, and its consistency with the goals and objectives of any local or regional planning documents,
- Cape Cod Bridges Program alternatives and major design features,
- The social, economic, environmental, and other impacts of the Cape Cod Bridges Program,
- The relocation assistance program and the right-of-way acquisition process, and
- The procedures for receiving both oral and written statements from the public.

MassDOT will submit to FHWA a copy of the transcript of each public hearing and certification that a required hearing or hearing opportunity was offered. The transcript will be accompanied by copies of all written statements from the public, both submitted at the public hearing or during an announced period after the public hearing.

When a public hearing is held as part of the environmental review process for the Cape Cod Bridges Program, the NEPA document will be made available at the public hearing and for a minimum of 15 days in advance of the public hearing. MassDOT will publish a notice of the public hearing in the official local newspaper(s) that announces the availability of the NEPA document and where it may be obtained or reviewed. Additionally, MassDOT will post the NEPA document on its website for public review and comment. Comments will be submitted in writing to MassDOT or FHWA within the 30-day availability period of the NEPA document unless FHWA determines, for good cause, that a different period is warranted.

It is critical that feedback received throughout the entirety of this Program be carefully tracked and readily available for inclusion in any required environmental documentation. Therefore, PIMA is being utilized as a centralized management system to track and record comments, responses, favorability, stakeholder demographics and other engagement analytics. PIMA is used to evaluate public sentiment and the level of support that may exist among stakeholders and the surrounding communities. Data is being stored to provide a complete catalogue of comments and quantitatively demonstrate changes in public sentiment throughout project development. All information collected in the system can be easily exported to an accessible format that can be incorporated into subsequent environmental documentation.

## Section 106 of the National Historic Preservation Act

Section 106 of the National Historic Preservation Act (NHPA) and its implementing regulations (36 CFR part 800) require Federal agencies to consider the effects of their undertakings on historic properties, and when applicable, provide other consulting parties and the public an opportunity to comment on such undertakings prior to the expenditure of any Federal funds or prior to the issuance of any Federal permit, license, or approval. MassDOT, as FHWA's delegate under Section 106, is responsible for ensuring that public involvement efforts under Section 106 are consistent with FHWA requirements.

MassDOT's Cultural Resources Unit (CRU) initiates the Section 106 process by establishing that a proposed Federal action is an undertaking as defined in 36 CFR 800.16 and providing early notification of the undertaking to the Massachusetts State Historic Preservation Officer (MA SHPO), local historical commissions, Tribal Historic Preservation Officers (THPOs), Federal and State Agencies, and any other interested parties about impacts on historic properties, as applicable.

MassDOT implements requirements for submitting early project notification letters to the MA SHPO, local historical commissions, THPOs, government entities and other interested parties in the Section 106 process through the procedures outlined in an Engineering Directive titled *Early Environmental Coordination for Design Projects* and through its existing public participation program.

As part of the Section 106 process, MassDOT will engage MA SHPO, THPOs and other individuals, agencies, and organizations likely to have knowledge of, or concerns with, historic properties in the direct and indirect Area of Potential Effect (APE) established for the Cape Cod Bridges Program and identify issues relating to the undertaking's potential effects on any identified historic properties.

If MassDOT CRU's review suggests that the Cape Cod Bridges Program may affect historic properties within the APE, MassDOT CRU will apply the criteria of adverse effect in 36 CFR 800.5(a) to determine if the effect will be adverse. MassDOT CRU also considers any views concerning such effects, provided by any consulting parties and the public.

In event the Cape Cod Bridges Program is found to have an adverse effect on any historic property, FHWA will notify the Advisory Council on Historic Preservation (ACHP) of the adverse effect and continue consultation with the SHPO and other consulting parties, as appropriate. The views of the public will also be considered at this stage in the process. The goal of the ongoing consultation and public involvement is to develop and evaluate

alternatives or modifications to the undertaking that could avoid, minimize, or mitigate adverse effects on historic properties.

If the adverse effect cannot be avoided, FHWA and MassDOT will enter a Memorandum of Agreement (MOA) with the SHPO, ACHP and other consulting parties, as warranted. The MOA will be a legally binding document that records the terms and conditions agreed upon to minimize or mitigate the adverse effects of the Cape Cod Bridges Program upon historic properties. Once an MOA is executed among all consulting parties, the Section 106 process is complete.

## Section 4(f) of the Department of Transportation Act

Section 4(f) refers to the original section within the U.S. Department of Transportation Act (US DOT) of 1966, which established the requirement for consideration of park and recreational lands, wildlife and waterfowl refuges, and historic sites during the transportation project development process. The law, now codified in 49 U.S.C. §303 and 23 U.S.C. §138, is implemented by FHWA through regulation [23 CFR Part 774](#). Section 4(f) applies to all transportation projects that require funding or other approvals from an agency of the USDOT.

MassDOT, in consultation with FHWA, will provide for public notice and an opportunity for public review and comment on any transportation use of a Section 4(f) park, recreation area, wildlife or waterfowl refuge, or historic site processed through the following approvals:

- de minimis impact determination<sup>7</sup>,
- Nationwide Programmatic Section 4(f) Evaluation and Approval for Transportation Projects That Have a Net Benefit to a Section 4(f) Property, and/or
- Individual Section 4(f) evaluation

## Conclusion

A comprehensive and thoughtful public involvement process is essential to the success of this Program and building community consensus. The strategies outlined in this PIP are assisting MassDOT in providing a transparent and inclusive public process for all stakeholders, regardless of demographic or geography. While this PIP discusses the public involvement strategies specific to the next several months, many of these strategies will be utilized throughout subsequent phases of the Program to promote continuity in messaging and approach. This PIP will be evaluated regularly and will be updated to reflect changes in Program delivery and schedule, and outreach strategies.

---

<sup>7</sup> Compliance with 36 CFR Part 800 will satisfy the public involvement requirement for de minimis impact findings for historic sites.

## 9.3 Cape Cod Bridges Program FAQs

# The Cape Cod Bridges Program



## Frequently Asked Questions

### Background

What is the scope and schedule of this Program?

This Program is a continuation of Massachusetts Department of Transportation's (MassDOT's) Cape Cod Canal Study and the U.S. Army Corps of Engineers' (USACE) Major Rehabilitation Evaluation Report (MRER). The Program will include the eventual replacement of the Bourne and Sagamore Bridges as well as multimodal improvements to the approach roadway networks. Design alternatives for the bridges and roadways are being developed in conjunction with a robust public engagement process.

Construction is anticipated to commence after MassDOT completes preliminary design and environmental permitting. There are many factors that will influence schedule, including but not limited to: identification of construction funding, determination of the National Environmental Policy Act (NEPA) Class of Action, public feedback, packaging of construction contracts and construction procurement methodology, and more. This information will develop as the program progresses and will be communicated in future rounds of public engagement.

Estimated Program milestones that are subject to change include:

- Phase 1: Beginning in June of 2021, efforts have involved public outreach and involvement and data collection to include environmental conditions and traffic patterns.
- Phase 2: Based on public input, MassDOT develops and refines bridge and roadway options.
- Phase 3: MassDOT identifies preferred options. Environmental documentation process begins. Design development.
- Phase 4: MassDOT completes preliminary design and environmental permitting.
- Phase 5: Construction underway.
- Delivery: The Cape Cod Bridges Program is completed.

Is this a MassDOT or USACE Program?

MassDOT and the USACE signed a Memorandum of Understanding (MOU) in July 2020. Per the MOU, MassDOT will lead the design and assume ownership of the new bridges. USACE will continue to own, operate, and maintain the existing Bourne and Sagamore Bridges. If you have questions or comments regarding ongoing or planned maintenance activities associated with the existing canal bridges, please reach out to [CapeCodCanal@usace.army.mil](mailto:CapeCodCanal@usace.army.mil) or (508) 759-4431.

### What is the Purpose and Need?

The Program is in the process of developing the Purpose and Need as a requirement under the National Environmental Policy Act. The Program Purpose and Need defines the range of reasonable alternatives and assists in the identification of a preferred alternative. The development process involves incorporating comments received through public outreach in coordination with federal partners for approval by USACE and FHWA. The Draft Program Purpose and Need is as follows:

“The Purpose of the Cape Cod Bridges Program is to improve cross-canal mobility and accessibility between Cape Cod and mainland Massachusetts for all road users and to address the increasing maintenance needs and functional obsolescence of the aging Cape Cod Canal highway bridges. The Program will improve traffic operations and multimodal accommodations to facilitate the dependable and efficient movement of people, goods, and services across the Cape Cod Canal.”

### Why will the bridges take so much longer to build than the original bridges?

When the existing Bourne and Sagamore bridges were constructed, the canal had not yet been constructed to its current width, and the existing roadways and shorter bridge crossings were not in the same footprint as the bridges being built. The construction staging required to replace the bridges while maintaining safe navigational and roadway traffic makes the current project take longer to construct.

### What is the funding source and cost share for the Program?

At this time, the cost share has not been determined. USACE and MassDOT have and will continue to apply for federal funding presented by the Infrastructure Investment and Jobs Act (IIJA). The Program was not awarded funds under the 2022 Nationally Significant Multimodal Freight & Highway Projects or the Bridge Investment Program pursuits and is awaiting the results of its 2022 National Infrastructure Project Assistance program pursuit.

## Community Engagement

### How will the community be involved in Program development?

A robust public engagement process has been initiated and will continue throughout the duration of the Program. Public meetings have and will continue to be accessible to all members of the public and will include formal presentations by the Program team as well as opportunities for feedback and questions. Online resources, including a comment form, are available on the Program’s website page (<https://www.mass.gov/cape-bridges>) throughout design and construction.

### When will public meetings take place?

Regular public meetings have and will continue to occur at key Program milestones. All public meetings are announced on the Program website well in advance of each meeting. Public meetings are also announced through email notifications, newspaper advertisements, flyers, MassDOT’s social media accounts, and press releases to regional media outlets. Presentations from previous meetings are available on the Program’s website page (<https://www.mass.gov/cape-bridges>) through the duration of the Program.

## Design considerations

Why do we need bridges anymore? Were other options other than replacing the bridges considered?

The alternative analysis was completed as a follow-up to the Major Rehabilitation Evaluation Report (MRER) and the Environmental Assessment (EA), which considered multiple options to addressing the aging infrastructure. For instance, tunnels were eliminated from detailed analysis based on high costs and extensive impacts on the environment and land uses. Double decked bridges would require additional height that would lead to a much longer approach bridge structure to get the top roadway down to grade at either side of the canal, which would have larger impacts to the existing roadway networks and neighborhoods. The MRER/EA concluded the preferred alternative was replacing the bridges at or near the existing sites. MassDOT is continuing the evaluation of the Cape Cod Bridges Program based on these findings.

What are the bridge design considerations?

The Program to be constructed would maintain the existing federal navigation channel and provide 135-feet of vertical navigational clearance. The Program proposes twin bridges at each location as this design expedites traffic off the bridges, best maintains traffic flow during construction, is more efficient structurally, and is more easily constructed. MassDOT is considering both a pier span length in the riprap portion of the Canal and a pier span located on land outside of the Canal. MassDOT understands the bridges are iconic as the gateways to the Cape and is taking aesthetic appeal, appearance, and visibility into consideration during the Program development process. MassDOT is prioritizing safety of all users access the structures to include lighting, separation of vehicles and pedestrians, and barriers along the sides of the bridges.

Why will there be two bridges at each crossing instead of one?

There will be two bridges at each crossing because they are more cost effective, structurally efficient structures and allow for staged construction while keeping two lanes of traffic operational in both directions and allowing all existing roadway connections to be maintained. The new crossings will be wider to meet current highway standards, and a single wider structure at each crossing would be difficult to construct and be more costly overall.

Are the bridges being built higher to account for future sea level rise?

Sea level rise is being considered to ensure the minimum vertical clearance can be maintained over the lifespan of the bridges.

## Program Impacts

Will my property be impacted?

MassDOT is beginning to develop bridge alignment alternatives and will be determining Right of Way impacts in the coming months. Ample opportunity to comment on the potential alternatives will be provided as part of the preferred alternative selection process.

Will the approach roadways be redesigned?

The Program seeks to improve traffic operations and multimodal accommodations to facilitate the dependable and efficient movement of people, goods, and services across the Cape Cod Canal. Roadway



realignments, lane configurations, and traffic will be upcoming discussion topics in future public meetings in early 2023.

Will there be roadway or canal impacts during construction?

MassDOT is evaluating program alternatives that will maximize constructability, including maintaining two traffic lanes in each direction at each crossing during construction, maintaining all connections to the local roadway network at locations like the existing condition during construction, and minimizing impacts to the traveling public. The goal of the Program is to keep at least a portion of the Cape Cod Canal open to vessel traffic during construction. Depending on the option chosen, there may be a brief full closure of the Canal while the center spans of the replacement bridges are lifted into place. Traffic impacts will be evaluated and communicated as part of a transparent alternative's analysis process. All public feedback will be taken into consideration when selecting a preferred alternative.

Will the bridges be tolled?

Tolls are not being considered at this time.

Are there any environmental or historical considerations?

The environmental and historic impacts will continue to be evaluated during the planning phase as identified in the Measures of Effectiveness and prioritized throughout the Program. As MassDOT dives deeper into those reviews, it will have a better understanding of the potential of the Program to result in any adverse impacts and will plan mitigation efforts to avoid or minimize them to the extent feasible. The Program team will need to obtain several permits prior to construction and implement various protection measures during construction. For instance, the Canal District and the bridges have been determined to be eligible for listing on the National Register of Historic Places and as such are afforded the same protections as those that are listed on the National Register. MassDOT has initiated coordination with the Massachusetts Historical Commission, and that coordination will continue throughout the process of this Program.

Pedestrians, bicycles, and other non-vehicular traffic

Is this Program addressing passenger rail service?

Rail is not being explored as grading constraints would require the approach roadway network to extend for miles. Could the existing bridge be used for bikes and pedestrians?

The existing bridge will be decommissioned after the completion of the project.

Will there be multimodal accommodations provided through this Program?

Multi-modal transportation access is an important key component of this Program. The Program is required to provide a sidewalk during construction and a Shared Use Path for pedestrians and cyclists in the final condition.

Will there be a Shared Use Path on both bridges?

The current plan is to have one path at the Bourne crossing and one at the Sagamore crossing. They will be wide enough to safely support bidirectional traffic of bicyclists and pedestrians. This topic will be discussed further at future public meetings as the preliminary design progresses.

Are the new bridges going to obstruct the views of the canal?

The new bridges will maintain or improve the views of the canal from the bridges.

Will there be seating along the sidewalk for people to sit and enjoy the view?

The Shared Use Path will have overlooks for sitting and viewing the canal. This topic will be discussed further at future public meetings as the preliminary design progresses.

## Bridge Type Questions

Why are aesthetics being taken into consideration at all?

Aesthetics are just one of many aspects being considered when choosing the bridge type.

Which bridge type has the Lowest Cost?

The Arch bridge type has the lowest preliminary cost estimate. The Cable Stayed bridge has a most expensive cost per square foot and therefore, would have a more expensive total cost. The Concrete Box would require longer spans to maintain shipping clearance over the canal and would have much larger foundations to support a heavier bridge, making the total cost higher.

Which bridge type is the most resistant to extreme wind events?

All three bridge types would be designed to withstand anticipated future storms.

Which bridge type has the longest lifespan with the lowest maintenance impacts and cost?

All three bridge types would be designed and constructed to achieve a 100-year lifespan. Maintenance on all three modern bridge types would have much lower costs and impact on traffic than maintenance on the existing truss bridges. Any of the three modern bridge types would be designed and constructed for ease of maintenance while minimizing impact to traffic.

Does one bridge type have more property impacts than the others?

The decision on bridge type will not affect the extent of property impacts. Right of Way impacts will be associated with bridge and roadway alignment. Alignment alternatives will be developed in the coming months with ample opportunity for public comment and input.

Which bridge type has the shortest construction duration?

The Arch bridge type is able to be built using the accelerated building technique of fabricating the arch span offsite and lifting it into place, which will allow for the shortest construction duration. The cable stayed bridge type and the concrete box would take longer to construct.

Will snow and ice buildup on the arch/cables?

Snow and ice buildup has not been a significant issue on the type of arch bridge being considered but could potentially be an issue on cable stayed bridges.

Could the bridge be replaced with a truss arch, like what is there now?

The truss bridge type was a technological achievement when it was built in the 1930's, but modern bridge designs have been developed which cost much less to construct and are better designs for the lifespan of the bridge. Trusses are not designed for ease of maintenance and require greater traffic impacts when repairs are necessary.

Are there maintenance considerations?

Each of the potential bridge types offers significantly simpler maintenance and operation in terms of time and cost in comparison to the current Bourne and Sagamore bridges; however, the Arch bridge type has been determined as the simplest. The fracture critical elements are designed for system redundancy that makes for an advantageous inspection and maintenance. Because less maintenance will be needed on the new bridges, disruptions will be less frequent than what is currently experienced.

## 9.4 Cape Cod Bridges Program Round 4 FAQs

# The Cape Cod Bridges Program



## Round 4 FAQs

### Highway

How will the Entrance/Exit lane on the bridge work? Will vehicles use this lane to avoid congestion?

The Entrance/Exit lanes are necessary safety features due to the short distance between adjacent ramps. The Entrance/Exit lanes provide space for vehicles entering the mainline roadway to safely weave into the through travel lane. They also provide space for vehicles exiting the mainline roadway to safely weave onto the exit ramp. These lanes would only exist between the nearest on ramp on one side of the canal and the nearest off ramp on the other side of the canal.

The short length of the Entrance/Exit lane will not provide an effective means of avoiding anticipated levels of congestion.

Are you increasing roadway capacity through this Program?

The roadways connecting to the bridges on the north and south sides of the canal are not proposed to have an increased number of travel lanes. Therefore, the capacity of the roadways on the north and south sides of the canal will not be increased. Safety and traffic operation improvements are specifically isolated to the bridges and the interchanges immediately north and south of the bridges. These improvements may result in travel time savings crossing the bridges; however, the regional roadway network will be largely unchanged.

Where will the mainline highway be located relative to the current bridges?

At the Round 4 public meetings MassDOT presented an analysis that concluded that mainline roadways located Inboard of the existing bridges will have the least impacts to properties and will have the least impact to the public during construction. In addition to the Inboard options shown at the public meetings, MassDOT evaluated options where the new bridge location would overlap the location of the existing bridge. These alternatives had increased impacts to properties and would result in greater impacts to the public during construction.

What will be the speed limits of the new bridges?

The design criteria used for the mainlines will result in roadways that can support posted speed limits similar to the existing mainline roadways approaching the bridges.

# The Cape Cod Bridges Program



## Impacts

How will you communicate Right of Way impacts to property owners?

MassDOT's Right of Way Bureau will begin communication with affected property owners as soon as possible once Right of Way needs are finalized. If your property, or a portion of it, needs to be acquired, you will be contacted by a representative of the MassDOT Right of Way Bureau to arrange a meeting. At the meeting, our representative will provide you with a right-of-way plan showing the impacts to your property and offer an overview of the Program. They will also explain the acquisition process, review information relative to the property, and document any concerns you may have.

Will my property be impacted?

At this time, Right of Way needs have not been fully identified. MassDOT will be able to better identify anticipated Right of Way needs as design alternatives are advanced. As MassDOT is still evaluating various design alternatives, property impacts will not be known until a preferred design alternative is chosen.

Will the Bourne Rotary be impacted by this Program?

Roadway and interchange alternatives in the vicinity of the Bourne Rotary will be presented at the Round 5 public meetings.

Will there be impacts to utilities?

Yes. These impacts range from major relocations associated with gas and other utilities that are located on the existing bridges to more traditional relocations that are common in roadway reconstruction. MassDOT is in regular contact with Enbridge and National Grid (owners of the gas lines). As the design advances, MassDOT will begin coordination with the other affected utility owners.

## Administration

Are the design recommendations that you have shared final, and can you share more information on the decision-making process?

At the Round 4 public meetings MassDOT described the analysis undertaken to evaluate a range of options for the location of the canal crossings. This analysis concluded that the Inboard option has the least impacts to properties and the least impacts to the public during construction.

The details of this analysis, as well other aspects of the decision-making process, will be included the Environmental Notification Form (ENF) scheduled to be filed with the Massachusetts Environmental Policy Act (MEPA) Office in the Spring. The public will have an opportunity to comment on the ENF. All

# The Cape Cod Bridges Program



comments will be reviewed by the MEPA Office and considered when issuing the scope of the Draft Environmental Impact Report (DEIR)

What is the funding source and cost share for the Program?

At the present time a funding source for the construction of the Program has not been identified. The USACE in cooperation with MassDOT has filed 3 grant applications for funding under the Infrastructure Investment and Jobs Act (IIJA). These federal grants may fund up to 50% to 60% of the cost of the Program depending on the terms of the grant. The grant programs require that the remaining funds (the matching funds) be identified by a proponent at the time the application is submitted. MassDOT and USACE are working to identify these matching funds.

Why was the Program denied funding through its federal grant applications?

On January 31, 2023, the USDOT briefed USACE and MassDOT on the results of their evaluation of the Bridge Investment Program application. According to this briefing, the Cape Cod Bridges Program scored Medium - High in the Project Outcome Criteria category, High in the Economic Analysis Rating category and Low in the Project Readiness category. The Project Readiness category is comprised of three sub-categories. The Cape Cod Bridges Program scored Low in the Financial Completeness sub-category, High in the Technical Assessment sub-category and Medium in the Environmental and Permitting Risk sub-category. USDOT determined that the source of the matching funds was uncertain. As a result of this single Low rating in the Financial Completeness category, USDOT was unable to place the Cape Cod Bridges Program in the Recommended category for grant award.

The IIJA grant opportunities are made available on an annual basis through 2026. USDOT in cooperation with MassDOT intends to apply for all applicable funding opportunities as they become available.

Will the bridges be tolled?

Tolls are not being considered at this time.

## Bridges

What will be the grades of the new bridges?

The roadway grades are proposed to be 4.5% at the Bourne Bridge and 4% at the Sagamore Bridge (4.5 and 4 feet of vertical rise for every 100 feet of horizontal distance).

# The Cape Cod Bridges Program



What will be the widths of the new bridges and why will they be wider than the existing structures?

The existing bridges are very narrow and do not meet current design standards. The existing bridges each have two 10 foot through lanes in each direction with no shoulders and a narrow sidewalk.

The proposed bridges will be designed to meet current design standards. Like the existing bridges, the proposed bridges will include two travel lanes in each direction. However, the proposed travel lanes will be 12 feet wide. Because there will be closely spaced on and off ramps on either side of the canal, continuous entrance/exit lanes are proposed. In addition, 10-foot left side and 4-foot right side shoulders are proposed. Each bridge will also include a shared use path to accommodate bicycle and pedestrian use.

Why will there be two bridges at each crossing instead of one?

There will be two bridges at each crossing because they are more cost effective, structurally efficient structures and allow for staged construction while keeping two lanes of traffic operational in both directions and allowing all existing roadway connections to be maintained. For each crossing, one bridge will carry on-Cape traffic and the other will carry off-Cape traffic. The new crossings will be wider to meet current highway standards, and a single wider structure at each crossing would be difficult to construct and be more costly overall.

Will bridge users be able to have a view of the canal when traveling over the bridge?

The proposed network tied arch replacement bridges will not impede views of the canal and shorelines for vehicular users or pedestrian and bicycle users traveling over the bridge. Careful consideration will be given to the design of the required safety fencing so as to provide as clear a view as is safely possible.

## Construction

Do you have any details on the construction process such as schedule or sequence?

MassDOT is exploring many ways of implementing the construction of the Program. At this early stage of the Program development process, and in the absence of funding, it is too soon to provide detailed information on the number of construction contracts, the order of the contracts or the timing.

Will Project Labor Agreements be used for this Program?

Details regarding the funding, contract packaging, and construction procurement methodology have not been determined. Considering the early stage of program development, policy decisions regarding employing Project Labor Agreements have not been made. However, MassDOT contracts require that the Prevailing Rate or Total Rate must be paid to employees working on projects funded by the



# The Cape Cod Bridges Program



Commonwealth of Massachusetts. A Federal Aid project is also subject to the Federal Minimum Wage Rate law for construction.

## Multimodal

Can you share any detail on the shared use pathway?

The current plan is to have one shared use path at the Bourne crossing and one at the Sagamore crossing. They will be wide enough to safely support bidirectional traffic of bicyclists and pedestrians. This topic will be discussed further at future public meetings as the preliminary design progresses.

After the new bridges are built, can you keep the existing bridge structures in place and use them as bicycle and pedestrian bridges only?

The USACE owns the existing bridges. The USACE has indicated that keeping the bridges in service for bicycle and pedestrian use would require an extensive rehabilitation as well as ongoing maintenance responsibilities and therefore the USACE supports the demolition of the existing bridges.

Both the Bourne and Sagamore Bridge replacements are planned to accommodate bicycle and pedestrian uses.

Can you share any details on how the bridges will perform and be operated during severe wind events?

The proposed bridges will be designed and constructed to withstand the anticipated high wind events, including taking predicted climate change into account. There will be some severe wind events that will require the bridges to be closed to traffic for traveler safety.

Closures will likely be managed similarly to the plan that is currently in place during severe wind events. Through joint discussion, Massachusetts Emergency Management Agency (MEMA), Massachusetts State Police (MSP), MassDOT, and the USACE decide whether to close the bridges based on several factors, including but not limited to wind gusts, sustained wind speeds, traffic back-ups, and projected weather forecasts.

Are there any considerations being given to evacuation needs?

Yes. Initial discussions regarding emergency traffic operations with MassDOT's Highway Operations Section have occurred. As the project development process advances there will be additional coordination.

Will this Program impact MBTA Commuter Rail service?

The Cape Cod Bridges Program is not anticipated to have an impact on MBTA Commuter Rail service.

# The Cape Cod Bridges Program



## Public Involvement

Can you share information on your public involvement process, and explain if there will be increased stakeholder engagement going forward?

MassDOT has continued to undertake a robust public involvement process as part of the Cape Cod Bridges Program. This has included four rounds of public meetings, a comprehensive website with Program information and meeting materials, online tools to submit comments and provide feedback, and briefings with local, state, and federal stakeholders. Going forward, MassDOT is committed to broadening and strengthening its outreach efforts and ensuring that local communities can provide input into the Program development.